

ADJUSTABLE FREQUENCY DRIVES

AF91sv AF DRIVES

- Instruction Manual

Single-phase Input, 200V Class
Three-phase Input, 200V Class
Three-phase Input, 400V Class



Cutler-Hammer

EATON

Safety Messages

For the best results with the AF91sv Series inverter, carefully read this manual and all of the warning labels attached to the inverter before installing and operating it, and follow the instructions exactly. Keep this manual handy for quick reference.

Definitions and Symbols

A safety instruction (message) includes a hazard alert symbol and a signal word, WARNING or CAUTION. Each signal word has the following meaning:



HIGH VOLTAGE: This symbol indicates high voltage. It calls your attention to items or operations that could be dangerous to you and other persons operation this equipment. Read the message and follow the instructions carefully.



This symbol is the “Safety Alert Symbol.” It occurs with either of two signal words: CAUTION or WARNING, as described below.



WARNING: Indicates a potentially hazardous situation which, if not avoided, can result in serious injury or death.



CAUTION: Indicates a potentially hazardous situation which, if not avoided, can result in minor to moderate injury, or serious damage to the product. The situation described in the CAUTION may, if not avoided, lead to serious results. Important safety measures are described in CAUTION (as well as WARNING), so be sure to observe them.



Step 1: Indicates a step in a series of action steps to accomplish a goal.



NOTE: Notes indicate an area or subject of special merit, emphasizing either the product’s capabilities or common errors in operation or maintenance.



TIP: Tips give a special instruction that can save time or provide other benefits while installing or using the product. The tip calls attention to an idea that may not be obvious to first-time users of the product.

Hazardous High Voltage



HIGH VOLTAGE: Motor control equipment and electronic controllers are connected to hazardous line voltages. When servicing drives and electronic controllers, there may be exposed components with housings or protrusions at or above line potential. Extreme care should be taken to protect against shock.

Stand on an insulating pad and make it a habit to use only one hand when checking components. Always work with another person in case an emergency occurs. Disconnect power before checking controllers or performing maintenance. Be sure equipment is properly grounded. Wear safety glasses whenever working on electronic controllers or rotating machinery.

General Precautions - Read These First!



WARNING: This equipment should be installed, adjusted, and serviced by qualified electrical maintenance personnel familiar with the construction and operation of the equipment and the hazards involved. Failure to observe this precaution could result in bodily injury.



WARNING: The user is responsible for ensuring that all driven machinery, drive train mechanism not supplied by Cutler-Hammer, and process line material are capable of safe operation at an applied frequency of 150% of the maximum selected frequency range to the AC motor. Failure to do so can result in destruction of equipment and injury to personnel should a single-point failure occur.



WARNING: For equipment protection, install a ground fault type breaker with a fast response circuit capable of handling large currents. The ground fault protection circuit is not designed to protect against personal injury.



HIGH VOLTAGE: HAZARD OF ELECTRICAL SHOCK. DISCONNECT INCOMING POWER BEFORE WORKING ON THIS CONTROL.



WARNING: Wait at least five (5) minutes after turning off the input power supply before performing maintenance or an inspection. Otherwise, there is the danger of electric shock.



CAUTION: These instructions should be read and clearly understood before working on AF91sv series equipment.



CAUTION: Proper grounds, disconnecting devices and other safety devices and their location are the responsibility of the user and are not provided by Cutler-Hammer.



CAUTION: Be sure to connect a motor thermal cut-off switch or overload device to the AF91sv series controller to assure that the inverter will shut down in the event of an overload or an overheated motor.



HIGH VOLTAGE: Dangerous voltage exists until power light is off. Wait at least 5 minutes after input power is disconnected before performing maintenance.



WARNING: This equipment has high leakage current and must be permanently (fixed) hard-wired to ground via two independent cables.



WARNING: Rotating shafts and above-ground electrical potentials can be hazardous. Therefore, it is strongly recommended that all electrical work conform to the National Electrical Codes and local regulations. Installation, alignment and maintenance should be performed only by qualified personnel. Factory-recommended test procedures included in the instruction manual should be followed. Always disconnect electrical power before working on the unit.



CAUTION:

- a) Class I motor must be connected to protective GND via low resistive path (< 0.1 ohm).
- b) Any motor used must be of a suitable rating.
- c) Motors may have hazardous moving parts. In this event suitable protection must be provided.



CAUTION: Alarm connection may contain hazardous live voltage even when inverter is disconnected. When removing the front cover for maintenance or inspection, confirm that incoming power for alarm connection is completely disconnected.



CAUTION: Hazardous (main) terminals for any interconnection (motor, contact breaker, filter, etc.) must be inaccessible in the final installation.



CAUTION: This equipment should be installed in IP54 or equivalent (see EN60529) enclosure. The end application must be in accordance with BS EN60204-1. Refer to the section on inverter mounting, starting on page 2–6. The diagram dimensions are to be suitably amended for your application.



CAUTION: Connection to field wiring terminals must be reliably fixed having two independent means of mechanical support. Using a termination with cable support (figure below), or strain relief, cable clamp, etc.

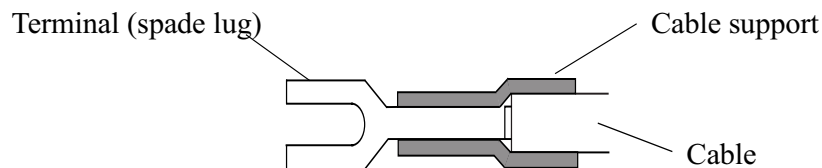

CAUTION: A double-pole disconnection device must be fitted to the incoming main power supply close to the inverter. Additionally, a protection device meeting IEC947-1/IEC947-3 must be fitted at this point (protection device data shown in page 2–13).



NOTE: The above instructions, together with any other requirements are highlighted in this manual, and must be followed for continued LVD (European Low Voltage Directive) compliance.

Precautions for EMC (Electromagnetic Compatibility)

You are required to satisfy the EMC directive (89/336/EEC) when using an AF91sv inverter in a European country. To satisfy the EMC directive and to comply with standard, follow the checklist below.









WARNING: This equipment should be installed, adjusted, and serviced by qualified personal familiar with construction and operation of the equipment and the hazards involved. Failure to observe this precaution could result in bodily injury.





1. The power supply to AF91sv inverter must meet these specifications:
 - a. Voltage fluctuation +/- 10% or less
 - b. Voltage imbalance +/- 3% or less
 - c. Frequency variation +/- 4% or less
 - d. Voltage distortion THD = 10% or less
2. Installation measure:
 - a. Use a filter designed for AF91sv inverter
3. Wiring:
 - a. Shielded wire (screened cable) is required for motor wiring, and the length must be less than 50 meters.
 - b. The carrier frequency setting must be less than 5 kHz to satisfy EMC requirements.
 - c. Separate the main circuit from the signal/process circuit wiring.
4. Environmental conditions - when using a filter, follow these guidelines:
 - a. Ambient temperature: -10 to 40 °C
 - b. Humidity: 20 to 90% RH (non-condensing)
 - c. Vibration: 5.9 m/sec² (0.6 G) 10 ~ 55Hz
 - d. Location: 1000 meters or less altitude, indoors (no corrosive gas or dust)







Index to Warnings and Cautions in This Manual

Installation - Cautions for Mounting Procedures



	CAUTION: Be sure to install the unit on flame-resistant material such as a steel plate. Otherwise, there is the danger of fire. 2-6
	CAUTION: Be sure not to place any flammable materials near the inverter. Otherwise, there is the danger of fire. 2-6
	CAUTION: Be sure not to let the foreign matter enter vent openings in the inverter housing, such as wire clippings, spatter from welding, metal shavings, dust, etc. Otherwise, there is the danger of fire. 2-6
	CAUTION: Be sure to install the inverter in a place which can bear the weight according to the specifications in the text (Chapter 1, Specifications Tables). Otherwise, it may fall and cause injury to personnel. 2-6
	CAUTION: Be sure to install the unit on a perpendicular wall which is not subject to vibration. Otherwise, it may fall and cause injury to personnel. 2-6
	CAUTION: Be sure not to install or operate an inverter which is damaged or has missing parts. Otherwise, it may cause injury to personnel. 2-6
	CAUTION: Be sure to install the inverter in a well-ventilated room which does not have direct exposure to sunlight, a tendency for high temperature, high humidity or dew condensation, high levels of dust, corrosive gas, explosive gas, inflammable gas, grinding-fluid mist, salt damage, etc. Otherwise, there is the danger of fire. 2-6

Wiring - Warnings for Electrical Practices and Wire Specifications

	WARNING: "Use 60/75°C Cu wire only" or equivalent. 2-12
	WARNING: "Open Type Equipment." 2-12
	WARNING: "A Class 2 circuit wired with Class 1 wire" or equivalent. 2-12
	WARNING: "Suitable for use on a circuit capable of delivering not more than 5,000 rms symmetrical amperes, 240 V maximum." For models with suffix B (example: BF25D). 2-12

	WARNING: "Suitable for use on a circuit capable of delivering not more than 5,000 rms symmetrical amperes, 480 V maximum." For models with suffix C (example: CF50D). 2-12
	HIGH VOLTAGE: Be sure to ground the unit. Otherwise, there is a danger of electric shock and/or fire. 2-12
	HIGH VOLTAGE: Wiring work shall be carried out only by qualified personnel. Otherwise, there is a danger of electric shock and/or fire. 2-12
	HIGH VOLTAGE: Implement wiring after checking that the power supply is off. You may incur electric shock and/or fire. 2-12
	HIGH VOLTAGE: Do not connect wiring to an inverter or operate an inverter that is not mounted according the instructions given in this manual. Otherwise, there is a danger of electric shock and/or injury to personnel. 2-12
	WARNING: Make sure the input power to the inverter is off. If the drive has been powered, leave it off for five minutes before continuing. 2-16



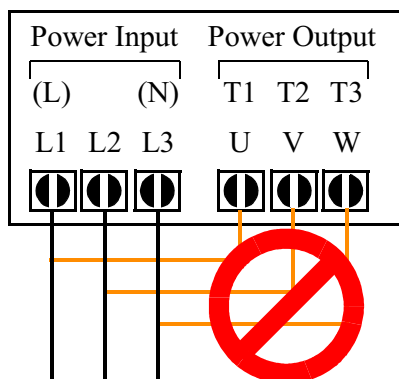

Wiring - Cautions for Electrical Practices

	CAUTION: Be sure that the input voltage matches the inverter specifications: • Single/Three phase 200 to 240 V 50/60 Hz (up to 2.2kW) • Three phase 200 to 230V 50/60Hz (above 2.2kW) • Three phase 380 to 460 V 50/60Hz 2-14
	CAUTION: Be sure not to input a single phase to a three-phase-only type inverter. Otherwise, there is the danger of fire. 2-14
	CAUTION: Be sure not to connect an AC power supply to the output terminals. Otherwise, there is the danger of injury and/or fire. 2-14







NOTE:













L, N: Single-phase 200 to 240V 50/60 Hz
L1, L2, L3: Three-phase 200 to 240V 50/60 Hz
Three-phase 380 to 460V 50/60 Hz



-  CAUTION: Fasten the screws with the specified fastening torque 2-15
(see the following table). Check for any loosening of screws. Otherwise, there is the danger of fire.
-  CAUTION: Remarks for using ground fault circuit breakers in the 2-15
main power supply: Adjustable frequency drives with CE-filters (RFI-filter) and shielded (screened) motor cables have a higher leakage current toward GND. Especially at the moment of switching on this can cause inadvertent tripping of ground fault circuit breakers. Because of the rectifier on the input side of the inverter there is the possibility to stall the switch-off function through small amounts of DC current. Please observe the following: • Use only short time-invariant and pulse current-sensitive ground fault circuit breakers with higher trigger current. • Other components should be secured with separate ground fault circuit breakers. • Ground fault circuit breakers in the power input wiring of an inverter are not an absolute protection against electric shock by direct touching.
-  CAUTION: Be sure to install a fuse in the wire for each phase of 2-15
the main power supply to the inverter. Otherwise, there is the danger of fire.
-  CAUTION: For motor leads, ground fault breakers and electromag- 2-15
netic contactors, be sure to size these components properly (each must have the capacity for rated current and voltage). Otherwise, there is the danger of fire.

Powerup Test Caution Messages





-  CAUTION: The heat sink fins will have a high temperature. Be 2-17
careful not to touch them. Otherwise, there is the danger of getting burned.
-  CAUTION: The operation of the inverter can be easily changed 2-17
from low speed to high speed. Be sure check the capability and limitations of the motor and machine before operating the inverter. Otherwise, there is the danger of injury.
-  CAUTION: If you operate a motor at a frequency higher than the 2-18
inverter standard default setting (50Hz/60Hz), be sure to check the motor and machine specifications with the respective manufacturer. Only operate the motor at elevated frequencies after getting their approval. Otherwise, there is the danger of equipment damage.
-  CAUTION: Check the following before and during the powerup 2-18
test. Otherwise, there is the danger of equipment damage. • Is the shorting bar between the +1 and + terminals installed? DO NOT power or operate the inverter if the jumper is removed. • Is the direction of the motor correct? • Did the inverter trip during acceleration or deceleration? • Were the rpm and frequency meter readings as expected? • Were there any abnormal motor vibrations or noise?

Warnings for Operations and Monitoring





	WARNING: Be sure to turn on the input power supply after closing the front case. While being energized, be sure not to open the front case. Otherwise, there is the danger of electric shock. 4-3
	WARNING: Be sure not to operate the switches with wet hands. Otherwise, there is the danger of electric shock. 4-3
	WARNING: While the inverter is energized, be sure not to touch the inverter terminals even when the motor is stopped. Otherwise, there is the danger of electric shock. 4-3
	WARNING: If the Retry Mode is selected, the motor may suddenly restart during the trip stop. Do not approach the machine (be sure to design the machine so that safety for personnel is secure even if it restarts.) Otherwise, it may cause injury to personnel. 4-3
	WARNING: If the power supply is cut off for a short period of time, the inverter may restart operation after the power supply recovers if the command to operate is active. If a restart may pose danger to personnel, so be sure to use a lock-out circuit so that it will not restart after power recovery. Otherwise, it may cause injury to personnel. 4-3
	WARNING: The Stop Key is effective only when the Stop function is enabled. Be sure to enable the Key separately from the emergency stop. Otherwise, it may cause injury to personnel. 4-3
	WARNING: After the operation command is given, if the alarm reset is conducted, it will restart suddenly. Be sure to set the alarm reset after verifying the operation command is off. Otherwise, it may cause injury to personnel. 4-3
	WARNING: Be sure not to touch the inside of the energized inverter or to put any conductive object into it. Otherwise, there is a danger of electric shock and/or fire. 4-3
	WARNING: When the power is turned on when the running command is already active, the motor will suddenly start rotation and is dangerous. Before turning the power on, confirm that the running command is not enabled. 4-3
	WARNING: When the Stop key function is disabled, pressing the Stop key does not cancel the stop and trip. 4-3
	WARNING: Be sure to provide a separate, hard-wired emergency stop switch. When the operation command source is a digital operator, this selection is ineffective. 4-3
	WARNING: If the power is turned on and the Run command is already active, the motor starts rotation and is dangerous! Before turning power on, confirm that the Run command is not active. 4-6

-  **WARNING:** After the Reset command is given and the alarm reset occurs, the motor will restart suddenly if the Run command is already active. Be sure to set the alarm reset after verifying that the Run command is off to prevent injury to personnel. 4-18
-  **WARNING:** You may need to disconnect the load from the motor before performing auto-tuning. The inverter runs the motor forward and backward for several seconds without regard to load movement limits. 4-30

Cautions for Operations and Monitoring

-  **CAUTION:** The heat sink fins will have a high temperature. Be careful not to touch them. Otherwise, there is the danger of getting burned. 4-2
-  **CAUTION:** The operation of the inverter can be easily changed from low speed to high speed. Be sure check the capability and limitations of the motor and machine before operating the inverter. Otherwise, it may cause injury to personnel. 4-2
-  **CAUTION:** If you operate a motor at a frequency higher than the inverter standard default setting (50Hz/60Hz), be sure to check the motor and machine specifications with the respective manufacturer. Only operate the motor at elevated frequencies after getting their approval. Otherwise, there is the danger of equipment damage. 4-2
-  **CAUTION:** It is possible to damage the inverter or other devices in your application if the maximum current or voltage characteristics of a connection point are exceeded. 4-4

Warnings and Cautions for Troubleshooting and Maintenance

-  **WARNING:** Wait at least five (5) minutes after turning off the input power supply before performing maintenance or an inspection. Otherwise, there is the danger of electric shock. 6-2
-  **WARNING:** Make sure that only qualified personnel will perform maintenance, inspection, and part replacement. (Before starting to work, remove any metallic objects from your person (wristwatch, bracelet, etc.). Be sure to use tools with insulated handles. Otherwise, there is a danger of electric shock and/or injury to personnel. 6-2
-  **WARNING:** Never remove connectors by pulling on its wire leads (wires for cooling fan and logic p.c.board). Otherwise, there is a danger of fire or injury due to wire breakage. 6-2
-  **CAUTION:** When removing connectors, never pull the wires (wires for the cooling fan and logic P.C. board). Otherwise, there is danger of fire due to wire breakage and/or injury to personnel. 6-2



CAUTION: Never test the withstand voltage (HIPOT) on the inverter. The inverter has a surge protector between the main circuit terminals above and the chassis ground.

..... 6-12



HIGH VOLTAGE: Be careful not to touch wiring or connector terminals when working with the inverters and taking measurements. Be sure to place the measurement circuitry above in an insulated housing before using them.

..... 6-13

General Warnings and Cautions



WARNING: Never modify the unit. Otherwise, there is a danger of electric shock and/or injury.



CAUTION: Withstand voltage tests and insulation resistance tests (HIPOT) are executed before the units are shipped, so there is no need to conduct these tests before operation.



CAUTION: Do not attach or remove wiring or connectors when power is applied. Also, do not check signals during operation.



CAUTION: Do not stop operation by switching off electromagnetic contactors on the primary or secondary sides of the inverter.

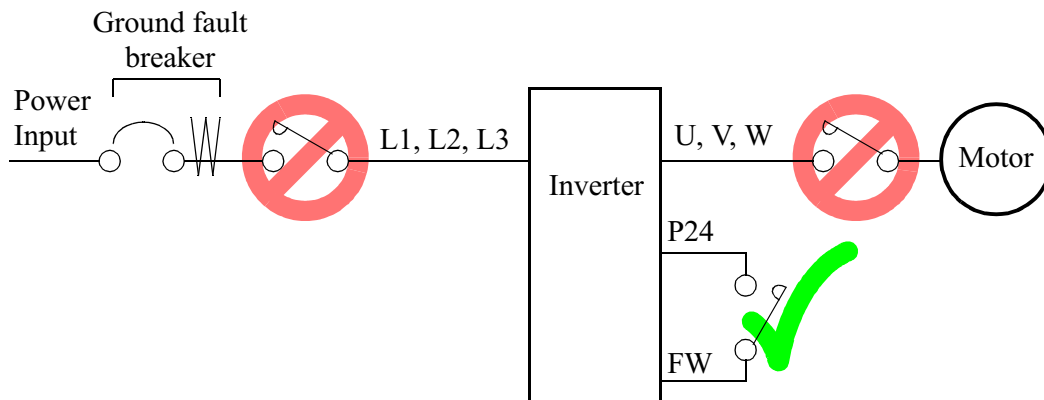

When there has been a sudden power failure while an operation instruction is active, then the unit may restart operation automatically after the power failure has ended. If there is a possibility that such an occurrence may harm humans, then install an electromagnetic contactor (Mgo) on the power supply side, so that the circuit does not allow automatic restarting after the power supply recovers. If the optional remote operator is used and the retry function has been selected, this will also cause automatic restarting when an operation instruction is active. So, please be careful.



CAUTION: Do not insert leading power factor capacitors or surge absorbers between the output terminals of the inverter and motor.

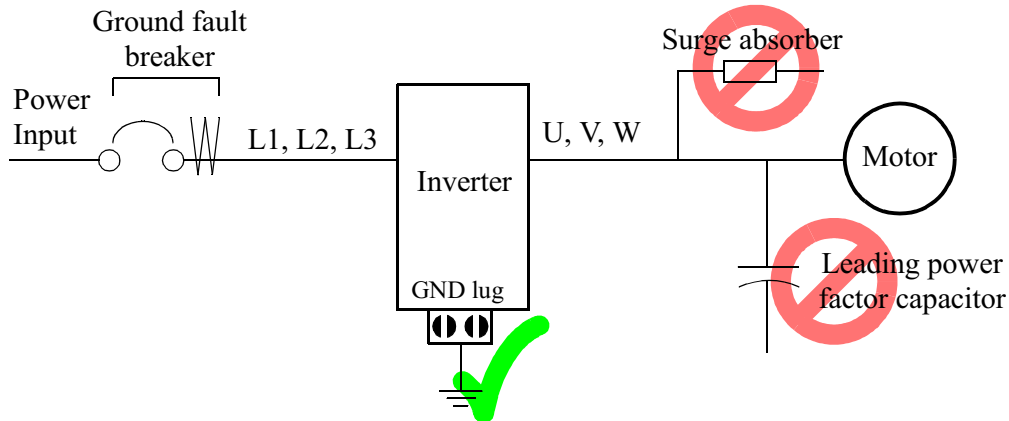

CAUTION: Be sure to connect the grounding terminal to ground.



CAUTION: When inspecting the unit, be sure to wait five minutes after tuning off the power supply before opening the cover.



CAUTION: MOTOR TERMINAL SURGE VOLTAGE SUPPRESSION FILTER (For the 400 V CLASS)

In a system using an inverter with the voltage control PWM system, a voltage surge caused by the cable constants such as the cable length (especially when the distance between the motor and inverter is 10 m or more) and cabling method may occur at the motor terminals. A dedicated filter of the 400 V class for suppressing this voltage surge is available. Be sure to install a filter in this situation.



CAUTION: SUPPRESSION FOR NOISE INTERFERENCE FROM INVERTER

The inverter uses many semiconductor switching elements such as transistors and IGBTs. Thus, a radio receiver or measuring instrument located near the inverter is susceptible to noise interference.

To protect the instruments from erroneous operation due to noise interference, they should be used well away from the inverter. It is also effective to shield the whole inverter structure.

The addition of an EMI filter on the input side of the inverter also reduces the effect of noise from the commercial power line on external devices.

Note that the external dispersion of noise from the power line can be minimized by connecting an EMI filter on the primary side of inverter.



CAUTION: EFFECTS OF DISTRIBUTOR LINES ON INVERTERS

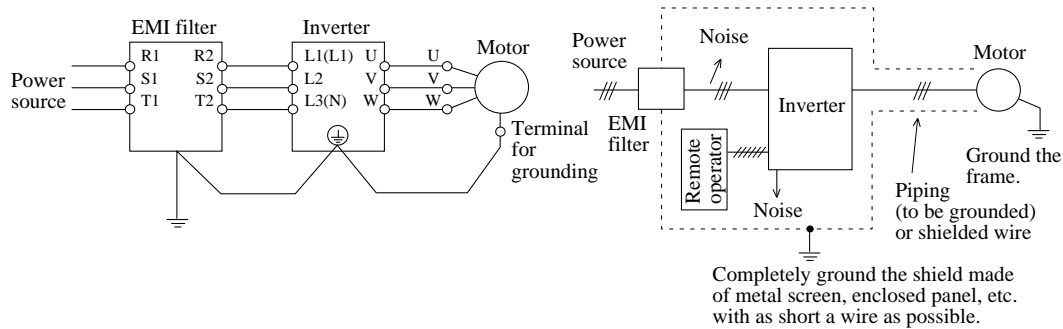

In the cases below involving a general-purpose inverter, a large peak current flows on the power supply side, sometimes destroying the converter module. Where such situations are foreseen, or the paired equipment must be highly reliable, install an AC reactor between the power supply and the inverter.

1. The unbalance factor of the power supply is 3% or higher.
2. The power supply capacity is at least 10 times greater than the inverter capacity (and the power supply capacity, 500 kVA or more).
3. Abrupt power supply changes are expected.

Some examples include:

- a. Several inverters are interconnected with a short bus.
- b. A thyristor converter and an inverter are interconnected with a short bus.
- c. An installed phase advance capacitor opens and closes.

In cases (1), (2), and (3) we recommend installing an AC reactor of 3% (at a voltage drop at rated current) with respect to the supply voltage on the power supply side.



CAUTION: When the EEPROM error E8 occurs, be sure to confirm the setting value again.

CAUTION: When setting b contact to the forward or reverse command [FW], [RV] terminal, the inverter starts automatically. Do not set to b contact without a purpose.

General Caution



CAUTION: In all the illustrations in this manual, covers and safety devices are occasionally removed to describe the details. While operating the product, make sure that the covers and safety devices are placed as they were specified originally and operate it according to the instruction manual.

Table of Contents

Safety Messages	i
Hazardous High Voltage	i
General Precautions - Read These First!	ii
Precautions for EMC (Electromagnetic Compatibility)	iv
Index to Warnings and Cautions in This Manual	v
General Warnings and Cautions	x
Revisions	xv

Chapter 1: Getting Started

Introduction	1-2
AF91sv Inverter Specifications	1-4
Introduction to Adjustable Frequency Drives	1-15
Frequently Asked Questions	1-20

Chapter 2: Inverter Mounting and Installation

Orientation to Inverter Features	2-2
Basic System Description	2-5
Step-by-Step Basic Installation	2-6
Powerup Test	2-17
Using the Front Panel Keypad	2-19

Chapter 3: Configuring Drive Parameters

Choosing a Programming Device	3-2
Using Keypad Devices	3-3
“D” Group: Monitoring Functions	3-6
“F” Group: Main Profile Parameters	3-7
“A” Group: Standard Functions	3-8
“B” Group: Fine Tuning Functions	3-19
“C” Group: Intelligent Terminal Functions	3-26
“H” Group: Sensorless Vector Functions	3-34

Chapter 4: Operations and Monitoring

Introduction	4-2
Connecting to PLCs and Other Devices	4-4
Using Intelligent Input Terminals	4-6
Using Intelligent Output Terminals	4-21
Analog Input Operation	4-27
Analog and Digital Monitor Output	4-28
Auto-tuning for Sensorless Vector Control	4-30
PID Loop Operation	4-33
Configuring the Inverter for Multiple Motors	4-34

Chapter 5: Motor Control Accessories

Introduction	5-2
Component Descriptions	5-3

Chapter 6: Troubleshooting and Maintenance

Troubleshooting	6-2
Monitoring Trip Events, History, & Conditions	6-5
Restoring Factory Default Settings	6-8
Maintenance and Inspection	6-9

Appendix A: Glossary and Bibliography

Glossary	A-2
Bibliography	A-8

Appendix B: Drive Parameter Settings Tables

Introduction	B-2
Parameter Settings for Keypad Entry	B-2
Parameter Settings for Copy Unit Entry	B-9

Index

Revisions

Revision History Table

No.	Revision Comments	Date of Issue	Operation Manual No.
	Initial release of manual for AF91sv	December 2000	TD.08H.37.T.E
1	Minor typographical corrections in manual body New back cover text	December 2000	TD.08H.37A.T.E
2	Minor corrections in caution notes, tables, and dimension drawings	January 2001	TD.08H.37B.T.E

Getting Started



In This Chapter....	page
— Introduction	2
— AF91sv Inverter Specifications.....	4
— Introduction to Adjustable Frequency Drives .	15
— Frequently Asked Questions	20

Introduction

Main Features

Congratulations on your purchase of an AF91sv Series Cutler-Hammer inverter! This inverter drive features state-of-the-art circuitry and components to provide high performance. The housing footprint is exceptionally small, given the size of the corresponding motor. The Cutler-Hammer AF91sv product line includes more than a dozen inverter models to cover motor sizes from 1/4 horsepower to 10 horsepower, in either 230 VAC or 460 VAC power input versions. The main features are:

- Convenient keypad for parameter settings
- Built-in RS-422 communications interface to allow configuration from a PC and for field bus external modules.
- Sixteen programmable speed levels
- Motor constants are programmable, or may be set via auto-tuning
- PID control adjusts motor speed automatically to maintain a process variable value

The design in Cutler-Hammer inverters overcomes many of the traditional trade-offs between speed, torque and efficiency. The performance characteristics are:

- Sensorless vector control
- Regenerative braking circuit
- High starting torque of 200% rating or greater
- Continuous torque operation at 100% within a 1:10 speed range (6/60 Hz / 5/50 Hz) without motor derating
- Fan has On/OFF selection to provide longer life for cooling fan (on models with fan)

A full line of accessories from Cutler-Hammer is available to complete your motor application. These include:

- Digital remote operator keypad
- Braking resistors
- Radio noise filters
- CE compliance filters
- DIN rail mounting adapter (35mm rail size)



Model AV91AG0B001D

Inverter Specifications Label

The Cutler-Hammer AF91sv inverters have product labels located on the right side of the housing, as pictured below. Be sure to verify that the specifications on the labels match your power source, motor, and application safety requirements.

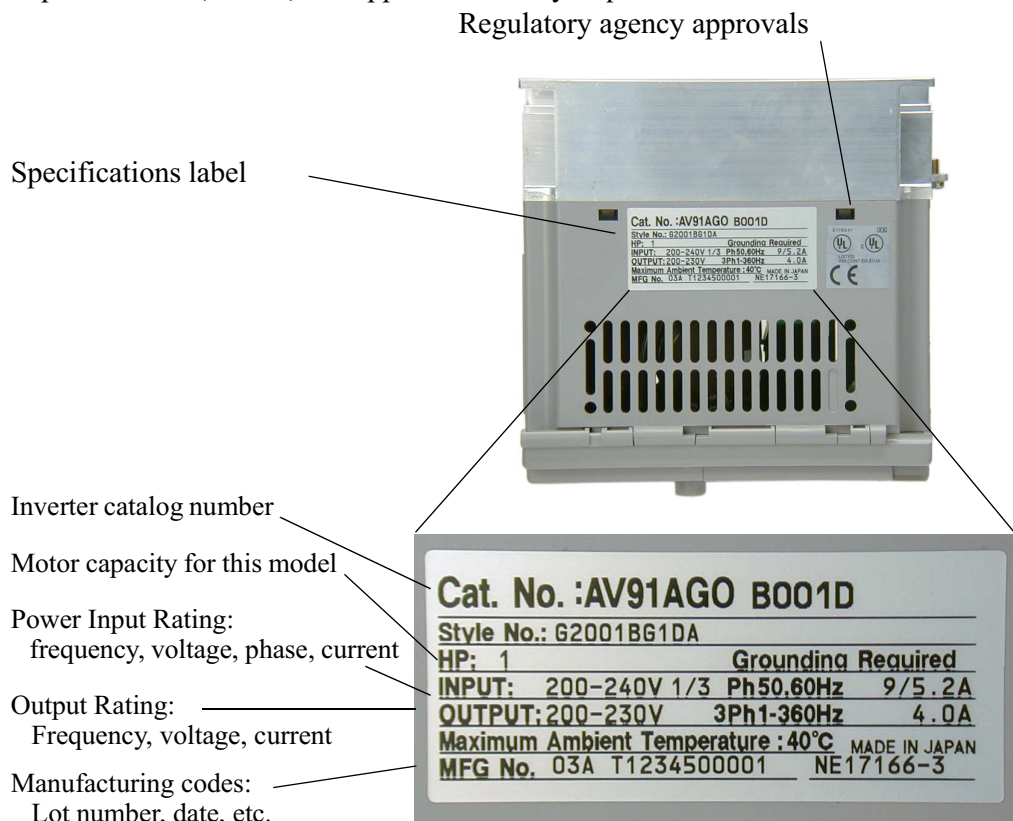

Model Number Convention

The model number for a specific inverter contains useful information about its operating characteristics. Refer to the model number legend below:

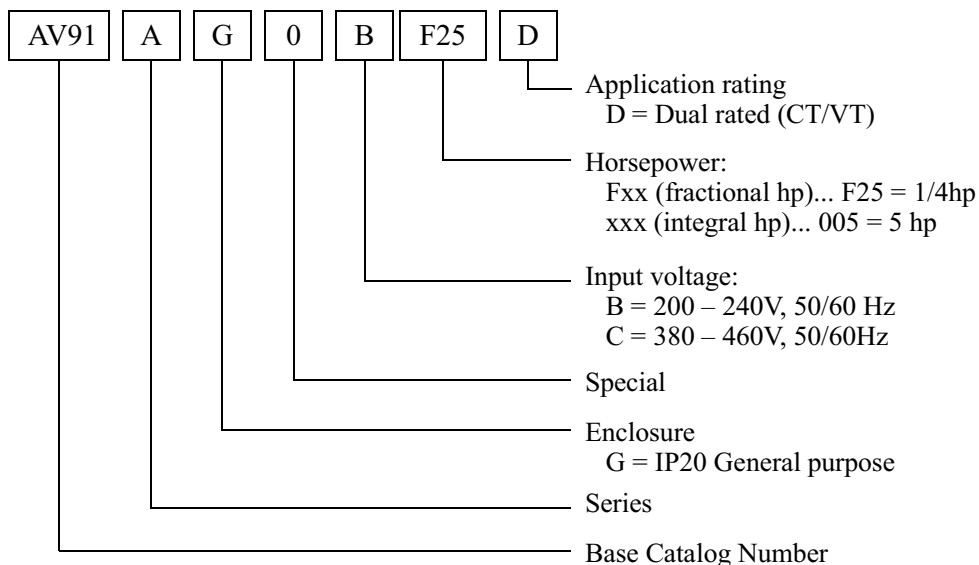

AF91sv Inverter Specifications

Model-specific tables for 200V and 400V class inverters

The following three tables are specific to AF91sv inverters for the 200V and 400V class model groups. The table on page 1-6 gives the general specifications that apply to both voltage class groups. Footnotes for all specifications tables are on the next page.

Item		200V Class Specifications			
AF91sv inverters, 200V models, Catalog number AV91AG0...		BF25D	BF50D	B001D	B002D
Applicable motor size *2	kW	0.2	0.4	0.75	1.5
	HP	1/4	1/2	1	2
Rated capacity (230/240V) kVA *12		0.6 / 0.6	1.0 / 1.0	1.5 / 1.6	3.1 / 3.0
Rated input voltage		1-phase: 200 to 240V +5%/-10%, 3-phase: 200 to 220/200 to 230V ±10%, 50/60 Hz ±5%			
Rated input current (A), (1-ph / 3-ph)		3.5 / 2.0	5.8 / 3.4	9.0 / 5.2	17.5 / 10.0
Rated output voltage *3		3-phase 200 to 240V (corresponding to input voltage)			
Rated output current (A)		1.6	2.6	4.0	8.0
Starting torque *6		200% or more			
Dynamic braking approx. % torque, short time stop *7	without resistor, from 50 / 60 Hz	100%: ≤ 50Hz 50%: ≤ 60Hz			70%: ≤ 50Hz 30%: ≤ 60Hz
	with resistor	150%			
DC braking		Variable operating frequency, time, and braking force			
Weight	kg / lb	0.7 / 1.5	0.8 / 1.8	1.3 / 2.9	2.3 / 5.1

Item		200V Class Specifications, continued			
AF91sv inverters, 200V models, Catalog Number AV91AG0...		B003D	B005D	B007D	B010D
Applicable motor size *2	kW	2.2	3.7	5.5	7.5
	HP	3	5	7.5	10
Rated capacity (230/240V) kVA *12		4.3 / 4.5	6.9 / 7.2	9.5 / 9.9	12.7 / 13.3
Rated input voltage		1-phase: 200 to 240V +5%/-10%, 3-phase: 200 to 220/200 to 230V ±10%, 50/60 Hz ±5%, (B005D, B007D, B010D 3-phase only)			
Rated input current (A), (1-ph / 3-ph)		24.0 / 14.0	- / 22.0	- / 30.0	- / 40.0
Rated output voltage *3		3-phase 200 to 240V (corresponding to input voltage)			
Rated output current (A)		11.0	17.5	24	32
Starting torque *6		200% or more	180% or more		
Dynamic braking approx. % torque, short time stop *7	without resistor, from 50 / 60 Hz	20%: ≤ 50Hz 20%: ≤ 60Hz		20%: ≤ 50Hz 20%: ≤ 60Hz	
	with resistor	100%		80%	
DC braking		Variable operating frequency, time, and braking force			
Weight	kg / lb	2.8 / 6.2	2.8 / 6.2	5.5 / 12.1	5.7 / 12.5

Item		400V Class Specifications						
AF91sv inverters, 400V models, Catalog Number AV91AG0...		CF50D	C001D	C002D	C003D	C005D	C007D	C010D
Applicable motor size *2	kW	0.4	0.75	1.5	2.2	4.0	5.5	7.5
	HP	1/2	1	2	3	5	7.5	10
Rated capacity (460V) kVA		1.1	1.9	2.9	4.2	6.6	10.3	12.7
Rated input voltage		3-phase: 380 to 415/400 to 460V $\pm 10\%$, 50/60 Hz $\pm 5\%$						
Rated input current (A)		2.0	3.3	5.0	7.0	11.0	16.5	20.0
Rated output voltage *3		3-phase: 380 to 415/400 to 460V (corresponding to input voltage)						
Rated output current (A)		1.5	2.5	3.8	5.5	8.6	13	16
Starting torque *6		200% or more				180% or more		
Dynamic braking approx. % torque, short time stop *7	without resistor, from 50/60 Hz	100%: $\leq 50\text{Hz}$ 50%: $\leq 60\text{Hz}$			40%: $\leq 50\text{Hz}$ 20%: $\leq 60\text{Hz}$		20%: $\leq 50\text{Hz}$ 20%: $\leq 60\text{Hz}$	
	with resistor	150%			100%		80%	
DC braking		Variable operating frequency, time, and braking force						
Weight	kg / lb	1.3/2.9	1.7/3.7	1.7/3.7	1.8/4.0	2.8/6.2	5.5/12.1	5.7/12.5

Footnotes for the preceding tables and the table on the following page:

- *1: The front panel protection method conforms to JEM 1030 / IP65.
- *2: The applicable motor refers to NEMA standard 3-phase motor (4-pole). To use other motors, care must be taken to prevent the rated motor current (50/60 Hz) from exceeding the rated output current of the inverter.
- *3: The output voltage decreases as the main supply voltage decreases (except for use of the AVR function). In any case, the output voltage cannot exceed the input power supply voltage.
- *4: To operate the motor beyond 50/60 Hz, consult the motor manufacturer about the maximum allowable rotation speed.
- *5: SLV selected, set carrier frequency more than 2.1 kHz.
- *6: At the rated voltage when using a NEMA standard 3-phase, 4-pole motor (when selecting high starting torque flux vector control).
- *7: The braking torque via capacitive feedback is the average deceleration torque at the shortest deceleration (stopping from 50/60 Hz as indicated). It is not continuous regenerative braking torque. And, the average deceleration torque varies with motor loss. This value decreases when operating beyond 50 Hz. If a large regenerative torque is required, the optional regenerative braking resistor should be used.
- *8: The frequency command is the maximum frequency at 9.8V for input voltage 0 to 10 VDC, or at 19.6 mA for input current 4 to 20 mA. If this characteristic is not convenient for your application, contact your Cutler-Hammer sales representative.
- *9: If operating the inverter at 40 to 50° C, reduce the carrier frequency to 2.1 kHz, derate the output current by 80%, and remove the top housing cover. Note that removing the top cover will nullify the NEMA rating for the inverter housing.
- *10: The storage temperature refers to the short-term temperature during transport.
- *11: Conforms to the test method specified in JIS C0911 (1984). For the model types excluded in the standard specifications, contact your Cutler-Hammer sales representative.
- *12: The input voltage of AV91AG0BxxxD is 230V.

General Specifications

The following table applies to all AF91sv inverters.

Item		General Specifications	
Protective housing *1		IP20 / NEMA 1	
Control method		Sine wave pulse-width modulation (PWM) control	
Output frequency range *4		0.5 to 360 Hz	
Frequency accuracy		Digital command: 0.01% of the maximum frequency Analog command: 0.1% of the maximum frequency (25°C ± 10°C)	
Frequency setting resolution		Digital: 0.1 Hz; Analog: max. frequency/1000	
Volt./Freq. characteristic *5		V/F optionally variable, V/F control (constant torque, reduced torque), sensorless vector control	
Overload current rating		150%, 60 seconds	
Acceleration/deceleration time		0.1 to 3000 sec., (linear accel/decel), second accel/decel setting available	
Input signal	Freq. setting	Operator panel	Up and Down keys / Value settings
		Potentiometer	Analog setting
		External signal *8	0 to 10 VDC (input impedance 10k Ohms), 4 to 20 mA (input impedance 250 Ohms), Potentiometer (1k to 2k Ohms, 2W)
	FWD/REV Run	Operator panel	Run/Stop (Forward/Reverse run change by command)
		External signal	Forward run/stop, Reverse run/stop
Intelligent input terminal		FW (forward run command), RV (reverse run command), CF1~CF4 (multi-stage speed setting), JG (jog command), 2CH (2-stage accel./decel. command), FRS (free run stop command), EXT (external trip), USP (startup function), SFT (soft lock), AT (analog current input select signal), RS (reset), PTC (thermal protection), DB (external DC braking command), SET (2nd setting selection), UP (remote control, accel.), DWN (remote control, decel.)	
Output signal	Intelligent output terminal	RUN (run status signal), FA1,2 (frequency arrival signal), OL (overload advance notice signal), OD (PID error deviation signal), AL (alarm signal)	
	Frequency monitor	PWM output; Select analog output frequency monitor, analog output current monitor or digital output frequency monitor	
Alarm output contact		ON for inverter alarm (1C contacts, both normally open or closed avail.)	
Other functions		AVR function, curved accel/decel profile, upper and lower limiters, 16-stage speed profile, fine adjustment of start frequency, carrier frequency change (0.5 to 16 kHz) frequency jump, gain and bias setting, process jogging, electronic thermal level adjustment, retry function, trip history monitor, 2nd setting selection, auto tuning, fan on/off selection	
Protective function		Over-current, over-voltage, under-voltage, overload, extreme high/low temperature, CPU error, memory error, ground fault detection at startup, internal communication error, electronic thermal, CT error	
Operating Environment	Ambient storage humidity	-10 to 50°C (*9) / -25 to 70°C (*10) / 20 to 90% humidity (non-condensing)	
	Vibration *11	5.9 m/s ² (0.6G), 10 to 55 Hz	
	Location	Altitude 1,000 m or less, indoors (no corrosive gasses or dust)	
Coating color		Dark gray; cooling fins in base color of aluminum	
Options		Remote operator unit, copy unit, cables for the units, braking unit, braking resistor, AC reactor, DC reactor, noise filter, DIN rail mounting	

Derating Curves

The maximum available inverter current output is limited by the carrier frequency and ambient temperature. The carrier frequency is the inverter’s internal power switching frequency, settable from 0.5 kHz to 15 kHz. Choosing a higher carrier frequency tends to decrease audible noise, but it also increases the internal heating of the inverter, thus decreasing (derating) the maximum current output capability. Ambient temperature is the temperature just outside the inverter housing — such as inside the control cabinet where the inverter is mounted. A higher ambient temperature decreases (derates) the inverter’s maximum current output capacity.

Use the following derating curves to help determine the optimal carrier frequency setting for your inverter, and to find the output current derating. Be sure to use the proper curve for your particular AF91sv inverter model number.

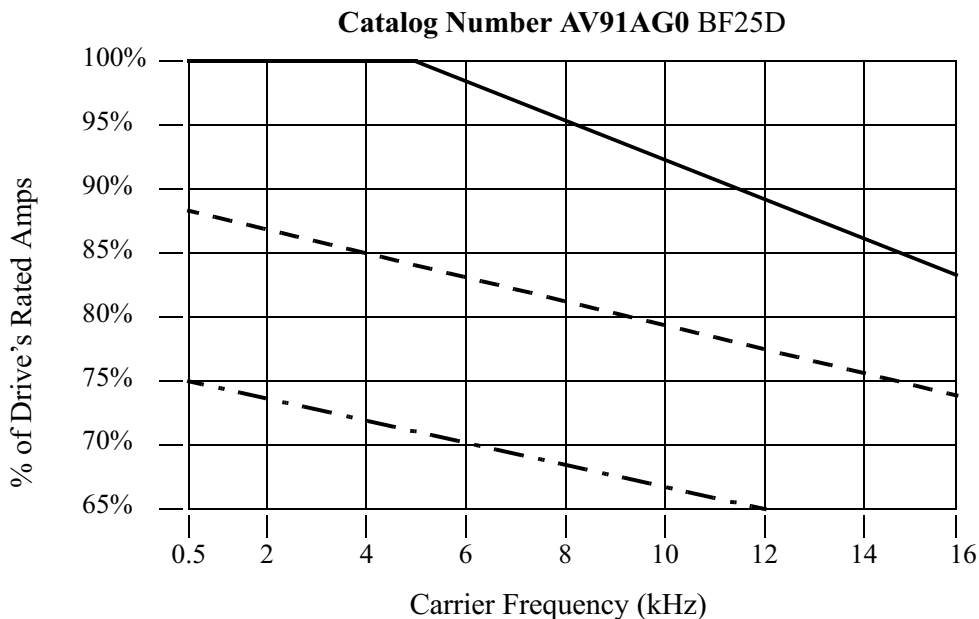
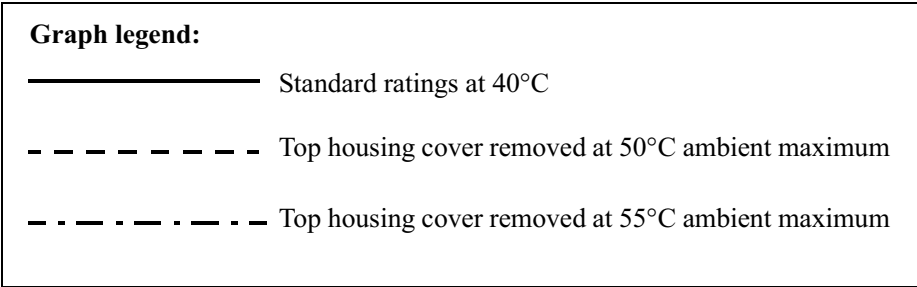

Catalog Number AV91AG0 BF50D

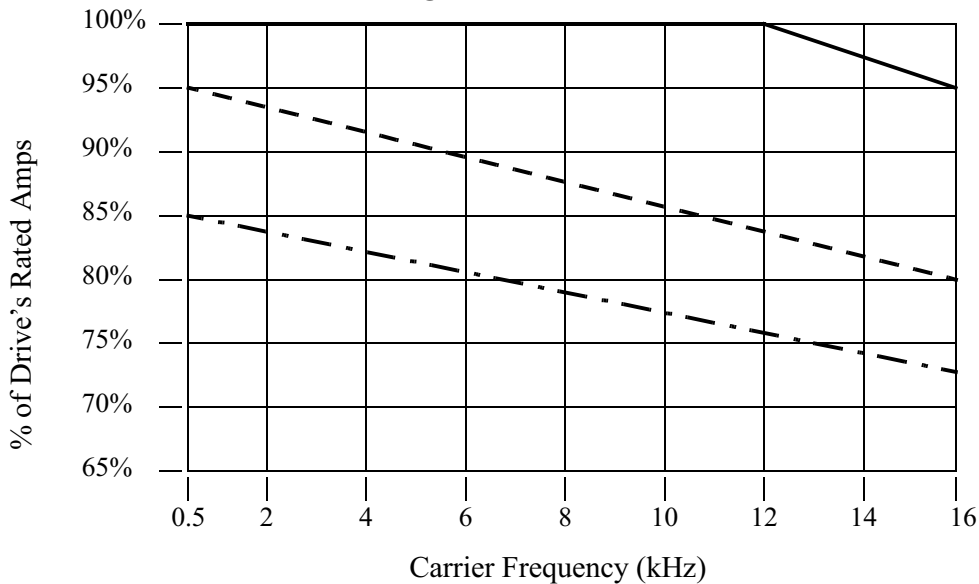

Catalog Number AV91AG0 B001D

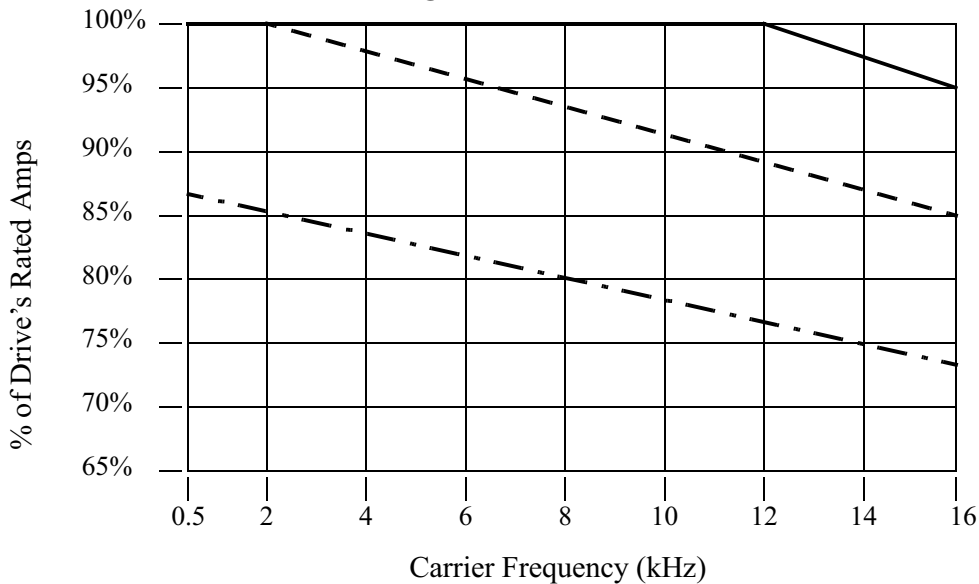

Catalog Number AV91AG0 B002D

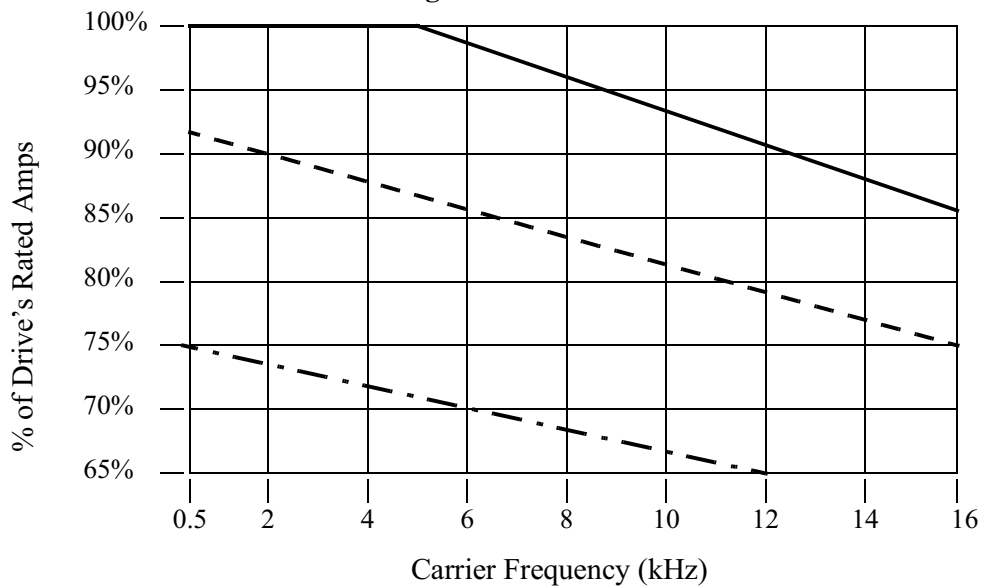

Catalog Number AV91AG0 B003D

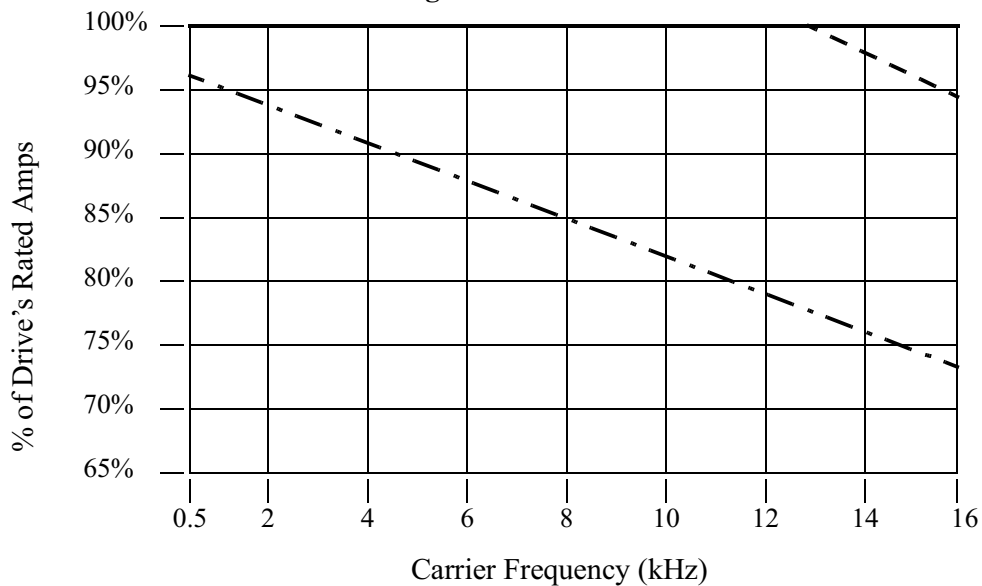

Catalog Number AV91AG0 B005D

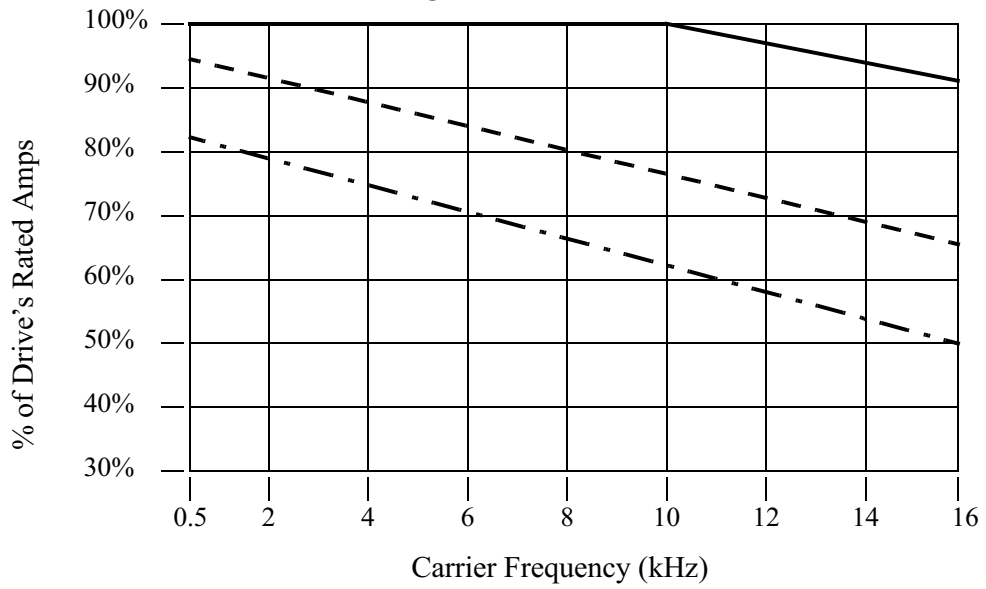

Catalog Number AV91AG0 CF50D

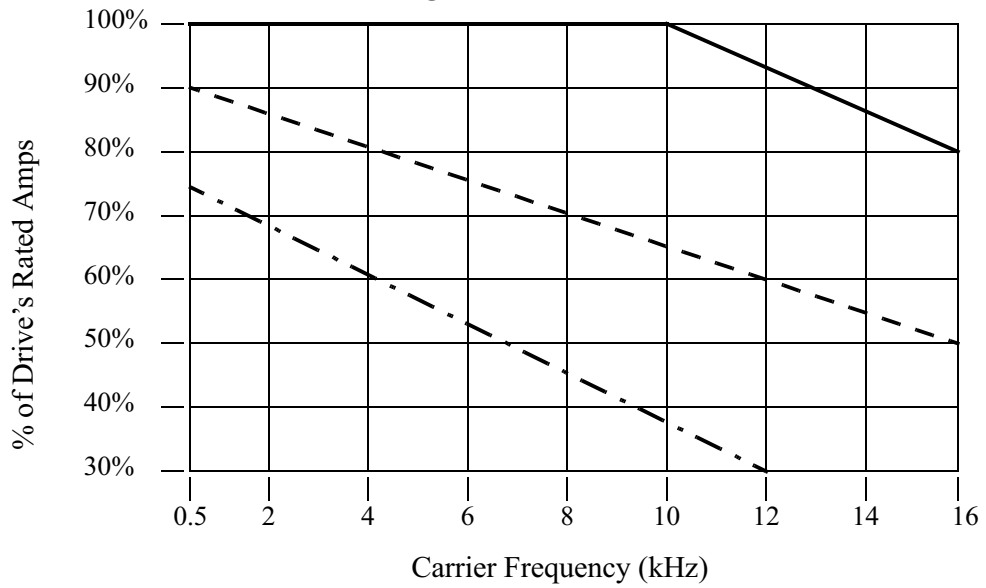

Catalog Number AV91AG0 C001D

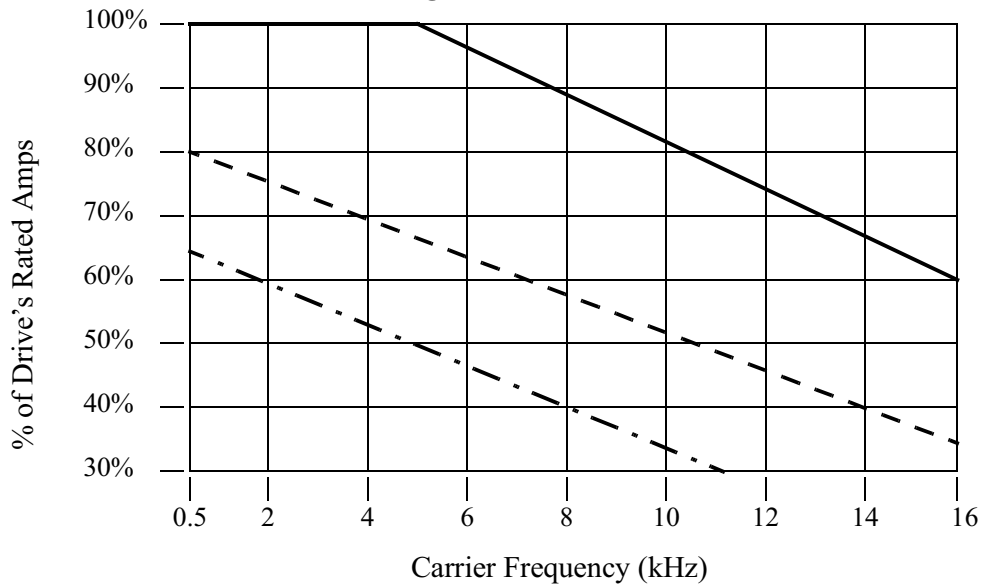

Catalog Number AV91AG0 C002D

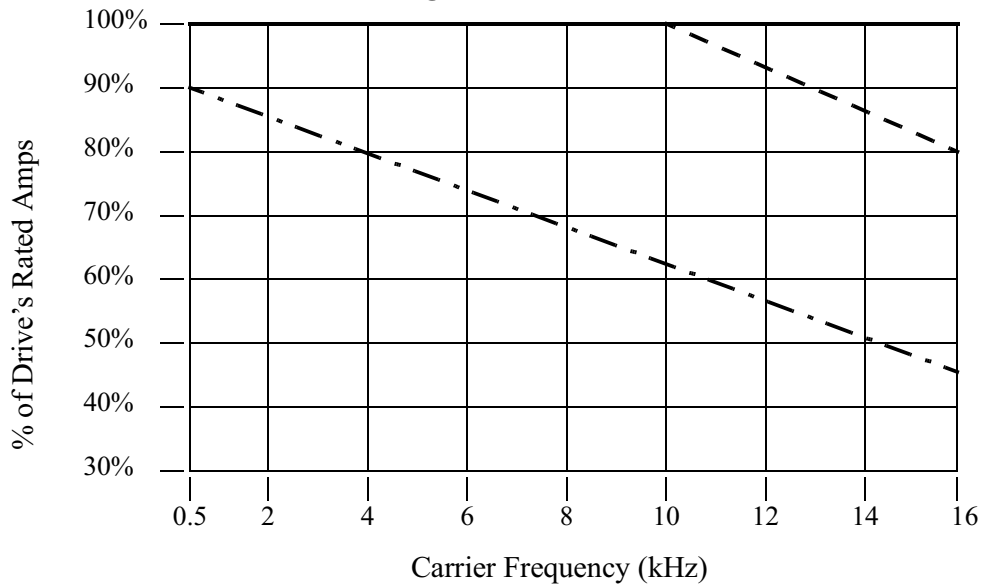

Catalog Number AV91AG0 C003D

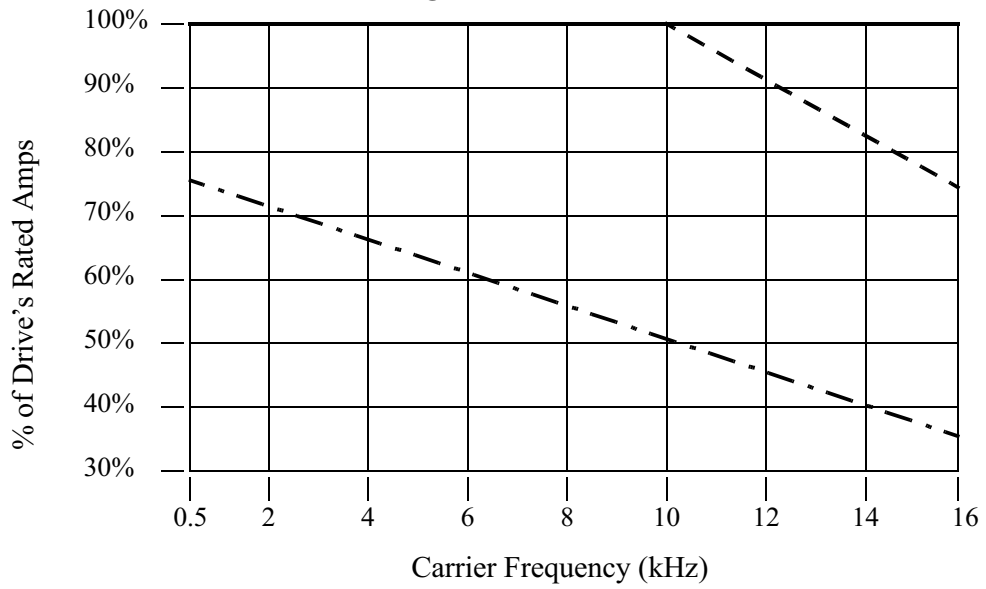

Catalog Number AV91AG0 C005D

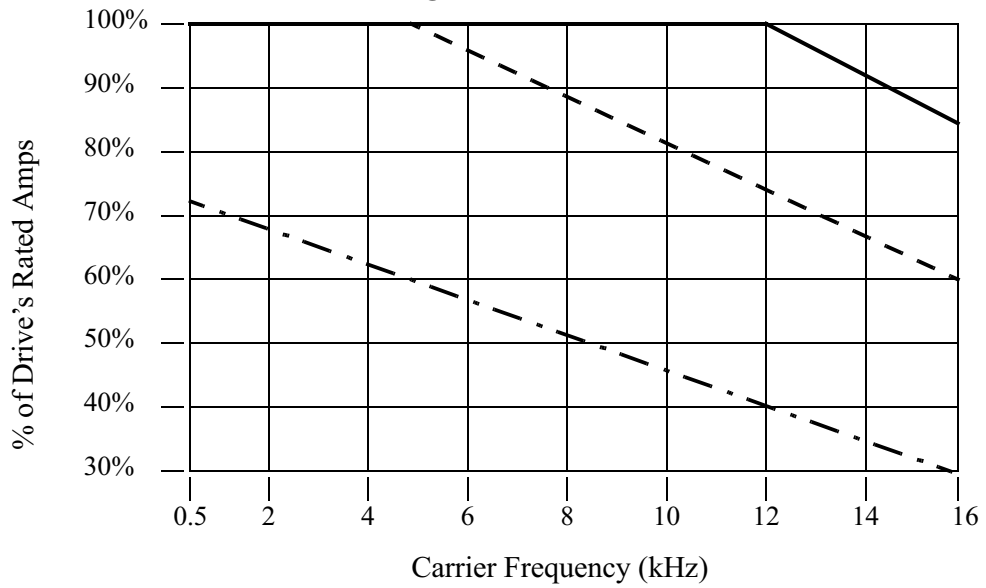

Catalog Number AV91AG0 B007D

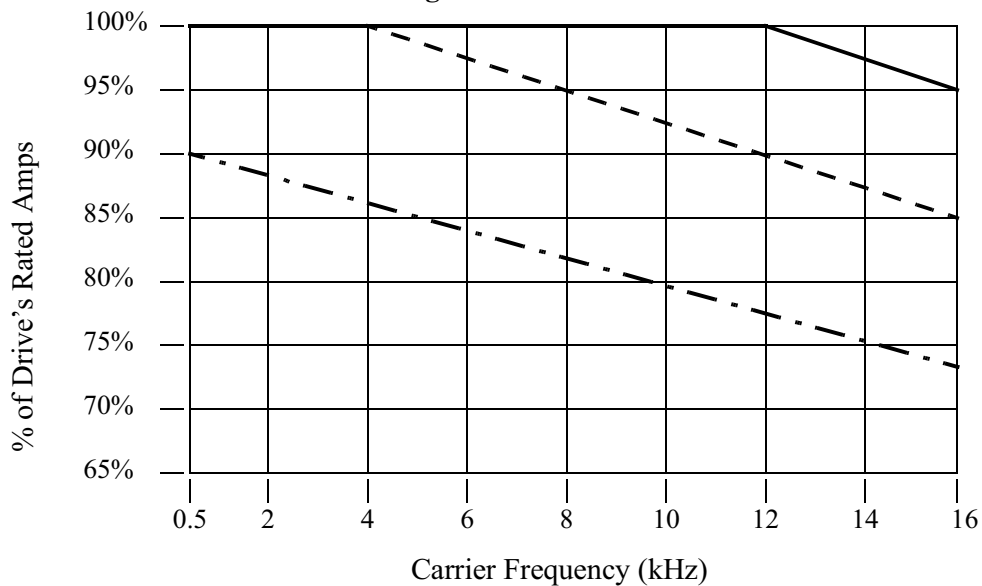

Catalog Number AV91AG0 B010D

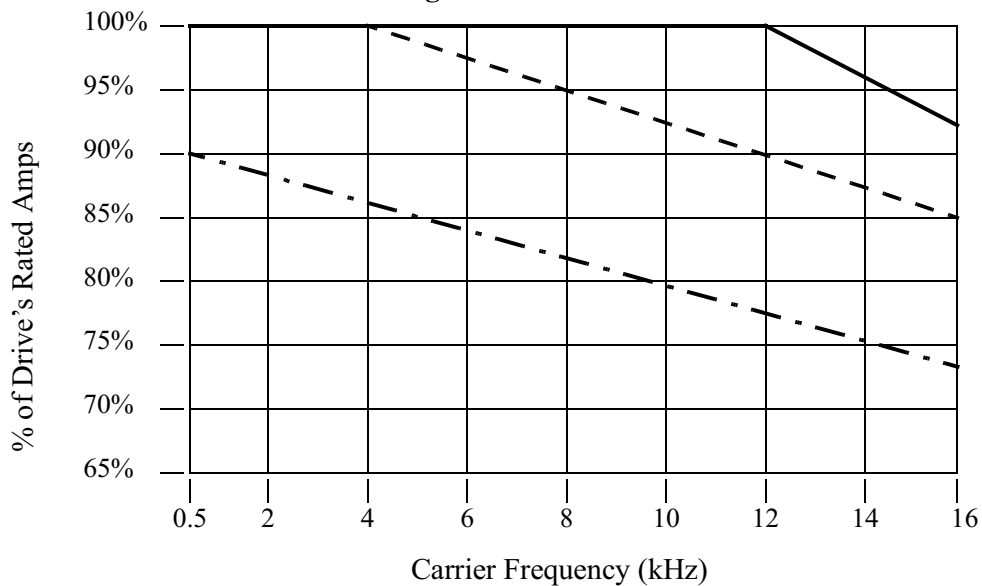

Catalog Number AV91AG0 C007D

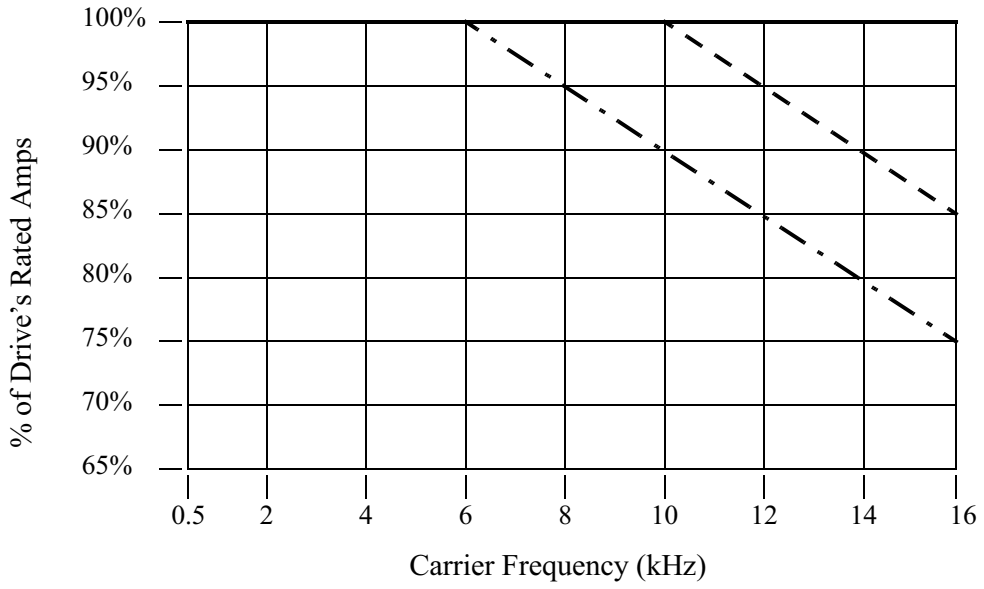

Catalog Number AV91AG0 C010D

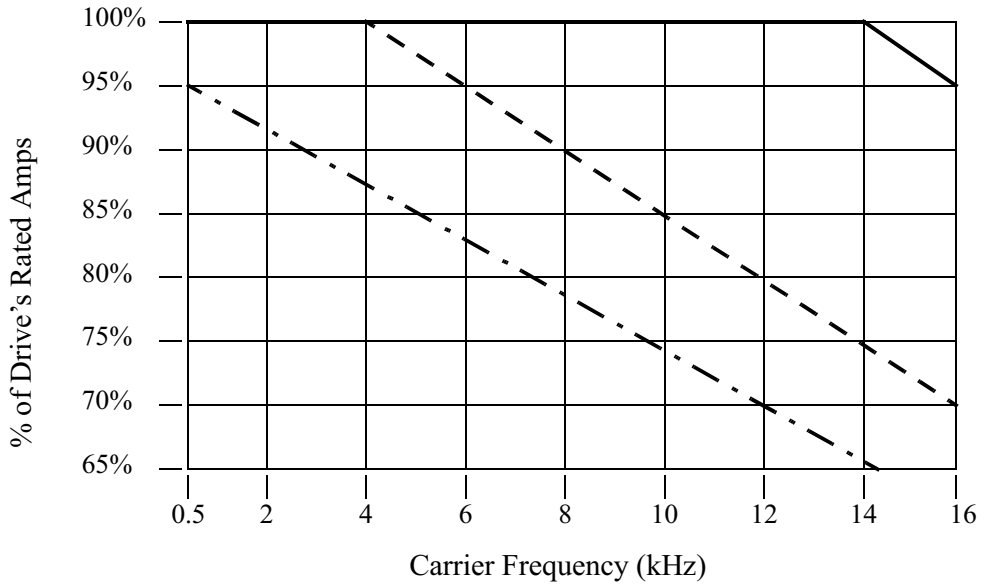

Introduction to Adjustable Frequency Drives

The Purpose of Motor Speed Control for Industry

Cutler-Hammer inverters provide speed control for 3-phase AC induction motors. You connect AC power to the inverter, and connect the inverter to the motor. You're probably familiar with the way a light dimmer works to vary the power sent to a light bulb, and thus the light intensity. At a basic level, the modern inverter serves the same role for a motor.

Many industrial applications use AC motors of all sizes to do many different things. In some cases, the motor connects directly to an AC power source — running at full speed whenever it is on. However, many applications benefit from a motor with variable speed, in several ways:

- Energy savings - HVAC
- Need to coordinate speed with an adjacent process - textiles and printing presses
- Sensitive loads - elevators, food processing, pharmaceuticals

Over the years, industry has found many ways to achieve variable speed when it benefited the process. Solutions varied from mechanical (belts and gears), hydraulic (pumps and motors), and electrical (two-speed motor windings, etc.) While these solutions provided some control over speed, there were unwanted side effects as well:

- Wasted energy from losses in speed-adjusting mechanisms (gearboxes, etc.)
- Wasted energy from on/off control trying to approximate an average
- Noise from belts and gears or start/stop operations
- Machinery with fluid leaks
- High maintenance and/or unreliable components
- Could set the speed, but acceleration and deceleration was still uncontrollable
- Not enough speed levels
- Poor torque performance at low speeds

Most of the unwanted side effects came from mechanical or hydraulic machinery, and could be solved with a purely electronic solution. But early electronic components had reliability shortcomings due to the large currents and high voltages imposed on the devices. However, the modern power components in use today have changed all that. The state-of-the-art components in Cutler-Hammer drives provide all the benefits of speed control, while overcoming the classical problems listed above.

What is an Inverter?

The terms *inverter* and *variable-frequency drive* and *adjustable-frequency drive* are related and somewhat interchangeable. An electronic motor drive for an AC motor can control the motor's speed by *varying the frequency* of the power sent to the motor. For example, a particular motor may be designed for 60 Hz operation. We say it is a *synchronous* motor if its speed of revolution is directly related to its power input frequency. When the motor design is synchronous, an adjustable frequency drive is able to control the speed by controlling the frequency.

An inverter, in general, is a device that converts DC power to AC power. The popular consumer power inverter is designed for powering an AC appliance from a car battery; put 12VDC in, and get 115VAC 50/60 Hz out, for example. The figure below shows how the adjustable frequency drive employs an internal inverter. The drive first converts incoming AC power to DC through a rectifier circuit, creating a high-voltage internal DC bus. Then the inverter circuit inverts the DC back to AC again to power the motor. However, this special inverter varies its output frequency and voltage according to the desired motor speed.

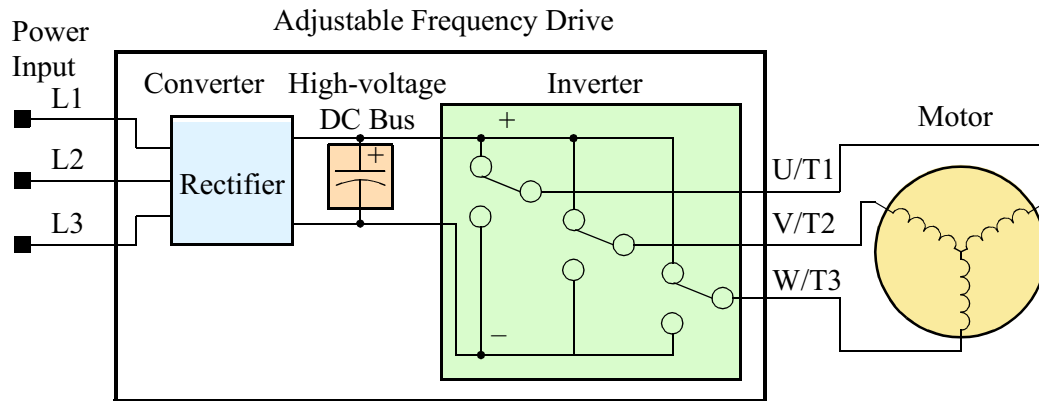

The simplified drawing of the inverter shows three double-throw switches. Usually implemented with six power transistors, outputs U/T1, V/T2, and W/T3 may switch positively or negatively. Using a commutation algorithm, the microprocessor in the drive switches the power transistors on and off at a very high speed to create the desired output waveforms. The reactance of the motor windings helps smooth out the pulses.

Torque and Constant Volts/Hertz Operation

In working with industrial motors we often discuss the motor *torque*. That is simply the rotational force the motor exerts at any given time. Though the goal of the inverter and associated control system is to control motor speed, the AF91sv inverter applies direct control to the output voltage, frequency, and current (to create a torque vector). Speed is achieved as a function of the applied torque value and its duration, and the load which the motor must move. If the inverter can create strong motor torque over most or all of the speed range, then it is relatively easy for the system to achieve any desired speed. *Speed regulation* is a measure of the accuracy speed control, given as a percent difference from a fixed value. In sensorless vector mode, the AF91sv delivers speed regulation (no load to full load) within 1% of the (full scale) motor nameplate speed value.

When varying the output frequency, the inverter drive also must vary the output voltage in proportion to the frequency. It does so because of the motor's characteristic inductive reactance. If the drive maintains a constant volts-per-hertz ratio, the motor will have constant torque characteristics. Constant torque is desirable for most applications, because it transfers power to the load consistently across the entire speed range.

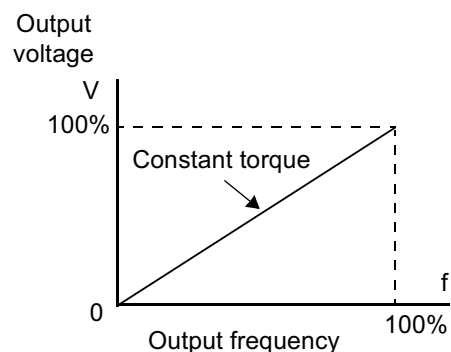

Inverter Input and Three-Phase Power

Heavy industrial machinery often needs the additional power available from higher voltage/current sources, and from three-phase power. The Cutler-Hammer AF91sv Series of inverters includes two sub-groups: the 200V class and the 400V class inverters. The drives described in this manual may be used in either the United States or Europe, although the exact voltage level for commercial power may be slightly different from country to country. Accordingly, a 200V class inverter requires (nominal) 200 to 240VAC, and a 400V class inverter requires from 380 to 460VAC. Some 200V class inverters will accept single-phase or three-phase power, but all 400V class inverters require a three-phase power supply.

The common terminology for single phase power is Line (L) and Neutral (N). Three-phase power connections are usually labeled Line 1 (L1), Line 2 (L2) and Line 2 (L3). In any case, the power source should include a ground connection. That ground connection will need to connect to the inverter chassis and to the motor frame (description given on page 2-16).

Inverter Output to the Motor

The AC motors also use three-phase power, but they must connect only to the inverter's output terminals. The output terminals are uniquely labeled (to differentiate them from the input terminals) with the designations U/T1, V/T2, and W/T3. This corresponds to typical motor lead connection designations T1, T2, and T3. It is generally not critical to connect a particular inverter output to a particular motor lead for a new application. The consequence of swapping any two of the three connections is the reversal of the motor direction. For safety reasons, you must connect the motor chassis ground to the ground connection at the bottom of the inverter housing.

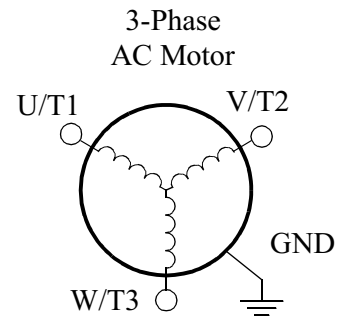

Notice the three connections to the motor do not include one marked “Neutral” or “Return.” The motor represents a balanced “Y” impedance to the inverter, so there is no need for a separate return. In other words, each of the three “Hot” connections serves also as a return for the other connections, because of their phase relationship.

The Cutler-Hammer inverter is a rugged and reliable device. The intention is for the inverter to assume the role of switching power to the motor during all normal operations. Therefore, this manual instructs you not to switch off power to the inverter *while the motor is running* (unless it is an emergency stop). Also, do not install or use disconnect switches in the wiring from the inverter to the motor (except thermal cut-off). Of course, safety-related devices such as fuses must be in the design to break power during a malfunction.

Intelligent Functions and Parameters

Much of this manual is devoted to describing how to use inverter functions and how to configure inverter parameters. The inverter is microprocessor-controlled, and has many independent functions. The microprocessor has an on-board EEPROM for parameter storage. The inverter's front panel keypad provides access to all functions and parameters, which you can access through other devices as well. The general name for all these devices is the *digital operator*, or *digital operator panel*. Chapter 2 will show you how to get a motor running, using a minimal set of function commands or configuring parameters.



The optional read/write programmer will let you read and write inverter EEPROM contents from the programmer. This feature is particularly useful for OEMs who need to duplicate a particular inverter's settings in many other inverters in assembly-line fashion.

Braking

In general, braking is a force that attempts to slow or stop motor rotation. So it is associated with motor deceleration, but may also occur even when the load attempts to drive the motor faster than the desired speed. If you need the motor and load to decelerate quicker than their natural deceleration during coasting, we recommend installing a braking resistor. The dynamic braking unit (built into the AF91sv) sends excess motor energy into the resistor to slow the motor and load (see pages 5-2 and 5-5 for more information). If you have a load that tries to drive the motor continuously for some period of time, that will require a different type of inverter with continuous regenerative capability. As an example, elevator control usually requires fast acceleration and deceleration profiles, so you may need to add a braking resistor. However, an application such as running an HVAC fan may just coast to a stop in most cases.

The inverter parameters include acceleration and deceleration, which you can program to match the needs of the application. For a particular inverter, motor, and load, there will be a range of practically achievable accelerations and decelerations.

Velocity Profiles

The AF91sv inverter is capable of sophisticated speed control. A graphical representation of that capability will help you understand and program the associated parameters. This manual makes use of the velocity profile graph used in industry (shown at right). In the example, the acceleration is a ramp to a set speed, and the deceleration is a decline to a stop.

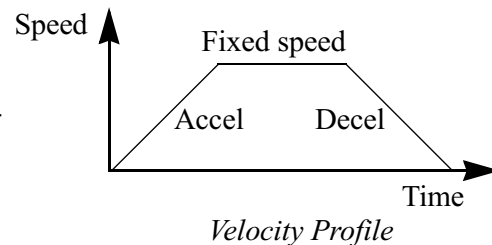

The AF91sv inverter can store up to 16 preset speeds. And, it can apply separate acceleration and deceleration transitions from any preset to any other preset speed. For example, a motor with a small load could use high accel/decel values, but a heavy load will generally use slower speed changes. A multi-speed profile (shown at right) uses two or more preset

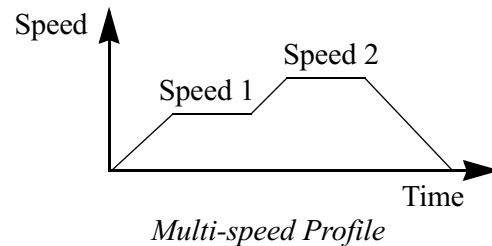

speeds in one motion of the load. There is no limit to the number of speed changes for one motion; that is up to the control input to the inverter. Also note that speed can be infinitely variable across the speed range. You can use the potentiometer control on the keypad for manual control. The drive also accepts analog 0-10V signals and 4-20 mA control signals as well.

The inverter can drive the motor in either direction. Separate FWD and REV commands select the direction of rotation. The motion profile example shows a forward motion followed by a reverse motion of shorter duration. The speed presets and analog signals control the magnitude of the speed, while the FWD and REV commands determine the direction before the motion starts.

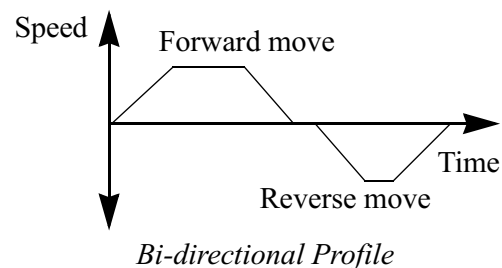

NOTE: The AF91sv can move loads in both directions. However, it is not designed for use in servo-type applications that use a bipolar velocity signal which determines direction.

Frequently Asked Questions

- Q.** What is the main advantage in using an inverter to drive a motor, compared to alternative solutions?
- A.** An inverter can vary the motor speed with very little loss of efficiency, unlike mechanical or hydraulic speed control solutions. The resulting energy savings usually pays for the inverter in a relatively short time.
- Q.** The term “inverter” is a little confusing, since we also use “drive” and “amplifier” to describe the electronic unit that controls a motor. What does “inverter” mean?
- A.** The terms *inverter*, *drive*, and *amplifier* are used somewhat interchangeably in industry. But there are subtle differences. A *drive* can refer to the motor, the control electronics, or both. This term is used particularly when the motor and electronics are integrated in the same housing. The term *variable speed drive* can include many types of devices – anything that has a variable speed output, which includes the Cutler-Hammer inverter. *Amplifier* more commonly refers to a linear amplifier for servo motor control, or a stepper motor driver IC. Finally, we use *inverter* to describe the Cutler-Hammer motor controller because of the way the switching electronics alternately *inverts* or *directly* couples its internal DC voltage bus to generate a variable AC output.
- Q.** Although the AF91sv inverter is a variable speed drive, can I use it in a fixed-speed application?
- A.** A fixed speed application usually is a result of cost-sensitivity or negligible benefits if variable speed were used (consumer products are examples). In those cases, the power source connects directly to the motor (no special drive needed). However, using a variable speed drive can benefit many type of industrial and commercial motor applications, by providing controlled acceleration and deceleration, high torque at low speeds, and energy savings over alternative solutions.
- Q.** Can I use an inverter and AC induction motor in a positioning application?
- A.** That depends on the required precision, and the slowest speed the motor will must turn and still deliver torque. The AF91sv inverter will deliver full torque while turning the motor at only 0.5 Hz (15 RPM). DO NOT use an inverter if you need the motor to stop and hold the load position without the aid of a mechanical brake (use a servo or stepper motion control system).
- Q.** Does the optional digital operator interface provide features beyond what is available from the keypad on the unit?
- A.** Yes. However, note first that the same set of parameters and functions are equally accessible from either the unit’s keypad or from remote devices. The Copy Unit lets you upload parameters from one inverter and download them into another inverter.

- Q.** Why does the manual or other documentation use terminology such as “200V class” instead of naming the actual voltage, such as “230 VAC?”
- A.** A specific inverter model is set at the factory to work across a voltage range particular to the destination country for that model. The model specifications are on the label on the side of the inverter. A European 200V class inverter (“EU” marking) has different parameter settings than a USA 200V class inverter (“US” marking). The initialization procedure (see page 6–8) can set up the inverter for European or US commercial voltage ranges.
- Q.** Why is there not a 100V class version of the AF91sv inverter, so it would work with a USA 115VAC power source, for example?
- A.** Most industrial, commercial, or heavy appliance applications use 230VAC in the USA. Also, a built-in advantage is that using the higher voltage means less current to deliver the same amount of power. This allows you to use smaller diameter (and less expensive) wire for power and motor wiring.
- Q.** I live in a country where the domestic utility power is 115 VAC. Is there a way to conveniently access a 230 VAC power source for a test bench to develop a motor application?
- A.** A 1:2 step-up transformer is available from a number of sources (check your local electrical supply house). The transformer will be designed to develop 230 VAC from 115 VAC, for example. Be sure the power output rating (kW) of the transformer is greater than 1.73 times the three-phase current of the motor you intend to power. We recommend doing this for motors 1/2 horsepower or smaller, with small loads. For 400 V class inverters, we recommend only using a utility power source of the correct voltage.
- Q.** Some models of Cutler-Hammer inverters will accept either single phase or three-phase power input. How do I know which input power type to use?
- A.** If three-phase power is conveniently available for your application, we recommend using that (the inverter can develop its three-phase output power most efficiently from three-phase input power). In the absence of three-phase power, you can use a single-phase power source with slightly less efficiency but the power output rating is the same for N models (single or three-phase).
- Q.** If I decide to use single-phase input power for the inverter, can I also use a single-phase motor?
- A.** No. All Cutler-Hammer inverters develop a variable three-phase output, requiring the use of a three-phase AC induction motor.
- Q.** Why doesn’t the motor have a neutral connection as a return to the inverter?
- A.** The motor theoretically represents a “balanced Y” load if all three stator windings have the same impedance. The Y connection allows each of the three wires to alternately serve as input or return on alternate half-cycles.
- Q.** Does the motor need a chassis ground connection?
- A.** Yes, for several reasons. This is for protection in the event of a short in the motor that puts a live voltage on its housing. Motors and other components

exhibit leakage currents that increase with aging. And, a grounded chassis generally emits less electrical noise than an ungrounded one.

- Q.** What type of motor is compatible with the Cutler-Hammer inverters?
- A.** **Motor type** – it must be a three phase AC induction motor. Use an inverter-grade motor that has 800V insulation for 200V class inverters, or 1600V insulation for 400V class.
- Motor size** – In practice, it's better to find the right size motor for your application; then look for the inverter to match the motor.
- Q.** How many poles should the motor have?
- A.** Using a four-pole motor will work for most applications. Cutler-Hammer inverters can be configured to operate motors with 2, 4, 6, or 8 poles. The greater the number of poles, the slower the top motor speed will be, but it will have higher torque at the slowest speed.
- Q.** Will I be able to add dynamic (resistive) braking to my Cutler-Hammer AF91sv drive after the initial installation?
- A.** Yes. The AF91sv inverter already has a dynamic braking circuit built in. Just add the resistor sized to meet the braking requirements.
- Q.** How will I know if my application will require resistive braking?
- A.** For new applications, it may be difficult to tell before you actually test a motor/drive solution. In general, some applications can rely on system losses such as friction to serve as the decelerating force, or otherwise can tolerate a long decel time. These applications will not need dynamic braking. However, applications with a combination of a high-inertia load and a required short decel time will need dynamic braking. This is a physics question that may be answered either empirically or through calculations.
- Q.** Several options related to electrical noise suppression are available for the Cutler-Hammer inverters. How can I know if my application will require any of these options?
- A.** The purpose of these noise filters is to reduce the inverter electrical noise so the operation of nearby electrical devices is not affected. Some applications are governed by particular regulatory agencies, and noise suppression is mandatory. In those cases, the inverter must have the corresponding noise filter installed. Other applications may not need noise suppression, unless you notice electrical interference with the operation of other devices.
- Q.** The AF91sv features a PID loop feature. PID loops are usually associated with chemical processes, heating, or process industries in general. How could the PID loop feature be useful in my application?
- A.** You will need to determine which main variable in your application the motor affects. That is the process variable (PV) for the motor. Over time, a faster motor speed will cause a faster change in the PV than a slow motor speed will. By using the PID loop feature, the inverter commands the motor to run at the optimal speed required to maintain the PV at the desired value for current conditions. Using the PID loop feature will require an additional sensor and other wiring, and is considered an advanced application.

Inverter Mounting and Installation



In This Chapter....	page
— Orientation to Inverter Features	2
— Basic System Description	6
— Step-by-Step Basic Installation	7
— Powerup Test	18
— Using the Front Panel Keypad	20

Orientation to Inverter Features

Unpacking and Inspection

Please take a few moments to unpack your new AF91sv inverter and perform these steps:

1. Look for any damage that may have occurred during shipping.
2. Verify the contents of the box include:
 - a. One AF91sv inverter
 - b. One Instruction Manual with self-adhesive label for the inverter
 - c. One AF91sv Quick-reference Guide
 - d. One packet of desiccant — discard (not for human consumption)
3. Inspect the specifications label on the side of the inverter. Make sure it matches the product part number you ordered.

Main Physical Features

The AF91sv Series inverters vary in size according to the current output rating and motor size for each model number. All feature the same basic keypad and connector interface for consistent ease of use. The inverter construction has a heat sink at the back of the housing. The larger models include a fan(s) to enhance heat sink performance. The mounting holes are pre-drilled in the heat sink for your convenience. Never touch the heat sink during or just after operation; it can be very hot.

The electronics housing and front panel are built onto the front of the heat sink. The front panel has three levels of physical access designed for convenience and safety:

- **First-level access** – for basic use of inverter during powered operation (power is On)
- **Second-level access** – for editing parameters and wiring control signals (power is On)
- **Third-level access** – for wiring the inverter power supply or motor (power is OFF)

1. **First-level Access** - View the unit just as it came from the box as shown. The four-digit display can show a variety of performance parameters. LEDs indicate whether the display units are Hertz or Amperes. Other LEDs indicate Power (external), and Run/Stop Mode and Program/Monitor Mode status. Membrane keys Run and Stop/Reset, and a Min/Max frequency control knob control motor operation. These controls and indicators are usually the only ones needed after the inverter installation is complete. You can also access the modular jack for connecting a programming or monitoring device such as a PC (see Chapter 3). And,



you can access the two chassis GND screws on the metal tab at the bottom of the inverter.

2. **Second-level access** - Locate the lift tab at the right lower corner of the front panel near the safety warning message. Lift the corner to swing the half-door around to the left. This exposes four more control buttons and some connectors. The Setup, Up, Down, and Enter keys allow an operator to access and change the inverter's functions and parameter values. The two 8-position connectors provide the interface for logic-level control signals. These signals are generally low-voltage in nature and are appropriate for second-level access.

Inverter Mounting and Installation



3. **Third-level access** - First, ensure no power source of any kind is connected to the inverter. If power has been connected, wait five minutes after powerdown and verify the Power LED is off to proceed. Then locate the recessed retention screw on the left side main front panel (it is along the left hinge area on some models, or behind the first access door on others). Use a small screwdriver (Regular or Phillips) to loosen the screw. Swing the door around to the left to reveal the internal components of the drive. The two-level tiered 12-position terminal block accepts wires for the power input and wires to the motor.

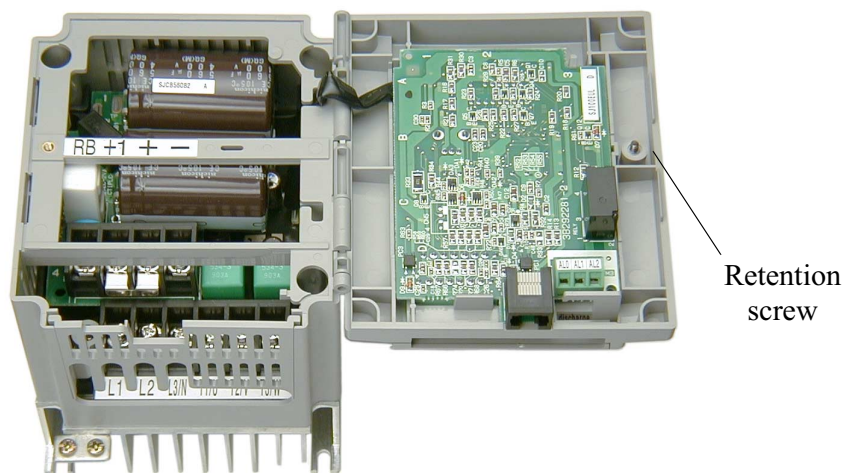

Notice the housing partition that lifts out to allow full access to the terminals for wiring as shown. Never operate the inverter drive with the partition removed or the full access door opened.

The alarm circuit connections are accessible on the 3-position connector near the modular connector on the rear of the main panel door. The nearby relay provides both normally-open and normally-closed logic for interface to an external alarm. The alarm circuit may carry hazardous live voltages even when the main power to the inverter is off. So, never directly touch any component on the circuit board in the panel door. A notch in the removable partition serves as the exit path for alarm circuit wiring.

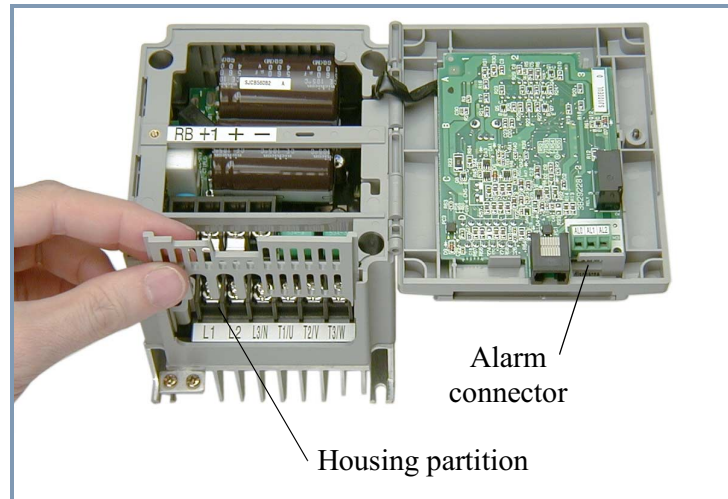

The following sections will describe the system design and guide you through a step-by-step installation process. After the section on wiring, this chapter will show how to use the front panel keys to access functions and edit parameters.

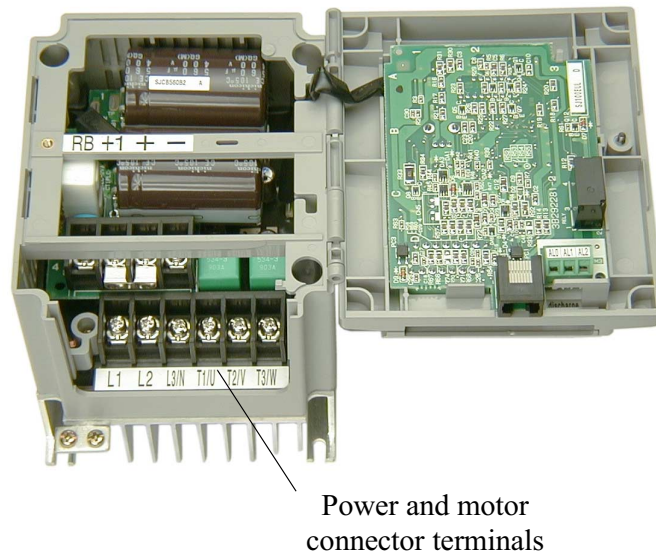

Basic System Description

A motor control system will obviously include a motor and inverter, as well as fuses for safety. If you are connecting a motor to the inverter on a test bench just to get started, that's all you may need for now. But a system can also have a variety of additional components. Some can be for noise suppression, while others may enhance the inverter's braking performance. The figure and table below show a system with all the optional components you may need in your finished application.

Inverter Mounting and Installation

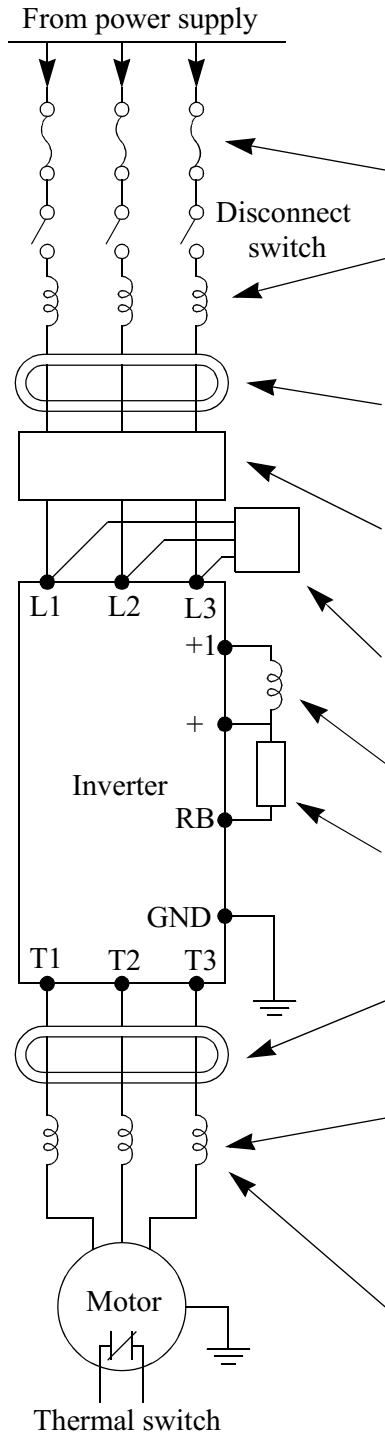

Name	Function
Fuse	Current overload protection for power supply and wiring.
Input-side AC Reactor	This is useful in suppressing harmonics induced on the power supply lines, or when the main power voltage imbalance exceeds 3% (and power source capacity is more than 500 kVA), or to smooth out line fluctuations. It also improves the power factor.
Radio noise filter	Electrical noise interference may occur on nearby equipment such as a radio receiver. This magnetic choke filter helps reduce radiated noise (can also be used on output).
EMI filter (for CE applications)	Reduces the conducted noise on the power supply wiring generated by the main power supply to protect the inverter. Connect to the inverter primary (input side).
Radio noise filter (use in non-CE applications)	This capacitive filter reduces radiated noise from the main power wires in the inverter input side.
DC link choke	Suppresses harmonics generated by the inverter. However, it will not protect the input diodes.
Braking resistor	This is useful for increasing the inverter's control torque for high duty-cycle (on-off) applications, and improving the decelerating capability.
Radio noise filter	Electrical noise interference may occur on nearby equipment such as a radio receiver. This magnetic choke filter helps reduce radiated noise (can also be used on input).
AC reactor	This reactor reduces the vibrations in the motor caused by the inverter's switching waveforms, by smoothing the waveforms to approximate commercial power quality. It is also useful when wiring from the inverter to the motor is more than 10m in length, to reduce harmonics.
LCR filter	Sine wave shaping filter for output side.

Note that some components are required for regulatory agency compliance (see Chapter 5).

Step-by-Step Basic Installation

This section will guide you through the following basic steps of installation:

1. Study the warnings associated with mounting the inverter.
2. Select a suitable mounting location.
3. Place covers over the inverter's ventilation openings to prevent debris from entering.
4. Check the inverter mounting dimensions for footprint and mounting hole locations.
5. Study the caution and warning messages associated with wiring the inverter.
6. Connect wiring for the inverter power input.
7. Connect wiring to the motor.
8. Remove any covers applied in Step 3 from the inverter's ventilation openings.
9. Perform a powerup test.
10. Make observations and check your installation.

Choosing a Mounting Location



Step 1: Study the following caution messages associated with mounting the inverter.

This is the time when mistakes are most likely to occur that will result in expensive rework, equipment damage, or personal injury.



CAUTION: Be sure to install the unit on flame-resistant material such as a steel plate. Otherwise, there is the danger of fire.



CAUTION: Be sure not to place any flammable materials near the inverter. Otherwise, there is the danger of fire.



CAUTION: Be sure not to let the foreign matter enter vent openings in the inverter housing, such as wire clippings, spatter from welding, metal shavings, dust, etc. Otherwise, there is the danger of fire.



CAUTION: Be sure to install the inverter in a place which can bear the weight according to the specifications in the text (Chapter 1, Specifications Tables). Otherwise, it may fall and cause injury to personnel.



CAUTION: Be sure to install the unit on a perpendicular wall which is not subject to vibration. Otherwise, it may fall and cause injury to personnel.



CAUTION: Be sure not to install or operate an inverter which is damaged or has missing parts. Otherwise, it may cause injury to personnel.



CAUTION: Be sure to install the inverter in a well-ventilated room which does not have direct exposure to sunlight, a tendency for high temperature, high humidity or dew condensation, high levels of dust, corrosive gas, explosive gas, inflammable gas, grinding-fluid mist, salt damage, etc. Otherwise, there is the danger of fire.

2

Step 2: To summarize the caution messages — you will need to find a solid, non-flammable, vertical surface that is a relatively clean and dry environment. In order to ensure enough room for air circulation around the inverter to aid in cooling, maintain the specified clearance around the inverter specified in the diagram.

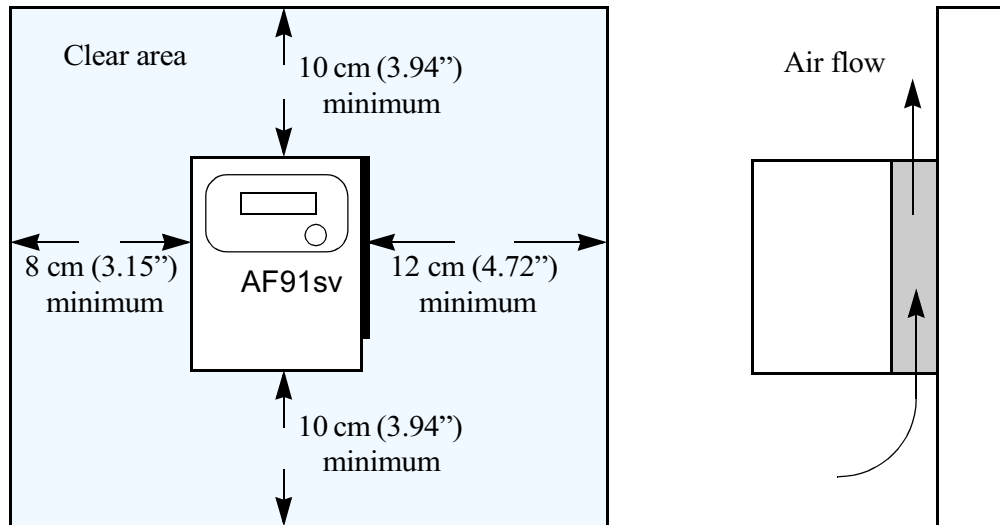

Inverter Mounting and Installation

3

Step 3: Before proceeding to the wiring section, it's a good time to *temporarily* cover the inverter's ventilation openings. Paper and masking tape is all that is needed to do this. It will prevent harmful debris such as wire clippings and metal shavings from entering the inverter during installation. The inverter housing comes from the factory with a snap-in cover on the top of its housing. Ensure it is in place at this time (also to be removed later, unless the installation must have a NEMA rating).

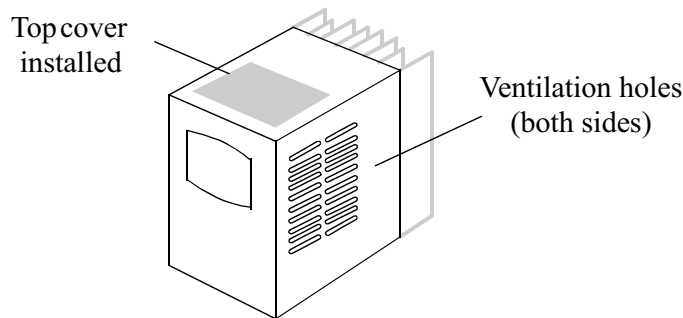

Please observe this checklist while mounting the inverter:

1. The ambient temperature must be in the range of -10 to 40°C. If the range will be up to 50°C, you will need to set the carrier frequency to 2.1 kHz or less and derate the output current to 80% or less. Chapter 3 covers how to change parameters such as the carrier frequency. **IMPORTANT:** Remember to remove the top cover (unless the installation is to have a NEMA rating)!
2. Keep any other heat-producing equipment as far away from the inverter as possible.
3. When installing the inverter in an enclosure, maintain the clearance around the inverter and verify that its ambient temperature is within specification when the enclosure door is closed.
4. Do not open the main front panel door at any time during operation.

Inverter Dimensions for Mounting

Step 4: Locate the applicable drawing on the following pages for your inverter.
4 Dimensions are given in millimeters (inches) format.

External Dimensions

MODEL	H mm (in.)
AV91AG0 BF25D	93 (3.66)
BF50D	107 (4.21)

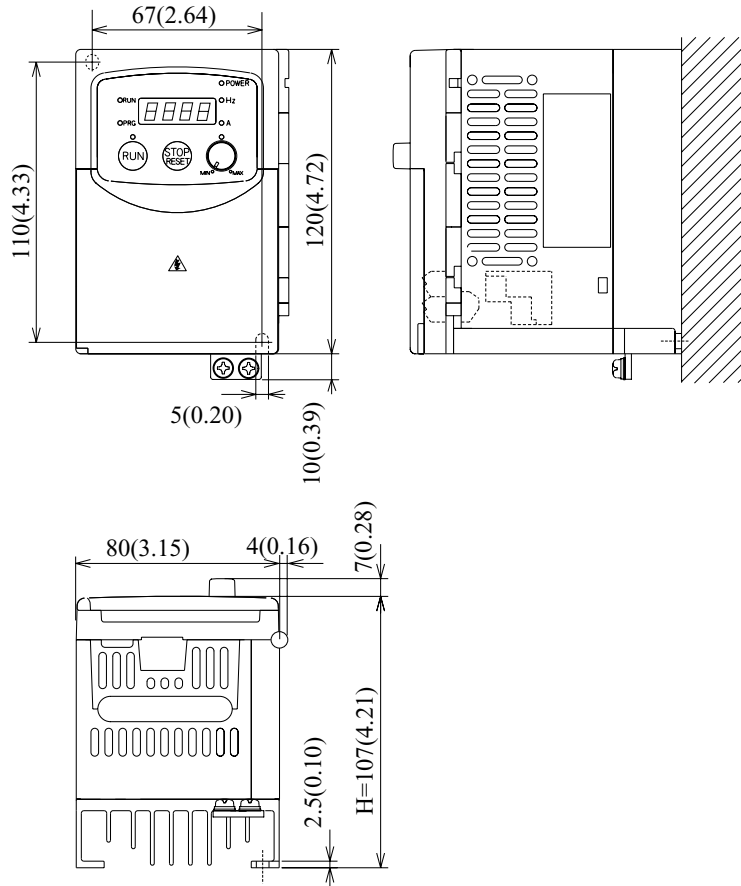

Inverter Mounting and Installation



NOTE: Some inverter housings require two mounting screws, while others require four. Be sure to use lock washers or other means to ensure screws do not loosen due to vibration.

Dimensional drawings continued...

External Dimensions

MODEL

AV91AG0 CF50D
B001D

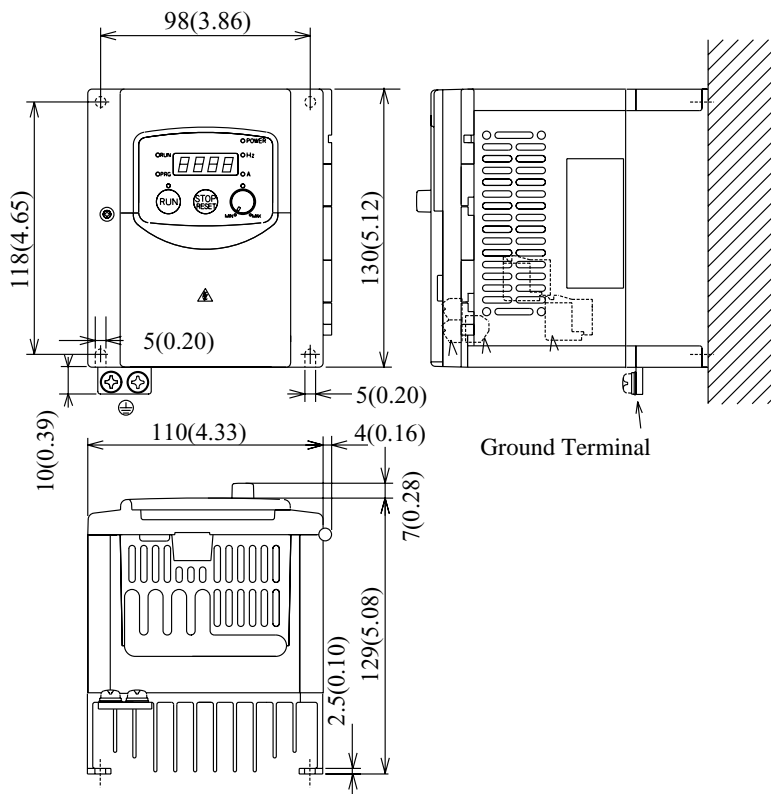

MODEL

AV91AG0 C001D (No fan)
C003D
C002D

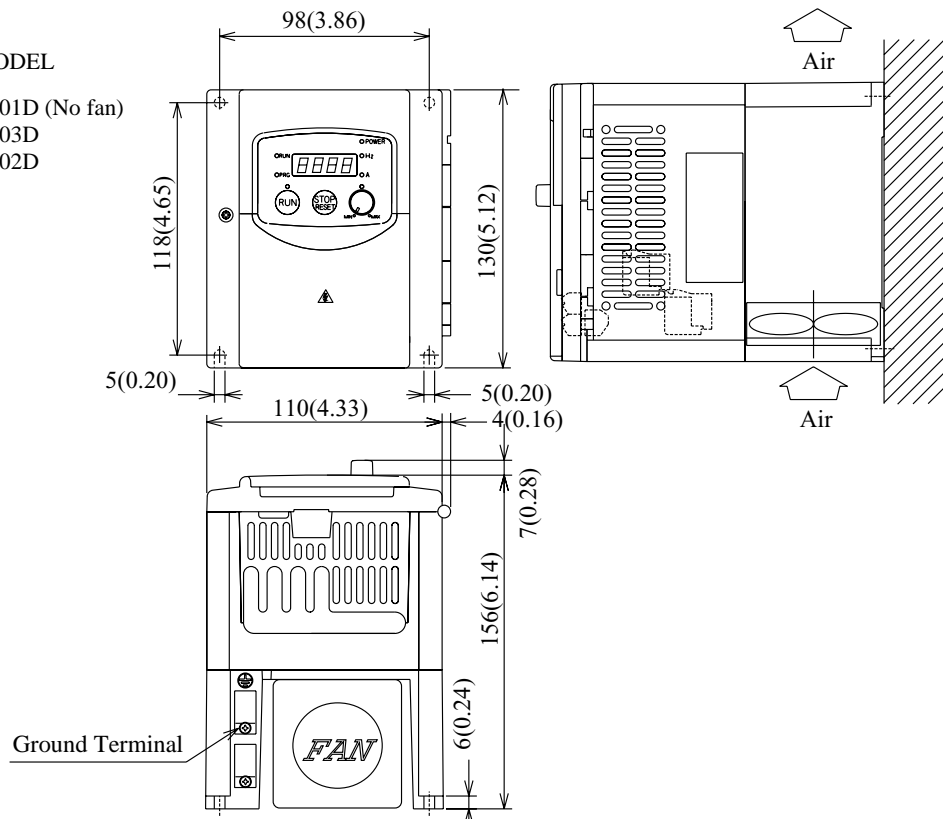

Dimensional drawings continued...

AV91AG0 B002D

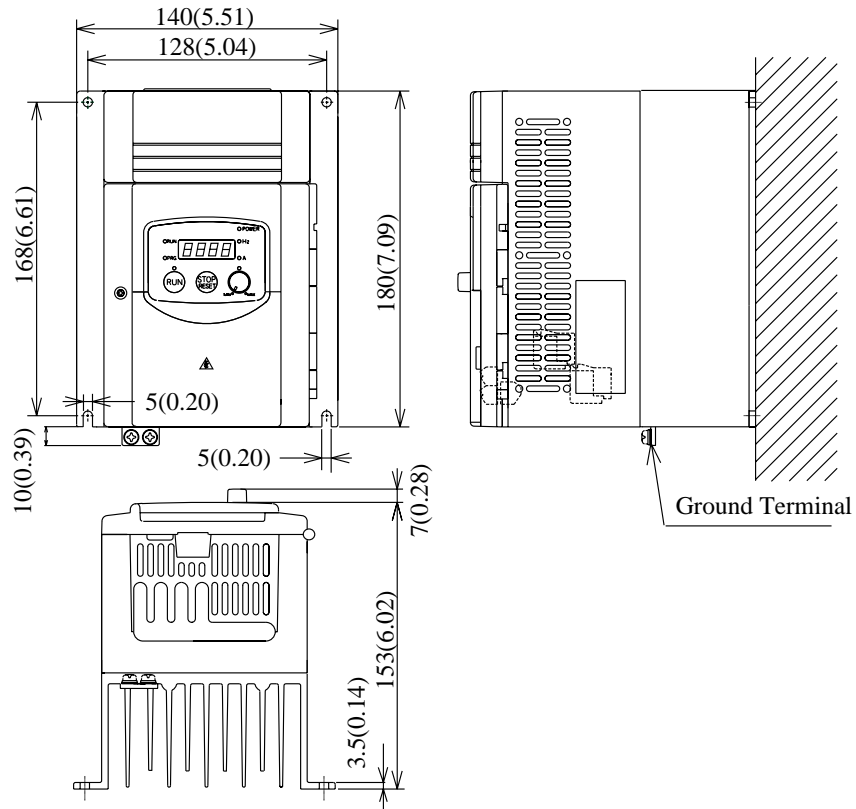

AV91AG0 B003D
B005D
C005D

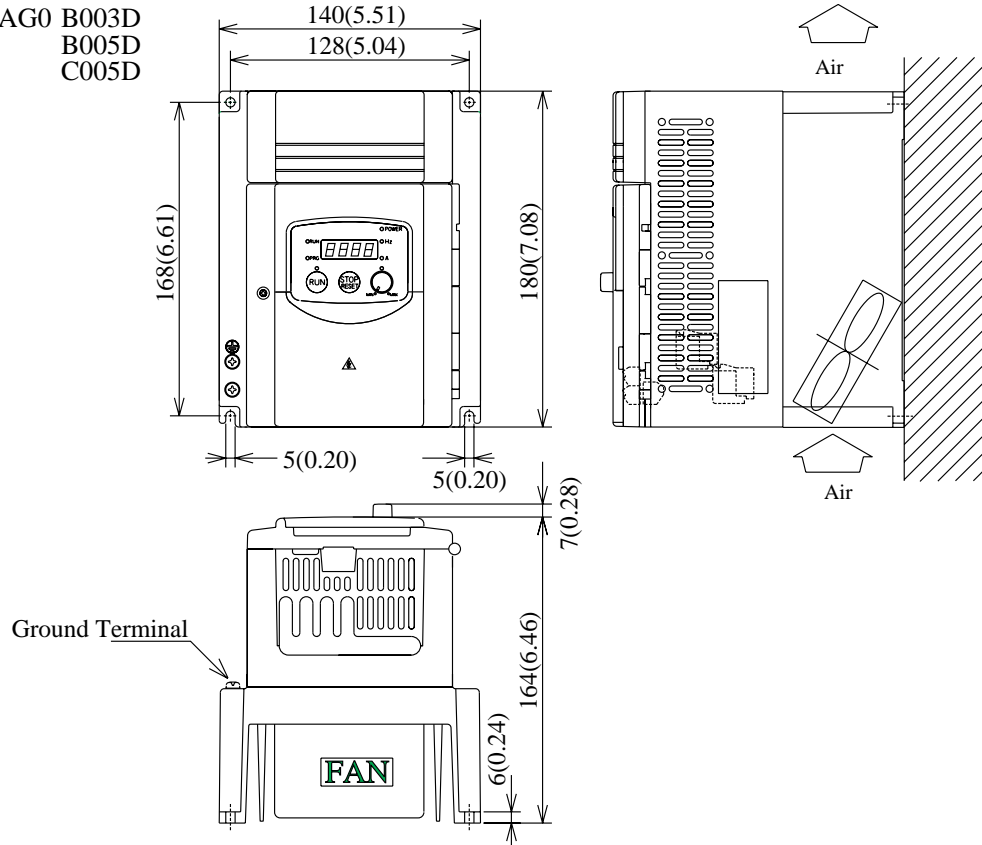

Inverter Mounting and Installation

Dimensional drawings continued...

AV91AG0 B007D
 B010D
 C007D
 C010D

Inverter Mounting and Installation

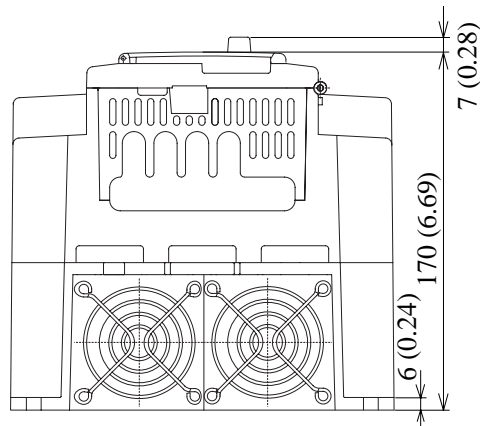
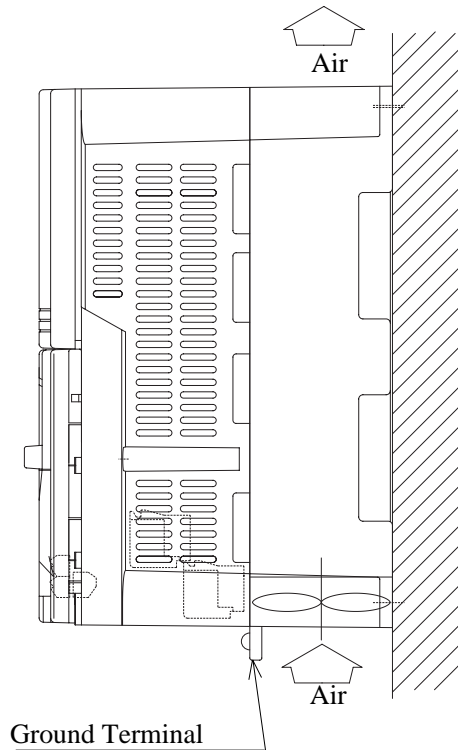
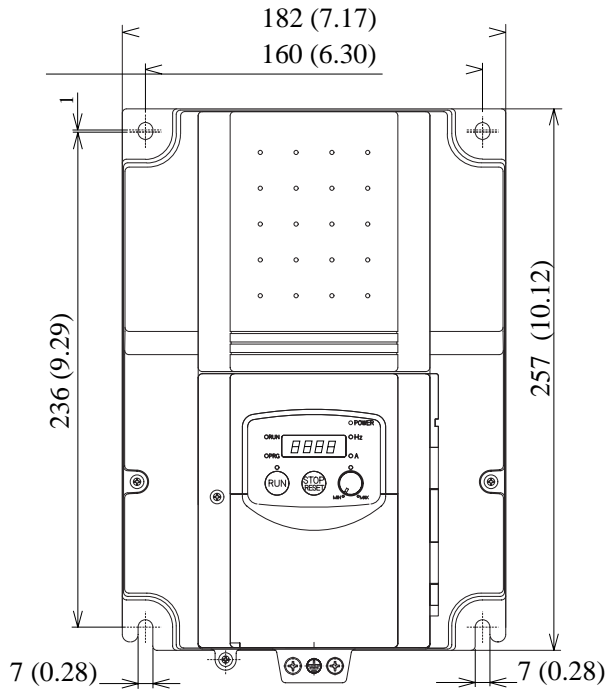

NOTE: Model AV91AG0 B007D has (2) fans. All other models in this housing have (1) fan.

Preparation for Wiring

5

Step 5: It is very important to perform the wiring steps carefully and correctly. Before proceeding, please study the caution and warning messages below.



WARNING: “Use 60/75°C Cu wire only” or equivalent.



WARNING: “Open Type Equipment.”



WARNING: “A Class 2 circuit wired with Class 1 wire” or equivalent.



WARNING: “Suitable for use on a circuit capable of delivering not more than 5,000 rms symmetrical amperes, 240 V maximum.” For models with suffix B (example: BF25D).



WARNING: “Suitable for use on a circuit capable of delivering not more than 5,000 rms symmetrical amperes, 480 V maximum.” For models with suffix C (example: CF50D).



HIGH VOLTAGE: Be sure to ground the unit. Otherwise, there is a danger of electric shock and/or fire.



HIGH VOLTAGE: Wiring work shall be carried out only by qualified personnel. Otherwise, there is a danger of electric shock and/or fire.



HIGH VOLTAGE: Implement wiring after checking that the power supply is off. You may incur electric shock and/or fire.



HIGH VOLTAGE: Do not connect wiring to an inverter or operate an inverter that is not mounted according the instructions given in this manual. Otherwise, there is a danger of electric shock and/or injury to personnel.

Determination of Wire and Fuse Sizes

The maximum motor currents in your application determines the recommended wire size. The following table gives the wire size in AWG. The “Power Lines” column applies to the inverter input power, output wires to the motor, the ground connection, and any other component shown in the system wiring diagram on page 2-6. The “Signal Lines” column applies to any wire connecting to the two green 8-position connectors just inside the front panel half-door.

Motor Output (kW/HP)		Inverter Model	Wiring		Applicable equipment
kW	HP		Power Lines	Signal Lines	Fuse (class J) rated 600V
0.2	1/4	AV91AGO BF25D	AWG16 / 1.3 mm ²	(*) 18 to 28 AWG / 0.14 to 0.75 mm ² shielded wire	10A
0.4	1/2	AV91AGO BF50D			15A
.75	1	AV91AGO B001D	AWG14 / 2.1 mm ²		20A (single ph.) 15A (three ph.)
1.5	2	AV91AGO B002D	AWG12 / 3.3 mm ²		30A (single ph.) 20A (three ph.)
2.2	3	AV91AGO B003D	AWG10 / 5.3 mm ²		30A
3.7	5	AV91AGO B005D	AWG12 / 3.3 mm ²		40A
5.5	7 1/2	AV91AGO B007D	AWG10 / 5.3 mm ²		50A
7.5	10	AV91AGO B010D	AWG8 / 8.4 mm ²		3A
0.4	1/2	AV91AGO CF50D	AWG16 / 1.3 mm ²		6A
0.75	1	AV91AGO C001D			10A
1.5	2	AV91AGO C002D		15A	
2.2	3	AV91AGO C003D		20A	
4.0	5	AV91AGO C005D	AWG14 / 2.1 mm ²	25A	
5.5	7 1/2	AV91AGO C007D	AWG12 / 3.3 mm ²		
7.5	10	AV91AGO C010D			

Note 1: Field wiring must be made by a UL-listed and CSA-certified closed-loop terminal connector sized for the wire gauge involved. Connector must be fixed by using the crimping tool specified by the connector manufacturer.

Note 2: Be sure to consider the capacity of the circuit breaker to be used.

Note 3: Be sure to use larger wires for the power lines if the distance exceeds 20 meters.

(*) Use 18 AWG / 0.75 mm² wire for the alarm signal wire (AL0, AL1, AL2 terminals).

Wiring the Inverter Input to a Power Supply

6

Step 6: In this step, you will connect wiring to the input of the inverter. First, you must determine whether the inverter model you have requires three-phase power only, or if it can accept either single-phase or three-phase power. All models have the same power connector terminals labeled **L1, L2, and L3/N**. So, you **must refer to the specifications label (on the side of the inverter) for the acceptable power source types! For inverters which can accept single-phase power and are connected that way, terminal L2 will remain unconnected.** The wiring example to the right shows an AF91sv inverter wired for 3-phase input. Note the use of spade lug connectors for a secure connection.

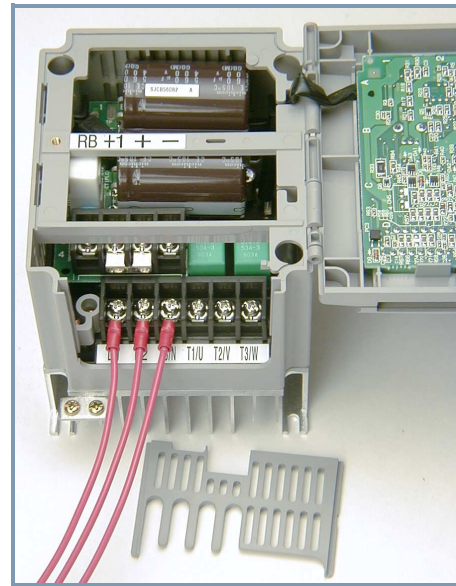

Inverter Mounting and Installation



NOTE: An inverter powered by a portable power generator may receive a distorted power waveform, overheating the generator. In general, the generator capacity should be five times that of the inverter (kVA) in a PWM (pulse-width modulated) control system, or six times greater in a PAM (pulse-amplitude modulated) control system.



CAUTION: Be sure that the input voltage matches the inverter specifications:

- Single/Three phase 200 to 240 V 50/60 Hz (up to 2.2kW)
- Three phase 200 to 230V 50/60Hz (above 2.2kW)
- Three phase 380 to 460 V 50/60Hz



CAUTION: Be sure not to input a single phase to a three-phase-only type inverter. Otherwise, there is the danger of fire.



CAUTION: Be sure not to connect an AC power supply to the output terminals. Otherwise, there is the danger of injury and/or fire.

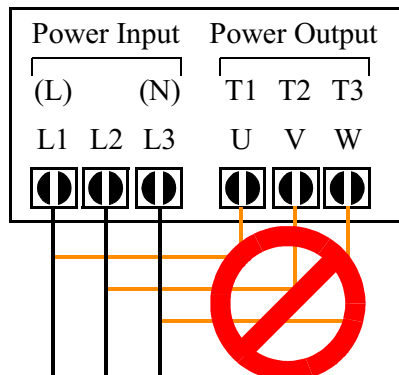

NOTE:

- L, N: Single-phase 200 to 240V 50/60 Hz
- L1, L2, L3: Three-phase 200 to 230V 50/60 Hz
- Three-phase 380 to 460V 50/60 Hz



CAUTION: Fasten the screws with the specified fastening torque (see the following table). Check for any loosening of screws. Otherwise, there is the danger of fire.



CAUTION: Remarks for using ground fault circuit breakers in the main power supply: Adjustable frequency drives with CE-filters (RFI-filter) and shielded (screened) motor cables have a higher leakage current toward GND. Especially at the moment of switching on this can cause inadvertent tripping of ground fault circuit breakers. Because of the rectifier on the input side of the inverter there is the possibility to stall the switch-off function through small amounts of DC current. Please observe the following:

- Use only short time-invariant and pulse current-sensitive ground fault circuit breakers with higher trigger current.
- Other components should be secured with separate ground fault circuit breakers.
- Ground fault circuit breakers in the power input wiring of an inverter are not an absolute protection against electric shock by direct touching.



CAUTION: Be sure to install a fuse in the wire for each phase of the main power supply to the inverter. Otherwise, there is the danger of fire.



CAUTION: For motor leads, ground fault breakers and electromagnetic contactors, be sure to size these components properly (each must have the capacity for rated current and voltage). Otherwise, there is the danger of fire.

Terminal Dimensions and Tightening Torque

The terminal screw dimensions for all AF91sv inverters are listed in table below. This information is useful in sizing spade lug or ring lug connectors for wire terminations.

Connector	Number of Screw Terminals	Models BF25D, BF50D		Models B001D–B003D, B005D, CF50D – C005D		Models B007D, B010D, C007D, C010D	
		Screw Diameter	Width (mm)	Screw Diameter	Width (mm)	Screw Diameter	Width (mm)
Power Terminals	12	M3.5	7.1	M4	9	M5	13
Control Signal	16	M2	–	M2	–	M2	–
Alarm Signal	3	M3	–	M3	–	M3	–
Ground Terminals	2	M4	–	M4	–	M5	–

When connecting wiring, use the tightening torque listed in the following table:

Screw	Tightening Torque	Screw	Tightening Torque	Screw	Tightening Torque
M2	0.2 N·m (0.25 max.) 0.15 ft-lbs (0.18 max.)	M3.5	0.8 N·m (0.9 max.) 0.59 ft-lbs (0.66 max.)	M5	2.0 N·m (2.2 max.) 1.48 ft-lbs (1.62 max.)
M3	0.5 N·m (0.6 max.) 0.37 ft-lbs (0.44 max.)	M4	1.2 N·m (max. 1.3 N·m) 0.89 ft-lbs (0.96 max.)	—	—

Wiring the Motor to the Inverter Output

7

Step 7: The process of motor selection is beyond the scope of this manual. However, it must be an AC induction motor with three phases. It should also come with a chassis ground lug. If the motor does not have three power input leads, stop the installation and verify the motor type. Other guidelines for wiring the motor include:

- Use an inverter-grade motor for maximum motor life (1600V insulation).
- For standard motors, use the AC reactor accessory if the wiring between the inverter and motor exceeds 30 feet (10 meters) in length.

Simply connect the motor to the terminals indicated on the inverter to the right. The terminals are labeled U/T1, V/T2, and W/T3. This is a good time to connect the chassis ground lug on the drive as well. The motor chassis ground must also connect to the same point. Use a star ground (single-point) arrangement, and never daisy-chain the grounds (point-to-point).

Use the same wire gauge on the motor and chassis ground wiring as you used on the power input wiring in the previous step. After completing the wiring:

- Replace the housing partition that covers access to the power connections.
- Close the main door and secure the retention screw firmly.

Other Wiring - After the initial installation and powerup test, you may need to wire the remaining connectors — the control signal connector, and the alarm circuit connector. This is covered in detail on page 4-25.

8

Step 8: After mounting and wiring the inverter, it's time to remove any covers from the inverter housing. This includes covers over the side ventilation ports. Remove the square cover panel at the top of the housing, unless the application must maintain a NEMA rating.



WARNING: Make sure the input power to the inverter is off. If the drive has been powered, leave it off for five minutes before continuing.

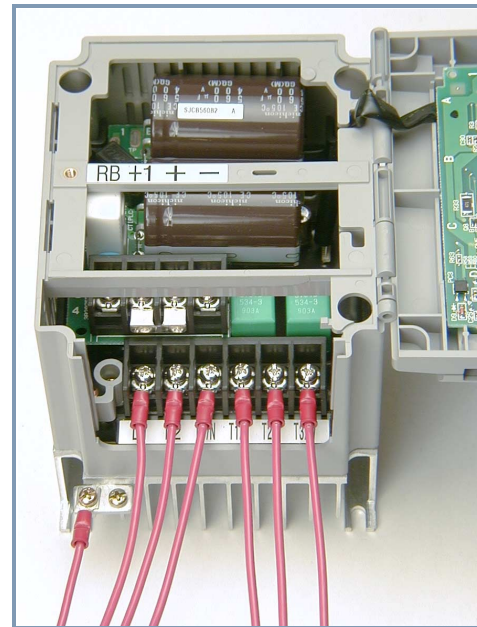

To Chassis Ground To Power Supply To Motor



The top housing cover is held in place by four locking tabs. To remove the cover, squeeze two corners together and push a small screwdriver under one side as shown, while pulling upward. Hold the screwdriver at the angle shown, and **DO NOT** push the screwdriver or any object through ventilation openings and into the inverter.

Powerup Test

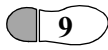

Step 9: After wiring the inverter and motor, you're ready to do a powerup test. The procedure that follows is designed for the first-time use of the drive. Please verify the following conditions before conducting the powerup test:

- You have followed all the steps in this chapter up to this step.
- The inverter is new, and is securely mounted to a non-flammable vertical surface
- The inverter is connected to a power source and motor.
- No additional wiring of inverter connectors or terminals has been done.
- The power supply is reliable, and the motor is a known working unit.
- The motor is securely mounted, and is not connected to any load.

Goals for the Powerup Test

If there are any exceptions to the above conditions at this step, please take a moment to take any measures necessary to reach this basic starting point. The specific goals of this powerup test are:

1. Verify that the wiring to the power supply and motor is correct.
2. Demonstrate that the inverter and motor are generally compatible.
3. Give a brief introduction to the use of the built-in operator keypad.

The powerup test gives you an important starting point to ensure a safe and successful application of the Cutler-Hammer inverter. We highly recommend performing this test before proceeding to the other chapters in this manual.

Pre-test and Operational Precautions

The following instructions apply to the powerup test, or to any time the inverter is powered and operating. Please study the following instructions and messages before proceeding with the powerup test.

1. The power supply must have fusing suitable for the load. Check the fuse size chart presented in Step 5, if necessary.
2. Be sure you have access to a disconnect switch for the drive input power if necessary. However, do not turn off power to the inverter during its operation unless it is an emergency.
3. Turn the inverter's front panel potentiometer to the *MIN* position (fully counter-clockwise).



CAUTION: The heat sink fins will have a high temperature. Be careful not to touch them. Otherwise, there is the danger of getting burned.



CAUTION: The operation of the inverter can be easily changed from low speed to high speed. Be sure check the capability and limitations of the motor and machine before operating the inverter. Otherwise, there is the danger of injury.



CAUTION: If you operate a motor at a frequency higher than the inverter standard default setting (50Hz/60Hz), be sure to check the motor and machine specifications with the respective manufacturer. Only operate the motor at elevated frequencies after getting their approval. Otherwise, there is the danger of equipment damage.



CAUTION: Check the following before and during the powerup test. Otherwise, there is the danger of equipment damage.

- Is the shorting bar between the +1 and + terminals installed? DO NOT power or operate the inverter if the jumper is removed.
 - Is the direction of the motor correct?
 - Did the inverter trip during acceleration or deceleration?
 - Were the rpm and frequency meter readings as expected?
 - Were there any abnormal motor vibrations or noise?
-

Powering the Inverter

If you have followed all the steps, cautions and warnings up to this point, you're ready to apply power. After doing so, the following events should occur:

- The *POWER* LED will illuminate.
- The numeric (7-segment) LEDs will display a test pattern, then stop at *0.0*.
- The *Hz* LED will be on.

If the motor starts running unexpectedly or any other problem occurs, press the *STOP* button. Only if necessary should you remove power to the inverter as a remedy.



NOTE: If the inverter has been previously powered and programmed, the LEDs (other than the *POWER* LED) may illuminate differently than as indicated above. If necessary, you can initialize all parameters to the factory default settings. See the initialization instructions on page 6-8.

Using the Front Panel Keypad

Front Panel Introduction

Please take a moment to familiarize yourself with the keypad layout shown in the figure below. These are the visible controls and indicators when the front panel door is closed.

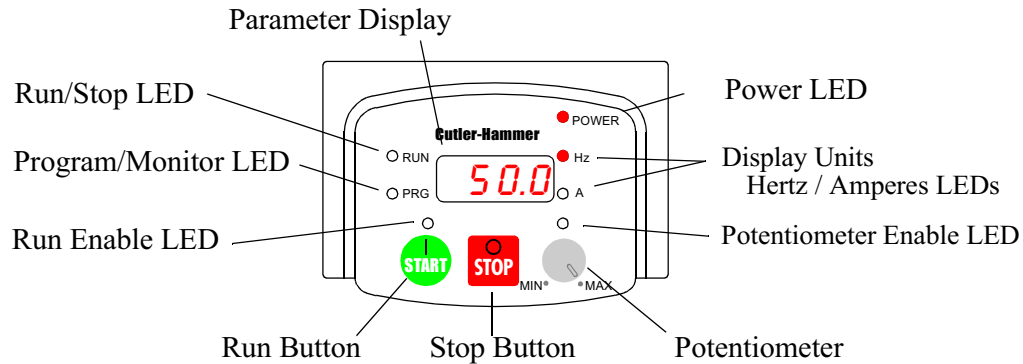

The display is used in programming the inverter's parameters, as well as monitoring specific parameter values during operation. Many functions are applicable only during the initial installation, while others are more useful for maintenance or monitoring.

Parameter Editing Controls

Now, open the front panel (half-door) for second-level access to reveal additional operator keys for parameter editing as shown below. In normal operation after installation, parameter editing is unnecessary, so these controls are hidden from view.

The front panel controls and indicators are described as follows:

- **Run/Stop LED** - On when the inverter output is running the motor (Run Mode), and Off when the inverter output is Off (Stop Mode).
- **Program/Monitor LED** - This LED is On when the inverter is ready for parameter editing (Program Mode). It is Off when the parameter display is monitoring data (Monitor Mode).
- **Run Enable LED** - is On when the inverter is ready to respond to the Run command, Off when the Run command is disabled.
- **Start Key** - Press this key to run the motor (the Run Enable LED must be ON first).
- **Stop Key** - Press this key to stop the motor when it is running (uses the programmed deceleration rate). This key will also reset an alarm which has tripped.
- **Potentiometer** - allows an operator to enter data for selecting a scalar value from a range, associated with the inverter output frequency.
- **Potentiometer Enable LED** - On when the potentiometer is enabled for value entry.
- **Parameter Display** - a 4-digit, 7-segment display for parameters and function codes.
- **Display Units, Hertz/Amperes** - One of these LEDs will be On to indicate the units associated with the parameter display.
- **Power LED** - This LED is On when the power input to the inverter is on.

- **Setup (SETUP) Key** - Use this key to navigate through the lists of parameters and functions for setting and monitoring parameter values.
- **Up/Down (UP, DOWN) Keys** - Use these keys alternately to move up or down the lists of parameter and functions shown in the display, and increment/decrement values.
- **Enter (ENTER) Key** - When the unit is in Program Mode and the operator has edited a parameter value, press the Store key to write the new value to the EEPROM.

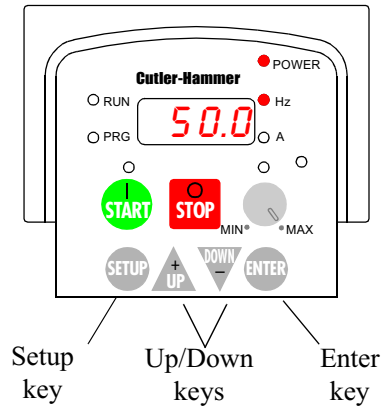

Inverter Mounting and Installation

Keys, Modes, and Parameters

Purpose of the keypad is to provide a way to change modes and parameters. The term *function* applies to both monitoring modes and parameters. These are all accessible through *function codes*, which are primarily 3-character codes. The various functions are separated into related groups identifiable by the left-most character, as the table shows.

Function Group	Type (Category) of Function	Mode to Access	PGM LED Indicator
“D”	Monitoring functions	Monitor	○
“F”	Basic profile parameters	Program	●
“A”	Standard functions	Program	●
“B”	Fine tuning functions	Program	●
“C”	Intelligent terminal functions	Program	●
“H”	Sensorless vector functions	Program	●
“E”	Error codes	—	—

For example, function “A 04” is the *base frequency setting* for the motor, typically 50 Hz or 60 Hz. To edit the parameter, the inverter must be in Program Mode (PGM LED will be On). You use the front panel keys to first select the function code “A 04.” After displaying the value for “A 04,” use the Up/Down (UP or DOWN) keys to edit the value.



NOTE: The inverter 7-segment display shows lower case “b” and “d”, which means the same as the upper case letters “B” and “D” used in this manual (for uniformity “A to F”).

The inverter automatically switches into Monitor Mode when you access “D” group functions. It switches into Program Mode when you access any other group, because they all have editable parameters. Error codes use the “E” group, and appear automatically when a fault event occurs. Refer to page 6-6 for error code details.

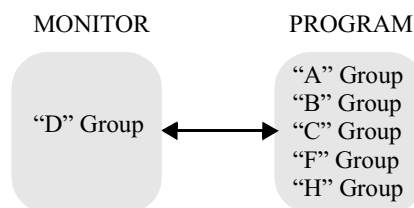

Keypad Navigational Map

The AF91sv Series inverter drives have many programmable functions and parameters. Chapter 3 will cover these in detail, but we need to access just a few items to perform the powerup test. The menu structure makes use of function codes and parameter codes to allow programming and monitoring with only a 4-digit display and a few buttons and LEDs. So, it is important to become familiar with the basic navigational map of parameters and functions in the diagram below. You may later use this map as a reference.

Inverter Mounting and Installation

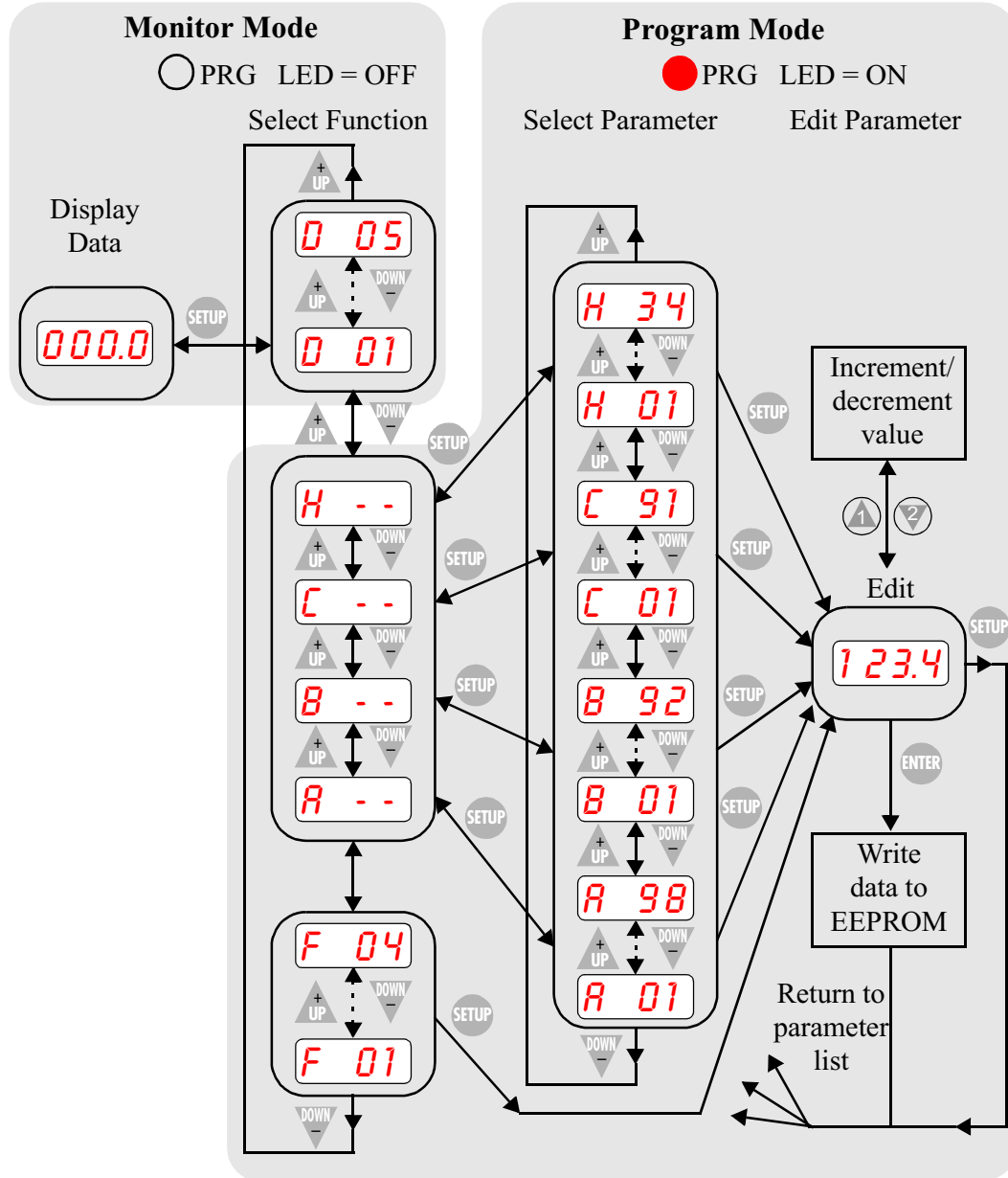

The navigational map shows the relationship of all resources of the inverter in one view. In general, use the **SETUP** key to move left and right, and the **UP** & **DOWN** (Up/Down) keys to move up and down. Other tables in this chapter will show how to set up a particular parameter, for example. However, the map above gives the “big picture” for functions in general.

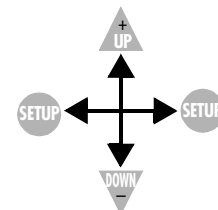

Selecting Functions and Editing Parameters

In order to run the motor for the powerup test, this section will show how to:

















- select the inverter's maximum output frequency to the motor
- select the keypad potentiometer as the source of motor speed command
- select the keypad as the source of the RUN command
- set the number of poles for the motor
- enable the RUN command

The following series of programming tables are designed for successive use. Each table uses the previous table's final state as the starting point. Therefore, start with the first and continue programming until the last one. If you get lost or concerned that some of the other parameters settings may be incorrect, refer to the section on restoring factory default settings on page 6–8.





CAUTION: If you operate a motor at a frequency higher than the inverter standard default setting (50Hz/60Hz), be sure to check the motor and machine specifications with the respective manufacturer. Only operate the motor at elevated frequencies after getting their approval. Otherwise, there is the danger of equipment damage.

Setting the Motor Base Frequency -The motor is designed to operate at a specific AC frequency. Most commercial motors are designed for 50/60 Hz operation. First, check the motor specifications. Then follow the steps in the table below to verify the setting or correct for your motor. DO NOT set it for greater than 50/60 Hz unless the motor manufacturer specifically approves operation at the higher frequency.

Action	Display	Func./Parameter
Press the  key.		Monitor functions
Press the  or  keys until ->		"A" group selected
Press the  key.		First "A" parameter
Press the  key twice.		Base frequency setting
Press the  key.	 or 	Default value for base frequency. US = 60 Hz, Europe = 50 Hz.
Press the  or  key as needed.		Set to your motor specs (your display may be different)
Press the  key.		Stores parameter, returns to "A" group list











TIP: If you need to scroll through a function or parameter list, press and hold the  or  key to auto-increment through the list.







Select the Potentiometer for Speed Command - the motor speed may be controlled from the following sources:

- Potentiometer on front panel keypad
- Control terminals
- Remote panel

Then follow the steps in the table below to select the potentiometer for the speed command (the table resumes action from the end of the previous table).

Action	Display	Func./Parameter
Press the  key twice.		Speed command source setting
Press the  key.		0 = potentiometer 1 = control terminals (default) 2 = keypad
Press the  key.		0 = potentiometer (selected)
Press the  key.		Stores parameter, returns to “A” group list

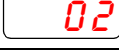
Select the Keypad for the RUN Command - the RUN command causes the inverter to accelerate the motor to the selected speed. You can program the inverter to respond to either the control terminal signal or the keypad START key. Follow the steps in the table below to select the front panel START key as the source for the RUN Command (the table resumes action from the end of the previous table).















Action	Display	Func./Parameter
Press the  key.		Run command source
Press the  key.		1 = control terminals (default) 2 = keypad
Press the  key.		2 = keypad (selected)
Press the  key.		Stores parameter, returns to “A” group list

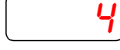

NOTE: When you press the ENTER key in the last step above (and the display = 02), the Run Enable LED above the START key on the keypad will turn ON. This is normal, and does not mean the motor is trying to run. It means that the START key is now enabled. DO NOT press the START key at this time — finish the programming exercise first.

Configure the Inverter for the Number of Motor Poles- the number of magnetic poles of a motor is determined by the motor's internal winding arrangement. The specifications label on the motor usually indicates its number of poles. For proper operation, verify the parameter setting matches the motor poles. Many industrial motors have four poles, which is the default setting in the inverter.

Follow the steps in the table below to verify the motor poles setting and change it if necessary (the table resumes action from the end of the previous table.)

Action	Display	Func./Parameter
Press the  key.		"A" group selected
Press the  key three times.		"H" group selected
Press the  key.		First "H" parameter
Press the  key three times.		Motor poles parameter
Press the  key.		2 = 2 poles 4 = 4 poles (default) 6 = 6 poles 8 = 8 poles
Press the  or  key as needed.		Set to match your motor (your display may be different)
Press the  key.		Stores parameter, returns to "H" group list

This step concludes the parameter setups for the inverter. You are almost ready to run the motor for the first time!



TIP: If you became lost during any of these steps, first observe the state of the PRG LED. Then study the keypad navigation on page 2-22 to determine the current state of the keypad controls and display. As long as you do not press the Enter key, no parameters will be changed by keypad entry errors. Note that power cycling the inverter will not cause it to reset to a particular programming state.

The next section will show you how to monitor a particular parameter from the display. Then you will be ready to run the motor.

Monitoring Parameters with the Display

After using the keypad for parameter editing, it's a good idea to switch the inverter from Program Mode to Monitor Mode and close the panel door (puts the keys for parameter editing out of sight). This will also turn out the PRG LED, and the Hertz or Ampere LED indicates the display units.

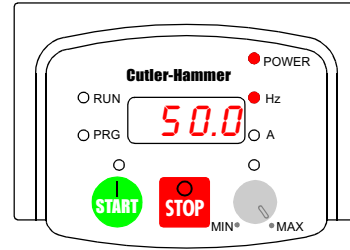

For the powerup test, let's monitor the motor speed indirectly by viewing the inverter's output frequency. The *output frequency* must not be confused with *base frequency* (50/60 Hz) of the motor, or the *carrier frequency* (switching frequency of the inverter, in the kHz range). The monitoring functions are in the "D" list, located near the top left of the keypad navigation diagram.

Output frequency (speed) monitor - Resuming the keypad programming from the previous table, follow the steps in the table below.

Action	Display	Func./Parameter
Press the key.		"H" group selected
Press the key.		Output frequency selected
Press the key.		Output frequency displayed

When the function code appeared, the PRG LED went off. This confirms the inverter is no longer in programming mode, even while you are selecting the particular monitoring parameter. After pressing the key, the display shows the current speed (which is zero at this point).

Running the Motor

If you have programmed all the parameters up to this point, you're ready to run the motor! First, review this checklist:

1. Verify the Power LED is on. If not, check the power connections.
2. Verify the Run Enable LED is on. If not, review the programming steps to find the problem.
3. Verify the PRG LED is off. If it is on, review the instructions above.
4. Make sure the motor is disconnected from any mechanical load.
5. Turn the potentiometer to the MIN position (completely counter clock-wise).
6. Now, press the START key on the keypad. The RUN LED will turn on.
7. Slowly increase the potentiometer setting in clockwise fashion. The motor should start turning when the indicator is in the 9:00 position and beyond.
8. Press the STOP key to stop the motor rotation.

Inverter Mounting and Installation

Powerup Test Observations and Summary



Step 10: Reading this section will help you make some useful observations when first running the motor.

Error Codes - If the inverter displays an error code (LED format is “*EXX*”), see the instructions on page 6-5 to interpret and clear the error.

Acceleration and Deceleration - The AF91sv inverter has programmable acceleration and deceleration values. The test procedure left these at the default value, 10 seconds. You can observe this by setting the potentiometer at about half speed before running the motor. Then press RUN, and the motor will take 5 seconds to reach a steady speed. Press the STOP key to see a 5 second deceleration to a stop.

State of Inverter at Stop - If you adjust the motor’s speed to zero, the motor will slow to a near stop, and the inverter turns the outputs off. The high-performance AF91sv can rotate at a very slow speed with high torque output, but not zero (must use servo systems with position feedback for that feature). This characteristic means you must use a mechanical brake for some applications.

Interpreting the Display - First, let’s interpret the output frequency display readout. The maximum frequency setting (parameter A4) defaults to 50Hz or 60 Hz (Europe and United States, respectively) for your application.

Example: Suppose a 4-pole motor is rated for 60 Hz operation, so the inverter is configured to output 60 Hz at full scale. Let’s use the following formula to calculate the RPM.

$$\text{Speed in RPM} = \frac{\text{Frequency} \times 60}{\text{Pairs of poles}} = \frac{\text{Frequency} \times 120}{\# \text{ of poles}} = \frac{60 \times 120}{4} = 1800\text{RPM}$$

The theoretical speed for the motor is 1800 RPM (speed of torque vector rotation). However, the motor cannot generate torque unless its shaft turns at a slightly different speed. This difference is called *slip*. So it’s common to see a rated speed of approximately 1750 RPM on a 60 Hz, 4-pole motor. Using a tachometer to measure shaft speed, you can see the difference between the inverter output frequency and the actual motor speed. The slip increases slightly as the motor’s load increases. This is why the inverter output value is called “frequency,” since it is not exactly equal to motor speed. You can program the inverter to display output frequency in units more directly related to the load speed by entering a constant (discussed more in depth on page 3-23).

Run/Stop versus Monitor/Program modes – The Run LED on the inverter is On in the Run Mode, and Off in the Stop Mode. The Program LED is On when the inverter is in the Program Mode, and Off for Monitor Mode. All four mode combinations are possible. The diagram to the right depicts the modes and the mode transitions from keypad commands.

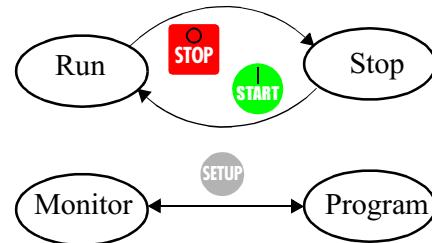

NOTE: Some factory automation devices such as PLCs have alternate Run/Program modes; the device is in either one mode or the other. In the Cutler-Hammer inverter, however, Run Mode alternates with Stop Mode, and Program Mode alternates with Monitor Mode. This arrangement lets you program some values while the inverter is operating — providing flexibility for maintenance personnel.

Configuring Drive Parameters



In This Chapter....	page
— Choosing a Programming Device	2
— Using Keypad Devices	3
— “D” Group: Monitoring Functions	6
— “D” Group: Monitoring Functions	6
— “F” Group: Main Profile Parameters	7
— “A” Group: Standard Functions	8
— “B” Group: Fine Tuning Functions	19
— “C” Group: Intelligent Terminal Functions.....	26
— “H” Group: Sensorless Vector Functions.....	34

Choosing a Programming Device

Introduction

Cutler-Hammer adjustable frequency drives (inverters) use the latest electronics technology for getting the correct AC waveform to the motor at the right time. The benefits are many, including energy savings and higher machine output or productivity. The flexibility required to handle a broad range of applications has required ever more configurable options and parameters — inverters are now a complex industrial automation component. And this can make a product seem difficult to use, but the goal of this chapter is to make this easier for you.

As the powerup test in Chapter 2 demonstrated, you do not have to program very many parameters to run the motor. In fact, most applications would benefit only from programming just a few, specific parameters. This chapter will explain the purpose of each set of parameters, and help you decide which ones are important to your application.

If you are developing a new application for the inverter and a motor, finding the right parameters to change is mostly an exercise in optimization. Therefore, it is OK to begin running the motor with a loosely tuned system. By making specific, individual changes and observing their effects, you can achieve a finely tuned system. And, the AF91sv Series inverters have a built-in auto-tuning algorithm to set certain motor parameters.

Introduction to Inverter Programming

The front panel keypad is the first and best way to get to know the inverter's capabilities. Every function or programmable parameter is accessible from the keypad. The other devices simply imitate the keypad's layout and inverter access, while adding another valuable aspect to the system. In this way, you can use a variety of programming devices with basically the same keypad skills. The following table shows various programming options, the features unique to each device, and the cables required.

Device	Part Number	Parameter Access	Parameter setting storage
Inverter keypad	—	Monitor and program	EEPROM in inverter
Copy Unit	K13-000034-0xxx	Monitor and program	EEPROM in operator panel
Remote Display	K13-000034-0200	Monitor only	none on display

The cables below connect the inverter to the Copy Unit or the Remote Display.

Cables / Adapters			
Part number	Length	Connectors	
ICA-1J	1 meter	10-pin, dual inline 2 x 5, male	DIN, 8-pin male
ICA-0.1J	0.1 meter	10-pin, dual inline 2 x 5, female	RJ45 Modular, 8-pin, male



Using Keypad Devices

Inverter Front Panel Keypad

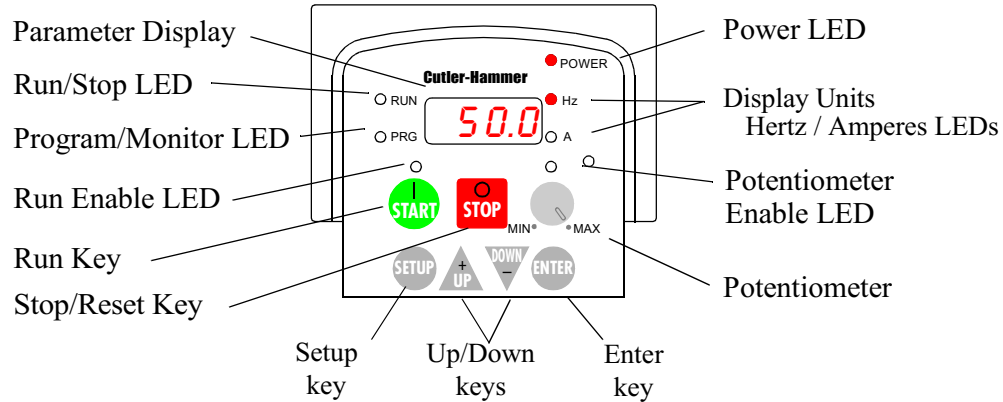
The AF91sv Series inverter front keypad contains all the elements for both monitoring and programming parameters. The keypad layout is pictured below. All other programming devices for the inverter have a similar key arrangement and function.



Key and Indicator Legend

- **Run/Stop LED** - On when the inverter output is running the motor (Run Mode), and Off when the inverter output is Off (Stop Mode).
- **Program/Monitor LED** - This LED is On when the inverter is ready for parameter editing (Program Mode). It is Off when the parameter display is monitoring data (Monitor Mode).
- **Start Key** - Press this key to run the motor (the Run Enable LED must be On first).
- **Run Enable LED** - is On when the inverter is ready to respond to the Run command, Off when the Run command is disabled.
- **Stop Key** - Press this key to stop the motor when it is running (uses the programmed deceleration rate). This key will also reset an alarm which has tripped.
- **Potentiometer** - allows an operator to enter data for selecting a scalar value from a range, associated with the inverter output frequency.
- **Potentiometer Enable LED** - On when the potentiometer is enabled for value entry.
- **Parameter Display** - a 4-digit, 7-segment display for parameters and function codes.
- **Display Units, Hertz/Amperes** - One of these LEDs will be On to indicate the units associated with the parameter display.
- **Power LED** - This LED is On when the power input to the inverter is On.
- **Setup Key** - This key is used to navigate through the lists of parameters and functions for setting and monitoring parameter values.
- **Up/Down ( , ) Keys** - Use these keys to alternately move up or down the lists of parameter and functions shown in the display, and increment/decrement values.
- **Enter () Key** - When the unit is in Program Mode and the operator has edited a parameter value, press the Store key to write the new value to the EEPROM.

Keypad Navigational Map

Whether you use the keypad on the inverter or the hand-held digital operator panel, each navigates the same way. The diagram below shows the basic navigational map of parameters and functions.

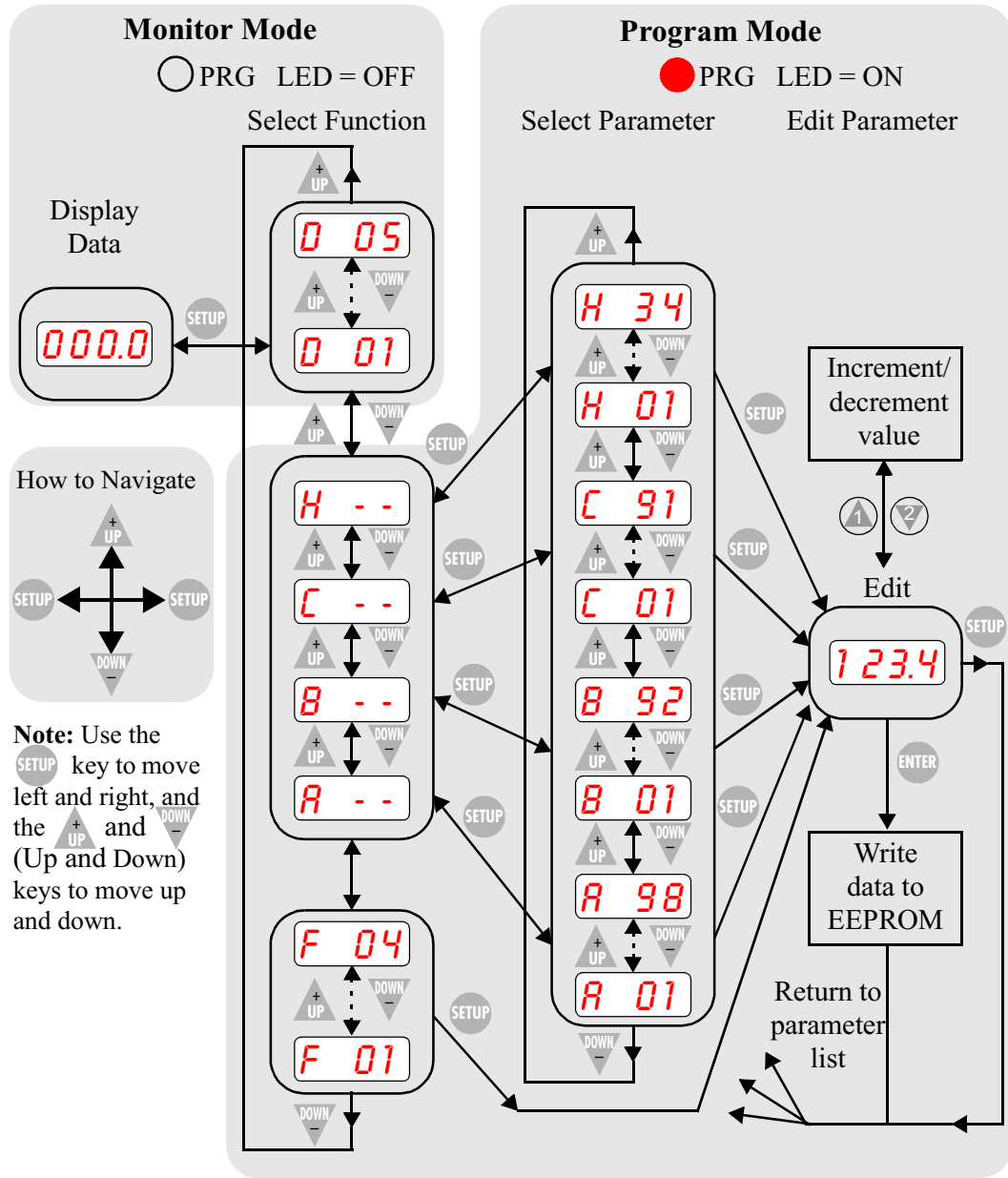

Configuring Drive Parameters



NOTE: The inverter 7-segment display shows lower case “b” and “d”, which means the same as the upper case letters “B” and “D” used in this manual (for uniformity “A to F”).



NOTE: The Enter Key saves the edited parameter (shown in the display) to the EEPROM in the inverter, regardless of the programming device. Upload and download of parameters is accomplished through a separate command.

Operational Modes

The RUN and PGM LEDs tell just part of the story; Run Mode and Program Modes are independent modes, not opposite modes. In the state diagram to the right, Run alternates with Stop, and Program Mode alternates with Monitor Mode. This is a very important ability, for it shows that a technician can approach a running machine and change some parameters without shutting down the machine.

The occurrence of a fault during operation will cause the inverter to enter the Trip Mode as shown. An event such as an output overload will cause the inverter to exit the Run Mode and turn off its output to the motor. In the Trip Mode, any request to run the motor is ignored. You must clear the error by pressing the Stop/Reset switch. See page 6-5 for error codes and trip history monitoring in detail.

The motor control program in the AF91sv inverter has three sinusoidal PWM switching algorithms. The intent is that you select the best algorithm for the motor characteristics in your application. Each algorithm generates the frequency output in a unique way. Once configured, the algorithm is the basis for other parameter settings as well (see page 3-11). Therefore, choose the best algorithm early in your application design process.

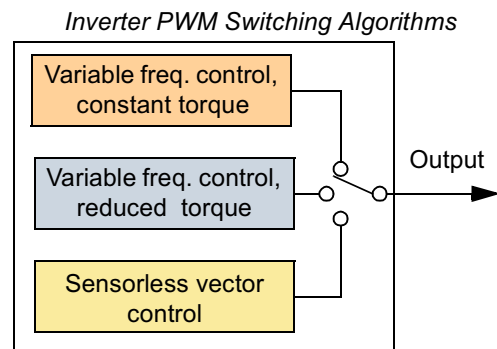
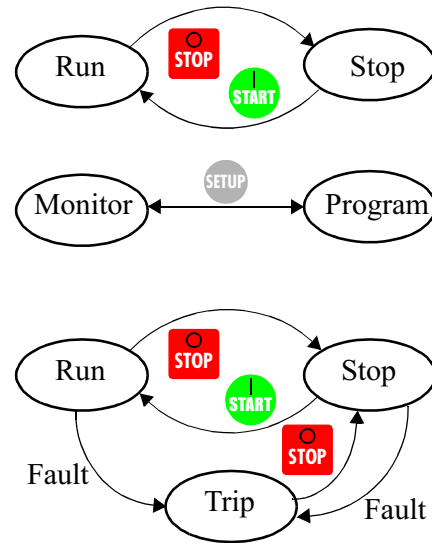

Configuring Drive Parameters

Other Keypad Programming / Monitoring Devices

Several hand-held programming devices are available:

- Copy Unit (shown at right) – The keypad on the Copy Unit is similar to the inverter keypad (refer to the manual that comes with each unit). These can also be panel-mounted to provide a permanent low-cost operator interface, while keeping the inverter secure within the cabinet.
- Remote Display (shown below) – The Remote Display can view parameters (using the D group monitoring parameters).

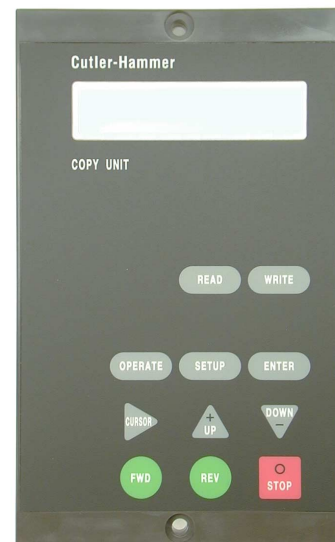

“D” Group: Monitoring Functions

Parameter Monitoring Functions

You can access important system parameter values with the “D” group monitoring functions, whether the inverter is in Run Mode or Stop Mode. After selecting the function code number for the parameter you want to monitor, press the Function key once to show the value on the display. In Functions D05 and D06, the intelligent terminals use individual segments of the display to show On/Off status.

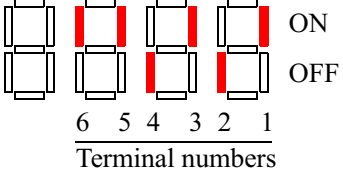
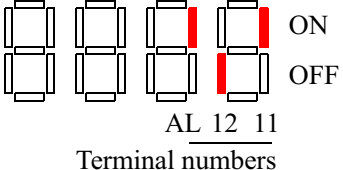
“D” Function			Run-time Edit	Range and Units	Copy Unit	
Func. Code	Name	Description			Func. Code	Name
D01	Output frequency monitor	Real-time display of output frequency to motor, from 0.0 to 360.0 Hz	—	0.0 to 360.0 Hz	Monitor: FS, 2FS, TM, VR, 1 to 15 S	
D02	Output current monitor	Filtered display of output current to motor (100 mS internal filter time constant)	—	A	Mon.	Im
D03	Rotation direction monitor	Three different indications: “F”..... Forward “ ” .. Stop “r”..... Reverse	—	—	Mon.	VR
D04	Process variable (PV), PID feedback monitor	Displays the scaled PID process variable (feedback) value (A75 is scale factor)	—	—	Monitor: FSP, 2FP, TMP, VRP, 1 to 15S	
D05	Intelligent input terminal status	Displays the state of the intelligent input terminals: 	—	—	Mon.	TERM
D06	Intelligent output terminal status	Displays the state of the intelligent output terminals: 	—	—	Mon.	TERM
D07	Scaled output frequency monitor	Displays the output frequency scaled by the constant in B86. Decimal point indicates range: XX.XX 0.01 to 99.99 XXX.X 100.0 to 999.9 XXXX. 1000 to 9999 XXXX 10000 to 99990	—	Hz	Mon.	/Hz

Configuring Drive Parameters

Trip Event and History Monitoring

The trip event and history monitoring feature lets you cycle through related information using the keypad. More details about trip event monitoring are on page 6-5.

“D” Function			Run-time Edit	Range and Units	Copy Unit	
Func. Code	Name	Description			Func. Code	Name
D08	Trip event monitor	Displays the current trip event information.	—	—	Mon.	ERR1
D09	Trip history monitor	Displays the previous two events and their causes.	—	—	Mon.	ERROR COUNT, ERR2, ERR3

“F” Group: Main Profile Parameters

The basic frequency (speed) profile is defined by parameters contained in the “F” group as shown to the right. The set running frequency is in Hz, but acceleration and deceleration are specified in the time duration of the ramp (from zero to maximum frequency, or from maximum frequency to zero). The motor direction parameter determines whether the keypad

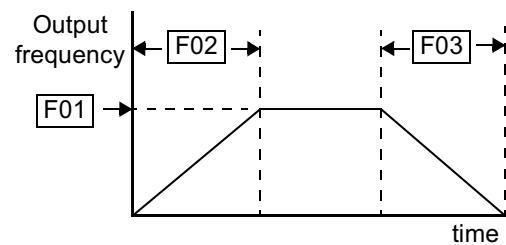

Run key produces a FWD or REV command. This parameter does not affect the intelligent terminal FWD and REV functions, which are already separate.

“F” Function			Run-time Edit	Range and Units	Copy Unit	
Func. Code	Name	Description			Func. Code	Name
F01	Output frequency setting	Standard default target frequency that determines constant motor speed	Yes	0 to 360 Hz	Mon.	FS, 2FS, TH, VR, 1 to 15S
F02	Acceleration 1	Standard default acceleration	Yes	0.1 to 3000 sec.	Mon.	ACC1
F202	Acceleration 1, 2nd motor	Standard default acceleration, 2nd motor	Yes	0.1 to 3000 sec.	Mon.	2ACC
F03	Deceleration 1	Standard default deceleration	Yes	0.1 to 3000 sec.	Mon.	DEC1
F203	Deceleration 1, 2nd motor	Standard default deceleration, 2nd motor	Yes	0.1 to 3000 sec.	Mon.	2DEC
F04	Motor direction	Two options; select codes: 00 .. Forward 01 .. Reverse	No	00, 01	Mon.	F/R-Select

“A” Group: Standard Functions

Basic Parameter Settings

These settings affect the most fundamental behavior of the inverter — the outputs to the motor. The frequency of the inverter’s AC output determines the motor speed. You may select from three different sources for the reference speed. During application development you may prefer using the potentiometer, but you may switch to an external source (control terminal setting) in the finished application, for example.

The base frequency and maximum frequency settings interact according to the graph below (left). The inverter output operation follows the constant V/F curve until it reaches the full-scale output voltage. This initial straight line is the constant-torque part of the operating characteristic. The horizontal line over to the maximum frequency serves to let the motor run faster, but at a reduced torque. If you want the motor to output constant torque over its entire operating range (limited to the motor nameplate voltage and frequency rating), then set the base frequency and maximum frequency equal as shown (below right).

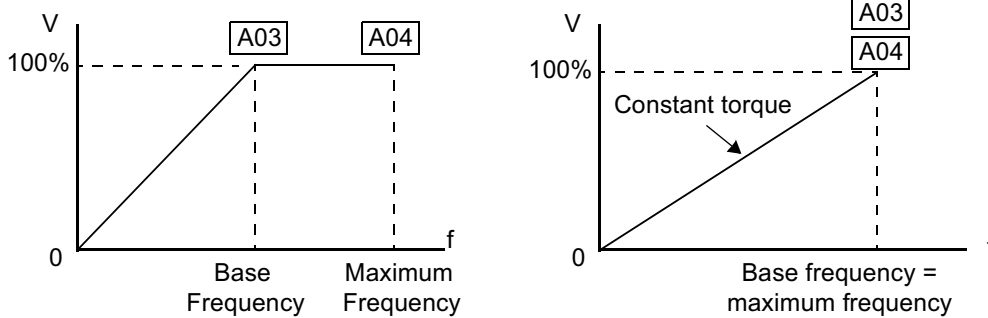

NOTE: The “2nd motor” settings in the tables in this chapter store an alternate set of parameters for a second motor. The inverter can use the 1st set or 2nd set of parameters to generate the output frequency to the motor. See the section on page 4-34 on configuring the inverter to operate with two motors.

Configuring Drive Parameters

“A” Function			Run-time Edit	Defaults		Copy Unit	
Func. Code	Name	Description		Data	Units	Func. Code	Name
A01	Frequency source setting	Three options; select codes: 00...Keypad potentiometer 01...Control terminal 02...Function F01 setting	No	00	—	Mon.	F-SET-SELECT
A02	Run command source setting	Two options; select codes: 01...Control terminal 02...Run key on keypad, or digital operator	No	02	—	Mon.	F/R-SELECT
A03	Base frequency setting	Settable from 50 Hz to the maximum frequency	No	60	Hz	F-00	F-BASE
A203	Base frequency setting, 2nd motor	Settable from 50 Hz to the maximum frequency	No	60	Hz	F00	2F-BASE

“A” Function			Run-time Edit	Defaults		Copy Unit	
Func. Code	Name	Description		Data	Units	Func. Code	Name
A04	Maximum frequency setting	Settable from the base frequency up to 360 Hz	No	60	Hz	F-01	F-MAX
A204	Maximum frequency setting, 2nd motor	Settable from the base frequency up to 360 Hz	No	60	Hz	F-01	2F-MAX

Analog Input Settings

The inverter has the capability to accept an external analog input that can command the output frequency to the motor. Voltage input (0 –10V) and current input (4–20mA) are available on separate terminals (“O” and “OI,” respectively). The analog input settings add scaling and offset adjustments between the analog input and the frequency output.

In the graph below (left), A13 and A14 select the active portion of the input voltage or current range. The parameters A11 and A12 select the start and end frequency of the converted output frequency range, respectively. Together, these four parameters define a line segment as shown (below, right). When the line does not begin at the origin, A15 defines whether the inverter outputs 0Hz or the A11 frequency when the analog input value is less than the A13 setting (determines the non-linear part of the translation).

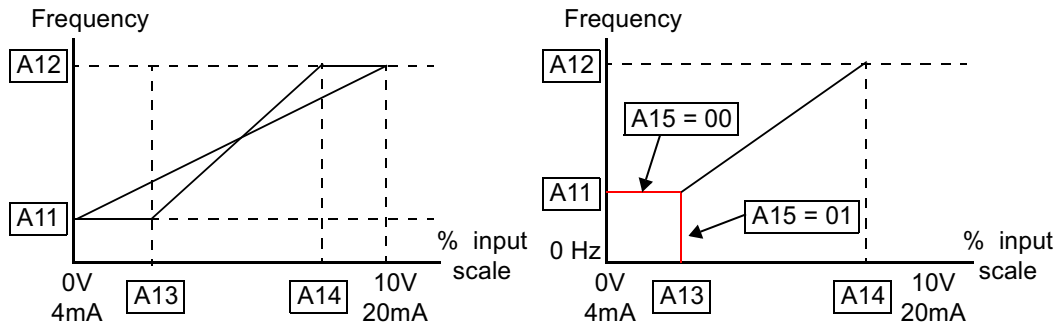

Configuring Drive Parameters

“A” Function			Run-time Edit	Defaults		Copy Unit	
Func. Code	Name	Description		Data	Units	Func. Code	Name
A11	External frequency output zero reference	The output frequency corresponding to the analog input range starting point	No	0	Hz	F-31	IN EXS
A12	External frequency output span reference	The output frequency corresponding to the analog input range ending point	No	0	Hz	F-31	IN EXE
A13	External frequency input bias start	The starting point (offset) for the active analog input range	No	0	%	F-31	IN EX%S
A14	External frequency input bias end	The ending point (offset) for the active analog input range	No	100	%	F-31	IN EX%E

"A" Function			Run-time Edit	Defaults		Copy Unit	
Func. Code	Name	Description		Data	Units	Func. Code	Name
A15	External frequency offset enable	Two options; select codes: 00...Use offset (A11 value) 01...Use 0 Hz	No	01	—	F-31	IN LEVEL
A16	External frequency filter time constant	Range n = 1 to 8, where n = number of samples for avg.	No	8	Sam- ples	F-31	IN F-SAMP

Multi-speed Frequency Setting

The AF91sv inverter has the capability to store and output up to 16 frequencies to the motor (A20 to A35). As in traditional motion terminology, we call this *multi-speed profile* capability. Binary-encoded logic inputs select the particular frequency (speed) setting, and the inverter applies the current acceleration or deceleration setting required to change from the current output frequency to the new one. The first multi-speed setting is duplicated for the second motor settings (the remaining 15 multi-speeds apply only to the first motor).

The jog speed setting is used whenever the Jog command is active. The jog speed setting range is arbitrarily limited to 10 Hz, to provide safety during manual operation. The acceleration to the jog frequency is instantaneous, but you can choose from three modes for the best method for stopping the jog operation.

"A" Function			Run-time Edit	Defaults		Copy Unit	
Func. Code	Name	Description		Data	Units	Func. Code	Name
A20	Multi-speed frequency setting	Defines the first speed of a multi-speed profile, range is 0 to 360 Hz A20 = Speed 1 (1st motor)	Yes	0	Hz	F-11	SPD FS
A220	Multi-speed frequency setting, 2nd motor	Defines the first speed of a multi-speed profile for 2nd motor, range is 0 to 360 Hz A20 = Speed 1 (2nd motor)	Yes	0	Hz	F-11	SPD 2FS
A21 to A35	Multi-speed frequency settings (for both motors)	Defines 15 more speeds, range is 0 to 360 Hz. A21 = Speed 2... A35 = Speed 16	Yes	0 (all)	Hz	F-11	SPD 1 to SPD 15
A38	Jog frequency setting	Defines limited speed for jog, range is 0.5 to 9.99 Hz	Yes	1.0	Hz	Mon.	JOGGING
A39	Jog stop mode	Define how end of jog stops the motor; three options: 00...Free-run stop 01...Controlled deceleration 02...DC braking to stop	No	00	—	Mon.	JOG MODE

V/F Characteristics

When the motor load has a lot of inertia or starting friction, you may need to increase the low frequency starting torque characteristics by boosting the voltage above the normal V/F ratio (shown at right). The boost is applied from zero to 1/2 the base frequency. You set the breakpoint of the boost (point A on the graph) by using parameter A43. The manual boost is calculated as an addition to the standard straight V/F line (constant torque curve).

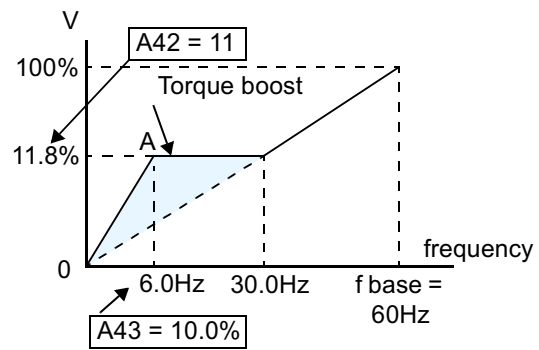

NOTE: Manual torque boost is not operational when sensorless vector control is in use.

Be aware that running the motor at a low speed for a long time can cause motor overheating. This is particularly true when manual torque boost is on, or if the motor relies on a built-in fan for cooling.

Parameter A44 selects the inverter algorithm for generating the frequency output, as shown in the diagram to the right. The inverter generates the motor output according to the V/F algorithm or the sensorless vector control algorithm. The V/F curve is oriented toward developing constant torque or reduced torque (see graph below, left). In sensorless vector control, the inverter calculates an ideal torque vector based on current motor position, winding currents, and so on. It is the more robust control method, but you can select either V/F control or sensorless vector control.

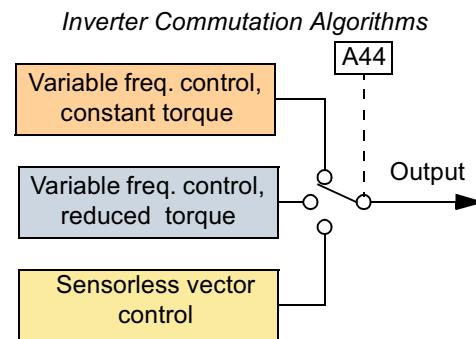

Configuring Drive Parameters

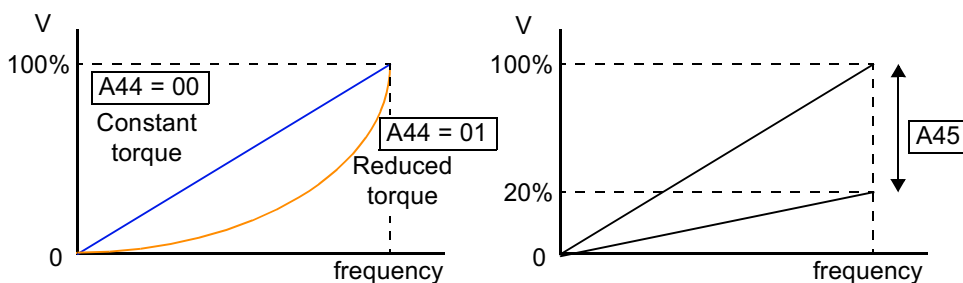

A44 = 02 for sensorless vector control

Using parameter A45 you can modify the voltage gain of the inverter (see graph above, right). This is specified as a percentage of the full scale setting (Automatic Voltage Regulation) AVR level in parameter-F03. The gain can be set from 20% to 100%. It should be adjusted in accordance with the motor specifications.



NOTE: When the inverter is in SLV (sensorless vector) mode, use B83 to set the carrier frequency greater than 2.1 kHz for proper operation. When the data of the H Group parameters does not match that of the motor, satisfactory characteristics may not be obtained during sensorless vector operation. Also, the stabilization adjustment (H06) is effective for V/F settings (00 and 01). The full performance may not be achieved if the rating of a motor used is more than one frame size smaller than the maximum applicable rating when the sensorless vector function is used. You must disable sensorless vector operation when two or more motors are connected. For the motor stabilization, set this data properly for the H03 (H203) parameter according to the motor used if its rating is not the same as the maximum applicable rating in V/F operation.

The following table shows the methods of torque control selection.

“A” Function			Run-time Edit	Defaults		Copy Unit	
Func. Code	Name	Description		Data	Units	Func. Code	Name
A41	Torque boost method selection	Two options: 00...Manual torque boost 01...Automatic torque boost	No	00	—	F-50	V-BOOST MODE
A241	Torque boost method selection, 2nd motor	Two options (for 2nd motor): 00...Manual torque boost 01...Automatic torque boost	No	00	—	F-50	2V-BOOST MODE
A42	Manual torque boost value	Can boost starting torque between 0 and 99% above normal V/F curve, from 0 to 1/2 base frequency	Yes	11	—	F-50	V-BOOST CODE
A242	Manual torque boost value, 2nd motor	Can boost starting torque between 0 and 99% above normal V/F curve, from 0 to 1/2 base frequency	Yes	11	—	F-50	2V-BOOST CODE
A43	Manual torque boost frequency adjustment	Sets the frequency of the V/F breakpoint A in graph (top of previous page) for torque boost	Yes	10	%	F-50	V-BOOST F
A243	Manual torque boost frequency adjustment, 2nd motor	Sets the frequency of the V/F breakpoint A in graph (top of previous page) for torque boost	Yes	10	%	F-50	2V-BOOST F
A44	V/F characteristic curve selection	Two available V/F curves; three select codes: 00...Constant torque 01...Reduced torque 02...Sensorless vector control	No	0	—	F-04	Control
A244	V/F characteristic curve selection, 2nd motor	Two available V/F curves; three select codes: 00...Constant torque 01...Reduced torque 02...Sensorless vector control	No	0	—	F-04	2Control
A45	V/F gain setting	Sets voltage gain of the inverter from 20 to 100%	Yes	100	%	Mon.	V-GAIN

DC Braking Settings

The DC braking feature provides additional stopping power when compared to just a normal deceleration to a stop. DC braking is particularly useful at the low frequency end of the deceleration ramp where there is little or no motor torque available for stopping. If you enable DC braking, it turns on during deceleration at a frequency you can specify. If desirable, you can specify a delay time during which the motor coasts (free runs) before DC braking helps stop the rotation.

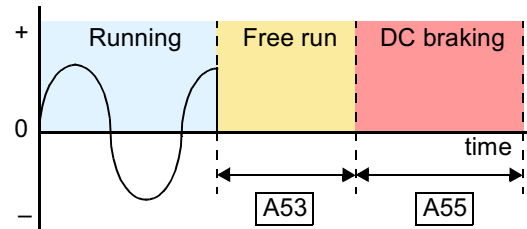

Most importantly, the force and duration of DC braking are adjustable. Be careful to not specify a long braking time that causes motor overheating. If you use DC braking, we recommend using a motor with a built-in thermistor, and wiring it to the inverter's thermistor input (see page 4-19). Also refer to the motor manufacturer's specifications for duty-cycle recommendations during DC braking.

"A" Function			Run-time Edit	Defaults		Copy Unit	
Func. Code	Name	Description		Data	Units	Func. Code	Name
A51	DC braking enable	Two options; select codes: 00...Disable 01...Enable	No	00	—	F-20	DCB SW
A52	DC braking frequency setting	The frequency at which DC braking occurs, range is 0.5 to 10 Hz	No	0.5	Hz	F-20	DCB F
A53	DC braking wait time	The delay from the end of Run command to start of DC braking (motor free runs until DC braking begins)	No	0.0	sec.	F-20	DCB WAIT
A54	DC braking force setting	Applied level of DC braking force, settable from 0 to 100%	No	0	%	F-20	DCB V
A55	DC braking time setting	Sets the duration for DC braking, range is 0.1 to 60.0 seconds	No	0.0	sec.	F-20	DCB T

Frequency-related Functions

The inverter output generates an adjustable frequency waveform that determines the motor speed (minus slip losses). You can configure the lower frequency limit to be greater than zero as shown in the graph (below left). The upper limit must not exceed the rating of the motor or capability of the machinery. Some motors or machines exhibit resonances at a particular speed, which can be destructive. The inverter has up to three *jump frequencies* (see graph, below right) with hysteresis around them to cause the inverter output to skip around the sensitive frequency values.

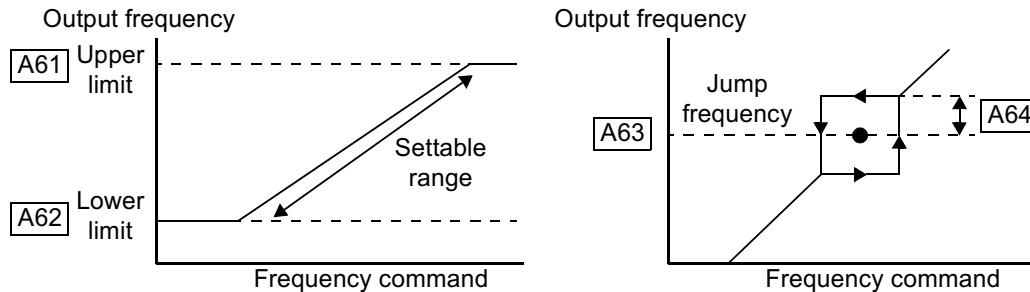

Configuring Drive Parameters

“A” Function			Run-time Edit	Defaults		Copy Unit	
Func. Code	Name	Description		Data	Units	Func. Code	Name
A61	Frequency upper limit setting	Sets a limit on output frequency less than the maximum frequency (A04) Range is 0.5 to 360.0 Hz 0.0..setting is disabled >0.1 setting is enabled	No	0.0	Hz	F-26	LIMIT H
A62	Frequency lower limit setting	Sets a limit on output frequency greater than zero Range is 0.5 to 360.0 Hz 0.0..setting is disabled >0.1 setting is enabled	No	0.0	Hz	F-26	LIMIT L
A63, A65, A67	Jump (center) frequency setting	Up to 3 output frequencies can be defined for the output to jump past to avoid motor resonances (center frequency) Range is 0.0 to 360.0 Hz	No	0.0 0.0 0.0	Hz	F-27	JUMP F1 JUMP F2 JUMP F3
A64, A66, A68	Jump (hysteresis) frequency width setting	Defines the distance from the center frequency at which the jump around occurs Range is 0.0 to 10.0 Hz	No	0.5 0.5 0.5	Hz	F-27	JUMP W1 JUMP W2 JUMP W3

PID Control

When enabled, the built-in PID loop calculates an ideal inverter output value to cause a loop feedback process variable (PV) to move closer in value to the setpoint (SP). The current frequency command serves as the SP. The PID loop calculations will read the analog input for the process variable (you specify the current or voltage input) and calculate the output. A scale factor in A75 lets you multiply the PV by a factor, converting it into engineering units for the process. Proportional, integral, and derivative gains are all adjustable. See page 4-33 for more information on PID control.

“A” Function			Run-time Edit	Defaults		Copy Unit	
Func. Code	Name	Description		Data	Units	Func. Code	Name
A71	PID Function Enable	Enables PID function, two option codes: 00...PID Disable 01...PID Enable	No	00	—	F-43	PID SW
A72	PID proportional gain	Proportional gain has a range of 0.2 to 5.0	No	1.0	—	F-43	PID P
A73	PID integral time constant	Integral time constant has a range of 0.0 to 150 seconds	No	1.0	sec.	F-43	PID I
A74	PID derivative gain	Derivative gain has a range of 0.0 to 100 seconds	No	0.0	sec.	F-43	PID D
A75	PV scale conversion	Process Variable (PV) scale factor (multiplier), range of 0.01 to 99.99	No	1.0	—	F-43	PID CONV
A76	PV source setting	Selects source of Process Variable (PV), option codes: 00...“OI” terminal (current in) 01...“O” terminal (voltage in)	No	00	—	F-43	PID INPT



NOTE: The setting A73 for the integrator is the integrator’s time constant T_i , not the gain. The integrator gain $K_i = 1/T_i$. When you set A73 = 0, the integrator is disabled.

Automatic Voltage Regulation (AVR) Function

The automatic voltage regulation (AVR) feature keeps the inverter output waveform at a relatively constant amplitude during power input fluctuations. This can be useful if the installation has an erratic power source. However, the inverter cannot boost its motor output to a voltage higher than the power input voltage. If you enable this feature, be sure to select the proper voltage class setting for your motor.

"A" Function			Run-time Edit	Defaults		Copy Unit	
Func. Code	Name	Description		Data	Units	Func. Code	Name
A81	AVR function select	Automatic (output) voltage regulation, selects from three type of AVR functions, three option codes: 00...AVR enabled 01...AVR disabled 02...AVR enabled except during deceleration	No	02	—	F-03	AVR MODE
A82	AVR voltage select	200V class inverter settings:200/220/230/240 400V class inverter settings:380/400/415/440/460	No	230/ 230, 400/ 460	V	F-03	AVR AC

Second Acceleration and Deceleration Functions

The AF91sv inverter features two-stage acceleration and deceleration ramps. This gives flexibility in the profile shape, and can avoid jerk (mechanical shock) while approaching steady frequency (or stop) more gently. You can specify the frequency transition point, the point at which the standard acceleration (F02) or deceleration (F03) changes to the second acceleration (A92) or deceleration (A93). These profile options are also available for the second motor settings. Select a transition frequency method via A94 as depicted below. Be careful not to confuse the *second acceleration/deceleration settings* with settings for the *second motor*!

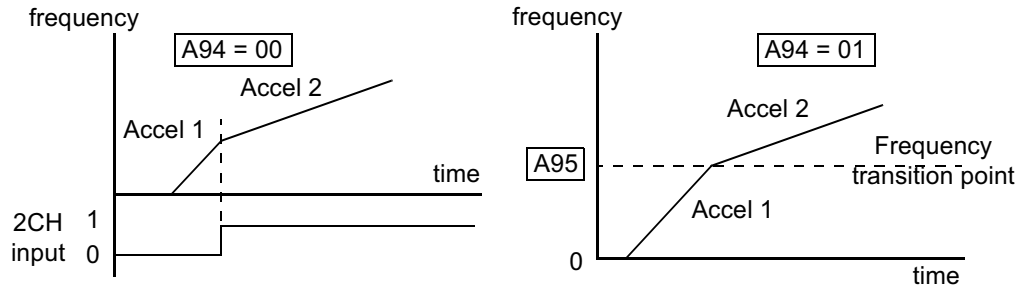

Standard acceleration and deceleration is linear. The inverter CPU can also calculate an S-curve acceleration and deceleration curve as shown. This profile avoids abrupt changes in velocity, to reduce shock to the motor load. The CPU fits the S-curve acceleration or deceleration to a time period you specify. It is also possible to have a linear acceleration and an S-curve deceleration, for example.

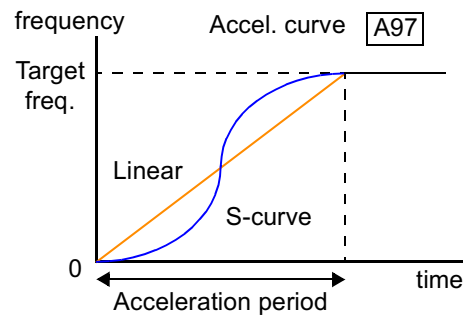

To enable the S-curve, use function A97 (acceleration) and A98 (deceleration).

"A" Function			Run-time Edit	Defaults		Copy Unit	
Func. Code	Name	Description		Data	Units	Func. Code	Name
A92	Second acceleration time setting	Duration of 2nd segment of acceleration, range is: 0.1 to 3000 sec.	Yes	15.0	sec.	F-06	ACC2
A292	Second acceleration time setting (2nd motor)	Duration of 2nd segment of acceleration, 2nd motor, range is: 0.1 to 3000 sec.	Yes	15.0	sec.	F-06	2ACC2
A93	Second deceleration time setting	Duration of 2nd segment of deceleration, range is: 0.1 to 3000 sec.	Yes	15.0	sec.	F-07	DEC 2
A293	Second deceleration time setting (2nd motor)	Duration of 2nd segment of deceleration, 2nd motor, range is: 0.1 to 3000 sec.	Yes	15.0	sec.	F-07	2DEC 2

"A" Function			Run-time Edit	Defaults		Copy Unit	
Func. Code	Name	Description		Data	Units	Func. Code	Name
A94	Select method to use second accel/decel	Two options for switching from 1st to 2nd accel/decel: 00...2CH input from terminal 01...transition frequency	No	00	—	F-06	ACC CHG
A294	Select method to use second accel/decel, 2nd motor	Two options for switching from 1st to 2nd accel/decel: 00...2CH input from terminal 01...transition frequency (2nd motor)	No	00	—	F-06	2ACC CHG
A95	Acc1 to Acc2 frequency transition point	Output frequency at which Accel1 switches to Accel2, range is 0.0 to 360.0 Hz	No	0.0	Hz	F-06	ACC CHFr
A295	Acc1 to Acc2 frequency transition point, 2nd motor	Output frequency at which Accel1 switches to Accel2, range is 0.0 to 360.0 Hz (2nd motor)	No	0.0	Hz	F-06	2ACC CHFr
A96	Dec1 to Dec2 frequency transition point	Output frequency at which Decel1 switches to Decel2, range is 0.0 to 360.0 Hz	No	0.0	Hz	F-07	DEC CHFr
A296	Dec1 to Dec2 frequency transition point, 2nd motor	Output frequency at which Decel1 switches to Decel2, range is 0.0 to 360.0 Hz (2nd motor)	No	0.0	Hz	F-07	2DEC CHFr
A97	Acceleration curve selection	Set the characteristic curve of Acc1 and Acc2, two options: 00...linear 01...S-curve	No	00	—	F-06	ACC LINE
A98	Deceleration curve setting	Set the characteristic curve of Acc1 and Acc2, two options: 00...linear 01...S-curve	No	00	—	F-07	DEC LINE



NOTE: For A95 and A96 (and for 2nd motor settings), if you set a very rapid Acc1 or Dec1 time (less than 1.0 second), the inverter may not be able to change rates to Acc2 or Dec2 before reaching the target frequency. In that case, the inverter decreases the rate of Acc1 or Dec1 in order to achieve the second ramp to the target frequency.

“B” Group: Fine Tuning Functions

The “B” group of functions and parameters adjust some of the more subtle but useful aspects of motor control and system configuration.

Restart Mode

The restart mode determines how the inverter will resume operation after a fault causes a trip event. The four options provide advantages for various situations. The inverter can restart several times for particular trip events:

- Over-current trip, restart up to 3 times
- Over-voltage trip, restart up to 3 times
- Under-voltage trip, restart up to 16 times

When the inverter reaches the maximum number of restarts (3 or 16), you must power-cycle the inverter to reset its operation.

Other parameters specify the allowable under-voltage level and the delay time before restarting. The proper settings depends on the typical fault conditions for your application, the necessity of restarting the process in unattended situations, and whether restarting is always safe.

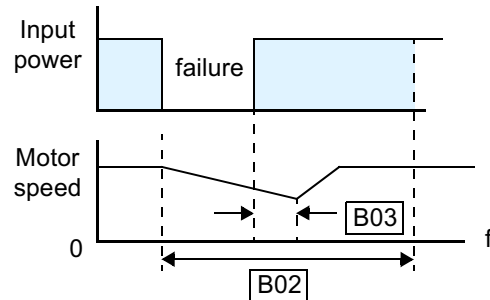

“B” Function			Run-time Edit	Defaults		Copy Unit	
Func. Code	Name	Description		Data	Units	Func. Code	Name
B01	Selection of restart mode	Select inverter restart method, four option codes: 00... Alarm output after trip, no automatic restart 01... Restart at 0Hz 02... Resume operation after frequency matching 03... Resume previous freq. after freq. matching, then decelerate to stop and display trip info.	No	00	—	F-22	IPS POWR
B02	Allowable under-voltage power failure time	The amount of time a power input under-voltage can occur without tripping the power failure alarm. Range is 0.3 to 25 sec. If under-voltage exists longer than this time, the inverter trips, even if the restart mode is selected.	No	1.0	sec.	F-22	IPS UVTIME
B03	Time delay enforced before motor restart	Time delay after under-voltage condition goes away, before the inverter runs motor again. Range is 0.3 to 100 seconds.	No	1.0	sec.	F-22	IPS WAIT

Electronic Thermal Overload Alarm Setting

The thermal overload detection protects the inverter and motor from excessive heat. First use B13 to select the torque characteristic as a function of frequency. For example, a motor can overheat if it runs for too long at a low speed. You can counteract this effect by reducing the torque at low speed. Otherwise, use the constant torque characteristic.

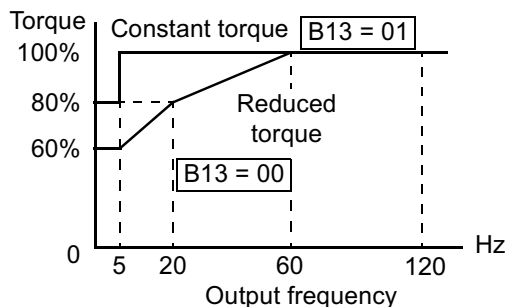

The torque developed in a motor is directly proportional to the current in the windings, which is also proportional to the heat generated (and temperature, over time). Therefore, you must set the thermal overload threshold in terms of current (amperes) for parameter B12. The range is 50% to 120% of the rated current for each model of inverter. If the current exceeds the level you specify, the inverter will trip and log an event (error E5) in the history table. The inverter turns the motor output off when tripped. Settings for the second motor are programmable separately.

Configuring Drive Parameters

“B” Function			Run-time Edit	Defaults		Copy Unit	
Func. Code	Name	Description		Data	Units	Func. Code	Name
B12	Level of electronic thermal setting	Set a level between 50% and 120% for the rated inverter current.	No	rated Amps *Note	%	F-23	E-THM LVL
B212	Level of electronic thermal setting, 2nd motor	Set a level between 50% and 120% for the rated inverter current.	No	rated Amps *Note	%	F-23	2E-THM LVL
B13	Electronic thermal characteristic	Select from two curves, option codes: 00...(SUB) reduced torque 01...(CRT) constant torque	No	01	A	F-23	E-THM Char Sub
B213	Electronic thermal characteristic, 2nd motor	Select from two curves, option codes: 00...(SUB) reduced torque 01...(CRT) constant torque	No	01	A	F-23	2E-THM Char Sub



NOTE: For inverter models BF50D, B001D, and C005D, the thermal value is less than the rated amperes. Therefore, be sure to set the electronic thermal overload according to the actual motor driven by the particular inverter.

Overload Restriction

When the inverter output current exceeds a preset current level you specify, the overload restriction feature arbitrarily reduces the output current. This feature does not generate an alarm or trip event. You can instruct the inverter to apply overload restriction only during constant speed, thus allowing higher currents for acceleration. Or, you may use the same threshold for both acceleration and constant speed.

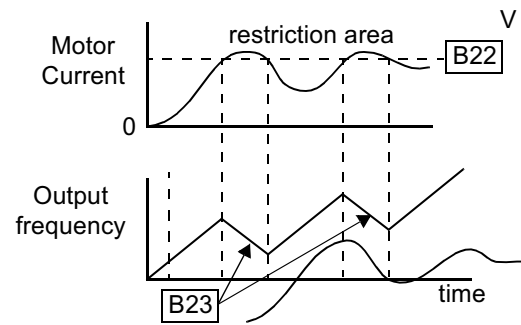

When the inverter detects an overload, it must decelerate the motor to reduce the current until it is less than the threshold. You can choose the rate of deceleration that the inverter uses to lower the output current.

“B” Function			Run-time Edit	Defaults		Copy Unit	
Func. Code	Name	Description		Data	Units	Func. Code	Name
B21	Overload restriction operation mode	Select the operating mode during overload conditions, three options, option codes: 00... Disabled 01... Enabled for acceleration and constant speed 02... Enabled for constant speed only	No	01	—	F24	OLOAD MODE
B22	Overload restriction setting	Sets the level for overload restriction, between 50% and 150% of the rated current of the inverter, setting resolution is 1% of rated current	No	rated Amps *1.25 See *Note	A	F24	OLOAD LVL
B23	Deceleration rate at overload restriction	Sets the deceleration rate when inverter detects overload, range is 0.1 to 30.0, resolution is 0.1.	No	1.0	—	F24	OLOAD CONST



NOTE: For inverter models BF50D, B001D, and C005D, the thermal value is less than the rated amperes. Therefore, be sure to set the electronic thermal overload according to the actual motor driven by the particular inverter.

Software Lock Mode

The software lock function keeps personnel from accidentally changing parameters in the inverter memory. The feature has some options, but the software lock function (B21) is not protected from operator editing. You can lock all other parameters except the output frequency (F01), if desired. This allows the user to vary only the output frequency.



NOTE: Since the software lock function B31 is always accessible, this feature is not the same as password protection used in other industrial control devices.

“B” Function			Run-time Edit	Defaults		Copy Unit	
Func. Code	Name	Description		Data	Units	Func. Code	Name
B31	Software lock mode selection	Prevents parameter changes, in four options, option codes: 00...all parameters except B31 are locked when SFT from terminal is on 01...all parameters except B31 and output frequency F01 when SFT from terminal is on 02...all parameters except B31 are locked 03...all parameters except B31 and output frequency F01 setting are locked	No	01	—	F25	S-LOCK



NOTE: If redundant data protection is necessary, use one of the intelligent input terminals (1 to 5) to allow a data change only when SFT is Off.

Miscellaneous Settings

The miscellaneous settings include scaling factors, initialization modes, and others. Here we will cover some of the most important settings you may need to configure.

B83: Carrier frequency adjustment – the internal *switching frequency* of the inverter circuitry (also called the *chopper frequency*). It is called the carrier frequency because the lower AC output frequency of the inverter “rides” the carrier. The faint, high-pitched sound you hear when the inverter is in Run Mode is characteristic of switching power supplies in general. The carrier frequency is adjustable from 500 Hz to 16 kHz. The audible sound decreases at the higher frequencies. For settings above 12 kHz, you must derate the inverter output current by 20% (due to increased heating).



NOTE: When DC braking is performed, the inverter automatically holds the carrier frequency at 1 kHz.



NOTE: When the inverter is in sensorless vector mode, use B83 to set the carrier frequency greater than 2.1 kHz for proper operation.



NOTE: The carrier frequency setting must stay within specified limits for inverter-motor applications that must comply with particular regulatory agencies. For example, a European CE-approved application requires the inverter carrier to be less than 5 kHz.

B84, B85 – Initialization codes – these functions allow you to restore the factory default settings. Please refer to page 6–8 for full instructions on restoring factory defaults.

B86 – Frequency display scaling – you can convert the output frequency monitor on D01 to a scaled number monitored at function D07. For example, the motor may run a conveyor that is monitored in feet per minute. Use this formula:

$$\text{Scaled output frequency (D07)} = \text{Output frequency (D01)} \times \text{Factor (B86)}$$

B90 – Dynamic braking usage ratio – This parameter limits the amount of time the inverter can use the dynamic braking accessory device without entering the Trip Mode. Please refer to page 5–5 for more information on the dynamic braking resistor.

“B” Function			Run-time Edit	Defaults		Copy Unit	
Func. Code	Name	Description		Data	Units	Func. Code	Name
B81	Analog frequency meter adjustment	Adjust 8-bit gain to analog meter connected to terminal FM, range is 0 to 255	Yes	80	—	Mon.	ADJ
B82	Start frequency adjustment	Sets the starting frequency for the inverter output, range is 0.5 to 9.9 Hz	No	0.5	Hz	F-02	FMIN.
B83	Carrier frequency setting	Sets the PWM carrier (internal switching frequency), range is 0.5 to 16.0 kHz	No	5	kHz	F-36	CARRIER
B84	Initialization mode (parameters or trip history)	Select the type of initialization to occur, two option codes: 00 ... Trip history clear 01 ... Parameter initialization	No	00	—	F-38	INIT MODE
B85	Country code for initialization	Select default parameter values for country on initialization, four options, option codes: 00 ... Japan version 01 ... Europe version 02 ... US version 03 ... Cutler-Hammer	No	01/02	—	F-38	INIT SEL
B86	Frequency scalar conversion factor	Specify a constant to scale the displayed frequency for D07 monitor, range is 0.1 to 99.9	No	1.0	—	Mon.	/HZ
B87	STOP key enable	Select whether the STOP key on the keypad is enabled, two option codes: 00 ... enabled 01 ... disabled	No	00	—	F-28	STOP-SW
B88	Resume on FRS cancellation mode	Selects how the inverter resumes operation when the free-run stop (FRS) is cancelled, two options: 00 ... Restart from 0Hz 01 ... Restart from frequency detected from real speed of motor	No	00	—	F-10	RUN FRS

“B” Function			Run-time Edit	Defaults		Copy Unit	
Func. Code	Name	Description		Data	Units	Func. Code	Name
B89	Data select for digital operator OPE-J	Select the monitoring data to send to the hand-held digital operator, seven option codes: 01... Output frequency (D01) 02... Output current (D02) 03... Motor direction (D03) 04... PID PV feedback (D04) 05... Input states for input terminals (D05) 06... Output states for output terminals (D06) 07... Scaled output frequency (D07)	Yes	01	—	Mon.	PANEL
B90	Dynamic braking usage ratio	Selects the rate of use (in %) of the regenerative braking resistor per 100 sec. intervals, range is 0.0 to 100.0% 0% . Dynamic braking disabled >0% Enabled, per value	No	00	%	F-21	BRD-%ED
B91	Stop mode selection	Selects how the inverter stops the motor, two option codes: 00... DEC (decelerate and stop) 01... FRS (free run to stop)	No	00	—	F-10	RUN STP
B92	Cooling fan control	Selects when the fan is on per inverter operation, two options: 00... Fan is always ON 01... Fan is ON during run, OFF during stop	No	00	—	F-38	INIT FAN-CTL

“C” Group: Intelligent Terminal Functions

The six input terminals 1, 2, 3, 4, 5, and 6 can be configured for any of 19 different functions. The next two tables show how to configure the six terminals. The inputs are logical, in that they are either OFF or ON. We define these states as OFF=0, and ON=1.

The inverter comes with default options for the six terminals. These default settings are initially unique, each one having its own setting. Note that European and US versions have different default settings. You can use any option on any terminal, and even use the same option twice to create a logical OR (though usually not required).



NOTE: Terminal 5 has the ability to be a logical input, and to be an analog input for a thermistor device when the PTC function (option code 19) is assigned to that terminal.

Input Terminal Configuration

Functions and Options –The *function codes* in the following table let you assign one of nineteen options to any of the six logic inputs for the AF91sv inverters. The functions C01 through C06 configure the terminals 1 through 6 respectively. The “value” of these particular parameters is not a scalar value, but it is a discrete number that selects one option from two or more available *options*.

For example, if you set function C01=00, you have assigned option 00 (Forward Run) to terminal 1. The option codes and the specifics of how each one works are in Chapter 4.

“C” Function			Run-time Edit	Defaults		Copy Unit	
Func. Code	Name	Description		Data	Units	Func. Code	Name
C01	Terminal 1 function	Select function for terminal 1 18 options (see next section)	No	00	—	F34	IN-TM1
C02	Terminal 2 function	Select function for terminal 2 18 options (see next section)	No	01	—	F34	IN-TM2
C03	Terminal 3 function	Select function for terminal 3 18 options (see next section)	No	06	—	F34	IN-TM3
C04	Terminal 4 function	Select function for terminal 4 18 options (see next section)	No	13	—	F34	IN-TM4
C05	Terminal 5 function	Select function for terminal 5 19 options (see next section)	No	16	—	F34	IN-TM5
C06	Terminal 6 function	Select function for terminal 6 18 options (see next section)	No	18	—	F34	IN-TM6

The input logic convention is programmable for each of the six inputs. Most inputs default to normally open (active high), but you can select normally closed (active low) in order to invert the sense of the logic.

“C” Function			Run-time Edit	Defaults		Copy Unit	
Func. Code	Name	Description		Data	Units	Func. Code	Name
C11	Terminal 1 active state	Select logic convention, two option codes: 00...normally open [NO] 01...normally closed [NC]	No	00	—	F34	IN-TM O/C-1
C12	Terminal 2 active state	Select logic convention, two option codes: 00...normally open [NO] 01...normally closed [NC]	No	00	—	F34	IN-TM O/C-2
C13	Terminal 3 active state	Select logic convention, two option codes: 00...normally open [NO] 01...normally closed [NC]	No	00	—	F34	IN-TM O/C-3
C14	Terminal 4 active state	Select logic convention, two option codes: 00...normally open [NO] 01...normally closed [NC]	No	00	—	F34	IN-TM O/C-4
C15	Terminal 5 active state	Select logic convention, two option codes: 00...normally open [NO] 01...normally closed [NC]	No	00	—	F34	IN-TM O/C-5
C16	Terminal 6 active state	Select logic convention, two option codes: 00...normally open [NO] 01...normally closed [NC]	No	00	—	F34	IN-TM O/C-6



NOTE: An input terminal configured for option code 18 ([RS] Reset command) cannot be configured for normally closed operation.

Intelligent Input Terminal Overview

Each of the six intelligent terminals may be assigned any of the options in the following table. When you program one of the option codes for terminal assignments C01 to C6, the respective terminal assumes the function role of that option code. The terminal functions have a symbol or abbreviation, which we use to label a terminal using that function. For example the “Forward Run” command is [FWD]. The physical label on the terminal block connector is simply **1**, **2**, **3**, **4**, **5**, or **6**. However, schematic examples in this manual also use the terminal symbol (such as [FWD]) to show the assigned option. The option codes for C11 to C16 determines the active state of the logical input (active high or active low).

Summary Table - this table shows all nineteen intelligent input functions at a glance. Detailed descriptions of these functions, related parameters and settings, and example wiring diagrams are in Chapter 4, starting on page 4-6.

Input Function Summary Table				
Option Code	Terminal Symbol	Function Name	Description	
00	FW	Forward Run/Stop	ON	Inverter is in Run Mode, motor runs forward
			OFF	Inverter is in Stop Mode, motor stops
01	RV	Reverse Run/Stop	ON	Inverter is in Run Mode, motor runs reverse
			OFF	Inverter is in Stop Mode, motor stops
02	CF1	Multi-speed select, Bit 0 (LSB)	ON	Binary encoded speed select, Bit 0, logical 1
			OFF	Binary encoded speed select, Bit 0, logical 0
03	CF2	Multi-speed select, Bit 1	ON	Binary encoded speed select, Bit 1, logical 1
			OFF	Binary encoded speed select, Bit 1, logical 0
04	CF3	Multi-speed select, Bit 2	ON	Binary encoded speed select, Bit 2, logical 1
			OFF	Binary encoded speed select, Bit 2, logical 0
05	CF4	Multi-speed select, Bit 3 (MSB)	ON	Binary encoded speed select, Bit 3, logical 1
			OFF	Binary encoded speed select, Bit 3, logical 0
06	JG	Jogging	ON	Inverter is in Run Mode, output to motor runs at jog parameter frequency
			OFF	Inverter is in Stop Mode
07	DB	External DC Braking	ON	DC braking will be applied during deceleration
			OFF	DC braking will not be applied
08	SET	Set Second Motor	ON	The inverter uses 2nd motor parameters for generating frequency output to motor
			OFF	The inverter uses 1st (main) motor parameters for generating frequency output to motor
09	2CH	2-stage Acceleration and Deceleration	ON	Frequency output uses 2nd-stage acceleration and deceleration values
			OFF	Frequency output uses standard acceleration and deceleration values
11	FRS	Free-run Stop	ON	Causes output to turn off, allowing motor to free run (coast) to stop
			OFF	Output operates normally, so controlled deceleration stops motor

Input Function Summary Table				
Option Code	Terminal Symbol	Function Name	Description	
12	EXT	External Trip	ON	When assigned input transitions Off to On, inverter latches trip event and displays E12
			OFF	No trip event for On to Off, any recorded trip events remain in history until Reset
13	USP	Unattended Start Protection	ON	On powerup, the inverter will not resume a Run command (mostly used in the US)
			OFF	On powerup, the inverter will resume a Run command that was active before power loss
15	SFT	Software Lock	ON	The keypad and remote programming devices are prevented from changing parameters
			OFF	The parameters may be edited and stored
16	AT	Analog Input Voltage/current Select	ON	Terminal OI is enabled for current input (uses terminal L for power supply return)
			OFF	Terminal O is enabled for voltage input (uses terminal L for power supply return)
18	RS	Reset Inverter	ON	The trip condition is reset, the motor output is turned off, and powerup reset is asserted
			OFF	Normal power-on operation
19	PTC	PTC Thermistor Thermal Protection	ANLG	When a thermistor is connected to terminals 5 and L, the inverter checks for over-temperature and will cause trip event and turn off output to motor
			OPEN	A disconnect of the thermistor causes a trip event, and the inverter turns off the motor
27	UP	Remote Control UP Function	ON	Accelerates (increases output frequency) motor from current frequency
			OFF	Output to motor operates normally
28	DWN	Remote Control DOWN Function	ON	Decelerates (decreases output frequency) motor from current frequency
			OFF	Output to motor operates normally

Output Terminal Configuration

The inverter provides configuration for logic (discrete) and analog outputs, shown in the table below.

"C" Function			Run-time Edit	Defaults		Copy Unit	
Func. Code	Name	Description		Data	Units	Func. Code	Name
C21	Terminal 11 function (logical)	Select function for terminal 11, 6 options (see next section)	No	01	—	F-35	OUT-TM 1
C22	Terminal 12 function (logical)	Select function for terminal 12, 6 options (see next section)	No	00	—	F-35	OUT-TM 2
C23	Terminal FM function (analog)	Select function for terminal FM, 3 options (see next section)	No	00	—	F-37	MONITOR
C24	Alarm relay terminal function (logical)	Select function for alarm terminals 6 options (see next section)	No	05	—	F-35	OUT-TM RY

The output logic convention is programmable for terminals 11, 12, and the alarm relay terminals. The open-collector output terminals 11 and 12 default to normally open (active low), but you can select normally closed (active high) for terminal 11 in order to invert the sense of the logic. The relay already has normally open and normally closed contacts, but you can invert the logical sense of these as well.

"C" Function			Run-time Edit	Defaults		Copy Unit	
Func. Code	Name	Description		Data	Units	Func. Code	Name
C31	Reserved	Factory use only; do not change	No	00	—	F-35	OUT-TM O/C-1
C32	Terminal 11 active state	Select logic convention, two option codes: 00...normally open [NO] 01...normally closed [NC]	No	00	—	F-35	OUT-TM O/C-2
C33	Alarm relay active state	Select logic convention, two option codes: 00...normally open [NO] 01...normally closed [NC]	No	01	—	F-35	OUT-TM O/C-RY

Output Summary Table - this table shows all six functions for the logical outputs (11, 12) at a glance. Detailed descriptions of these functions, related parameters and settings, and example wiring diagrams are in Chapter 4, starting on page 4-21.

Output Function Summary Table				
Option Code	Terminal Symbol	Function Name	Description	
00	RUN	Run signal	ON	when inverter is in Run Mode
			OFF	when inverter is in Stop Mode
01	FA1	Frequency arrival type 1 signal	ON	when output to motor is at the set frequency
			OFF	when output to motor is off, or in any acceleration or deceleration ramp
02	FA2	Frequency arrival type 2 signal	ON	when output to motor is at or above the set frequency, even if in accel. or decel. ramps
			OFF	when output to motor is off, or at a level below the set frequency
03	OL	Overload advance notice signal	ON	when output current is more than the set threshold for the overload signal
			OFF	when output current is less than the set threshold for the overload signal
04	OD	Output deviation for PID control	ON	when PID error is more than the set threshold for the deviation signal
			OFF	when PID error is less than the set threshold for the deviation signal
05	AL	Alarm signal	ON	when an alarm signal has occurred and has not been cleared
			OFF	when no alarm has occurred since the last clearing of alarm(s)

Analog Summary Table - this table shows all three functions for the analog output FM (frequency meter) terminal at a glance. Detailed descriptions, related parameters and settings, and example wiring diagrams are in Chapter 4, starting on page 4-27.

Analog Function Summary Table			
Option Code	Terminal Symbol	Function Name	Description
00	A-F	Analog frequency monitor	PWM (pulse-width-modulated) voltage output which has a duty cycle proportional to the inverter output frequency
01	A	Analog current output monitor	PWM (pulse-width-modulated) voltage output which has a duty cycle proportional to the inverter output current to the motor. It reaches 100% duty cycle when the output reaches 200% of the rated inverter current.
02	D	Digital frequency output monitor	FM (frequency-modulated) voltage output with a constant 50% duty cycle. Its frequency = inverter output frequency.

Output Function Adjustment Parameters

The overload level parameter (C41) sets the motor current level at which the overload signal becomes true. The range of settings is from 0% to 200% of the rated current for the inverter. This function is for generating an early warning logic output, without causing either a trip event or a restriction of the motor current (those effects are available on other functions).

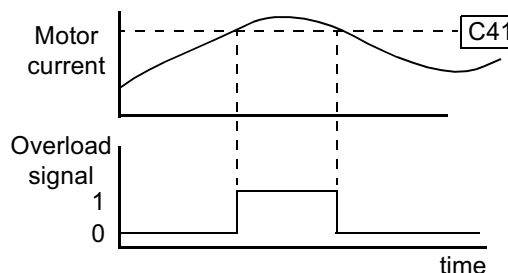

The frequency arrival signal is intended to indicate when the inverter output has reached (arrived at) the target frequency. You can adjust the timing of the leading and trailing edges of the signal via two parameters specific to acceleration and deceleration ramps, C42 and C43.

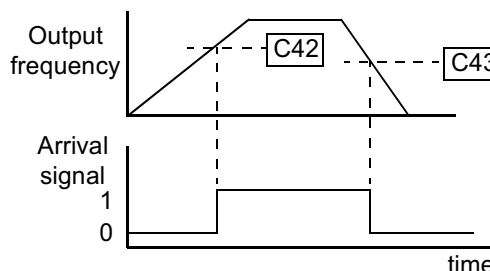

The Error for the PID loop is the magnitude (absolute value) of the difference between the Setpoint (desired value) and Process Variable (actual value). The PID output deviation signal (output terminal function option code 04) indicates when the error magnitude has exceeded a magnitude you define.

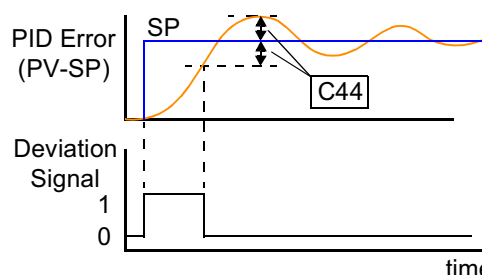

Configuring Drive Parameters

“C” Function			Run-time Edit	Defaults		Copy Unit	
Func. Code	Name	Description		Data	Units	Func. Code	Name
C41	Overload level setting	Sets the overload signal level between 0% and 200% (from 0 to two times the rated current of the inverter)	No	(rated current for each inverter)		F-33	OV Load
C42	Frequency arrival setting for accel.	Sets the frequency arrival setting threshold for the output frequency during acceleration	No	0.0	Hz	F-32	ARV ACC
C43	Arrival frequency setting for decel.	Sets the frequency arrival setting threshold for the output frequency during deceleration	No	0.0	Hz	F-32	ARV DEC
C44	PID deviation level setting	Sets the allowable PID loop error magnitude (absolute value), SP - PV, range is 0.0 to 100%, resolution is 0.1%	No	3.0	%	F-33	OV PID

“C” Function			Run-time Edit	Defaults		Copy Unit	
Func. Code	Name	Description		Data	Units	Func. Code	Name
C81	Analog meter adjustment, voltage input	Scale factor between the external frequency command on terminals L – O (voltage input) and the frequency output	No		—	Mon.	ADJ-O
C82	Analog meter adjustment, current input	Scale factor between the external frequency command on terminals L – OI (current input) and the frequency output	No		—	Mon.	ADJ-OI
C91	Debug mode selection	(Reserved) DO NOT EDIT	No	00	—	—	—
C92	Core monitor address	(Reserved) DO NOT EDIT	No	0000	—	—	—
C93	Core monitor date	(Reserved) DO NOT EDIT	No	—	—	—	—
C94	Core set address	(Reserved) DO NOT EDIT	No	d001	—	—	—
C95	Core set date	(Reserved) DO NOT EDIT	No	—	—	—	—

“H” Group: Sensorless Vector Functions

The “H” group parameters configure the inverter for the motor characteristics. You must manually set H03 and H04 values to match the motor. The remaining parameters are related to sensorless vector control (SLV), and are in use only when function A44 is set for SLV as shown in the diagram. The auto-tuning procedure on page 4–30 automatically sets all the parameters related to SLV. If you configure the inverter to use SLV, we highly recommend letting the auto-tuning procedure derive the values for you. If you want to reset the parameters to the factory default settings, use the factory default initialization procedure on page 6–8.

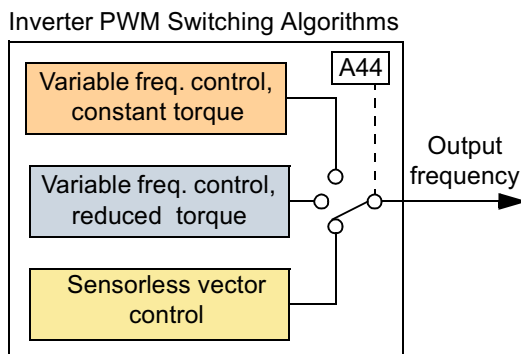

NOTE: The auto-tuning procedure and related warning messages are on page 4–30. Please read these before trying to auto-tune the motor parameters.

Configuring Drive Parameters

“H” Function			Run-time Edit	Defaults		Copy Unit	
Func. Code	Name	Description		Data	Units	Func. Code	Name
H01	Auto-tuning Setting	Three states for auto-tuning function, option codes: 00...Auto-tuning OFF 01...Auto-tune (rotate motor) 02...Auto-tune (measure motor resistance and inductance, without rotating)	No	00	—	F-05	AUX AUTO
H02	Motor data selection	Two selections, option codes: 00...Use standard motor data 01...Use auto-tuning data	No	00	—	F-05	AUX DATA
H202	Motor data selection, 2nd motor	Two selections, option codes: 00...Use standard motor data 01...Use auto-tuning data	No	00	—	F-05	2AUX DATA
H03	Motor capacity	Nine selections: 0.2 / 0.4 / 0.75 / 1.5 / 2.2 / 3.7 / 5.5 / 7.5 / 11	No	specified by the capacity of each inverter		F-05	AUX K
H203	Motor capacity, 2nd setting	Nine selections: 0.2 / 0.4 / 0.75 / 1.5 / 2.2 / 3.7 / 5.5 / 7.5 / 11	No			F-05	2AUX K
H04	Motor poles setting	Four selections: 2 / 4 / 6 / 8	No	4	poles	F-05	AUX P
H204	Motor poles setting, 2nd motor	Four selections: 2 / 4 / 6 / 8	No	4	poles	F-05	2AUX P

“H” Function			Run-time Edit	Defaults		Copy Unit	
Func. Code	Name	Description		Data	Units	Func. Code	Name
H05	Motor constant Kp	Motor proportional gain constant (factory set), range is 0 to 99	No	20	—	F-05	AUX Kp
H205	Motor constant Kp, 2nd motor	Motor proportional gain constant (factory set) range is 0 to 99	No	20	—	F-05	2AUX Kp
H06	Motor stabilization constant	Motor constant (factory set), range is 0 to 255	No	100	—	F-05	AUX KCD
H206	Motor stabilization constant, 2nd motor	Motor constant (factory set), range is 0 to 255	No	100	—	F-05	2AUX KCD
H20	Motor constant R1	Range is 0.000 to 65.53, 0.000 to 9.999 10.00 to 65.53	No	factory set	Ohms	F-05	AUX R1
H220	Motor constant R1, 2nd motor	Range is 0.000 to 65.53, 0.000 to 9.999 10.00 to 65.53	No	factory set	Ohms	F-05	2AUX R1
H21	Motor constant R2	Range is 0.000 to 65.53, 0.000 to 9.999 10.00 to 65.53	No	factory set	Ohms	F-05	AUX R2
H221	Motor constant R2, 2nd motor	Range is 0.000 to 65.53, 0.000 to 9.999 10.00 to 65.53	No	factory set	Ohms	F-05	2AUX R2
H22	Motor constant L	Range is 0.00 - 655.3 mH, 0.00 to 99.99 100.0 - 655.3	No	factory set	mH	F-05	AUX L
H222	Motor constant L, 2nd motor	Range is 0.00 - 655.3 mH, 0.00 to 99.99 100.0 - 655.3	No	factory set	mH	F-05	2AUX L
H23	Motor constant Io	Range is 0.00 to 655.3 Amps, 0.00 to 99.99 100.0 - 655.3	No	factory set	Arms	F-05	AUX IO
H223	Motor constant Io, 2nd motor	Range is 0.00 to 655.3 Amps, 0.00 to 99.99 100.0 - 655.3	No	factory set	Arms	F-05	2AUX IO
H24	Motor Constant J	Ratio (unit-less), range is 1.0 to 1000	No	factory set	—	F-05	AUX J
H224	Motor constant J, 2nd motor	Ratio (unit-less), range is 1.0 to 1000	No	factory set	—	F-05	2AUX J
H30	Motor constant R1	Auto-tuning data (do not edit)	No	factory set	—	—	—
H230	Motor constant R1, 2nd motor	Auto-tuning data (do not edit)	No	factory set	—	—	—

“H” Function			Run-time Edit	Defaults		Copy Unit	
Func. Code	Name	Description		Data	Units	Func. Code	Name
H31	Motor constant R2	Auto-tuning data (do not edit)	No	factory set	—	—	—
H231	Motor constant R2, 2nd motor	Auto-tuning data (do not edit)	No	factory set	—	—	—
H32	Motor constant L	Auto-tuning data (do not edit)	No	factory set	—	—	—
H232	Motor constant L, 2nd motor	Auto-tuning data (do not edit)	No	factory set	—	—	—
H33	Motor constant Io	Auto-tuning data (do not edit)	No	factory set	—	—	—
H233	Motor constant Io, 2nd motor	Auto-tuning data (do not edit)	No	factory set	—	—	—
H34	Motor constant J	Auto-tuning data (do not edit)	No	factory set	—	—	—
H234	Motor constant J, 2nd motor	Auto-tuning data (do not edit)	No	factory set	—	—	—

Operations and Monitoring



In This Chapter....	page
— Introduction	2
— Connecting to PLCs and Other Devices	4
— Using Intelligent Input Terminals	6
— Using Intelligent Output Terminals	21
— Analog Input Operation	27
— Analog and Digital Monitor Output	28
— Auto-tuning for Sensorless Vector Control	30
— PID Loop Operation	33
— Configuring the Inverter for Multiple Motors ...	34

Introduction

The previous chapter gave a reference listing of all the programmable functions of the inverter. We suggest that you first scan through the previous chapter's listing of inverter functions to gain a general familiarity. This chapter will build on that knowledge in the following ways:

1. **Related functions** – Some parameters interact with or depend on the settings in other functions. This chapter lists “required settings” for a programmable function to serve as a cross-reference and an aid in showing how functions interact.
2. **Intelligent terminals** – Some functions rely on an input signal on a control logic connector terminal, or generate output signals in other cases.
3. **Electrical interfaces** – This chapter shows how to make connections between the inverter and other electrical devices.
4. **Auto-tuning** – the AF91sv inverter has the ability to run a calibration procedure in which it takes measurements of the motor's electrical characteristics. This chapter shows how to run the auto-tuning procedure to help the inverter run the motor more smoothly and efficiently.
5. **PID Loop Operation** – the AF91sv has a built-in PID loop that calculates the optimal inverter output frequency to control an external process. This chapter shows the parameters and input/output terminals associated with PID loop operation.
6. **Multiple motors** – a single AF91sv inverter may be used with two or more motors in some types of applications. This chapter shows the electrical connections and inverter parameters involved in multiple-motor applications.

The topics in this chapter can help you decide which features are important to your application, and how to use them. The basic installation covered in Chapter 2 concluded with the powerup test and running the motor. Now, this chapter starts from that point and shows how to make the inverter part of a larger control or automation system.

Before continuing, please read the following safety messages.

Caution Messages for Operating Procedures



CAUTION: The heat sink fins will have a high temperature. Be careful not to touch them. Otherwise, there is the danger of getting burned.



CAUTION: The operation of the inverter can be easily changed from low speed to high speed. Be sure check the capability and limitations of the motor and machine before operating the inverter. Otherwise, it may cause injury to personnel.



CAUTION: If you operate a motor at a frequency higher than the inverter standard default setting (50Hz/60Hz), be sure to check the motor and machine specifications with the respective manufacturer. Only operate the motor at elevated frequencies after getting their approval. Otherwise, there is the danger of equipment damage.

Warning Messages for Operating Procedures



WARNING: Be sure to turn on the input power supply after closing the front case. While being energized, be sure not to open the front case. Otherwise, there is the danger of electric shock.



WARNING: Be sure not to operate the switches with wet hands. Otherwise, there is the danger of electric shock.



WARNING: While the inverter is energized, be sure not to touch the inverter terminals even when the motor is stopped. Otherwise, there is the danger of electric shock.



WARNING: If the Retry Mode is selected, the motor may suddenly restart during the trip stop. Do not approach the machine (be sure to design the machine so that safety for personnel is secure even if it restarts.) Otherwise, it may cause injury to personnel.



WARNING: If the power supply is cut off for a short period of time, the inverter may restart operation after the power supply recovers if the command to operate is active. If a restart may pose danger to personnel, so be sure to use a lock-out circuit so that it will not restart after power recovery. Otherwise, it may cause injury to personnel.



WARNING: The Stop Key is effective only when the Stop function is enabled. Be sure to enable the Key separately from the emergency stop. Otherwise, it may cause injury to personnel.



WARNING: After the operation command is given, if the alarm reset is conducted, it will restart suddenly. Be sure to set the alarm reset after verifying the operation command is off. Otherwise, it may cause injury to personnel.



WARNING: Be sure not to touch the inside of the energized inverter or to put any conductive object into it. Otherwise, there is a danger of electric shock and/or fire.



WARNING: When the power is turned on when the running command is already active, the motor will suddenly start rotation and is dangerous. Before turning the power on, confirm that the running command is not enabled.



WARNING: When the Stop key function is disabled, pressing the Stop key does not cancel the stop and trip.



WARNING: Be sure to provide a separate, hard-wired emergency stop switch. When the operation command source is a digital operator, this selection is ineffective.

Connecting to PLCs and Other Devices

Cutler-Hammer inverters (drives) are useful in many types of applications. During installation, the inverter keypad (or other programming device) will facilitate the initial configuration. After installation, the inverter will generally receive its control commands through the control logic connector or serial interface from another controlling device. In a simple application such as single-conveyor speed control, a Run/Stop switch and potentiometer will give the operator all the required control. In a sophisticated application, you may have a *programmable logic controller* (PLC) as the system controller, with several connections to the inverter.

The variety of applications is practically endless, and is beyond the scope of this manual. It will be important for you to know the electrical characteristics of the devices you want to connect to the inverter. Then, this section and the following sections on I/O terminal functions can help you quickly and safely connect those devices to the inverter.



CAUTION: It is possible to damage the inverter or other devices in your application if the maximum current or voltage characteristics of a connection point are exceeded.

The connections between the inverter and other devices rely on the electrical input/output characteristics at both ends of each connection, shown in the diagram to the right. The inverter's inputs require a sourcing output from an external device (such as a PLC). This chapter shows the inverter's internal electrical component(s) at each I/O terminal. In some cases, you will need to insert a power source in the interface wiring.

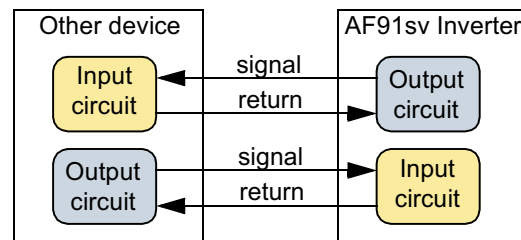

In order to avoid equipment damage and get your application running smoothly, we recommend drawing a schematic of each connection between the inverter and the other device. Include the internal components of each device in the schematic, so that it makes a complete circuit loop.

After making the schematic, then:

1. Verify that the current and voltage for each connection is within the operating limits of each device.
2. Make sure that the logic sense (active high or active low) of any ON/OFF connection is correct.
3. Check the zero and span (curve end points) for analog connections, and be sure the scale factor from input to output is correct.
4. Understand what will happen at the system level if any particular device suddenly loses power, or powers up after other devices.

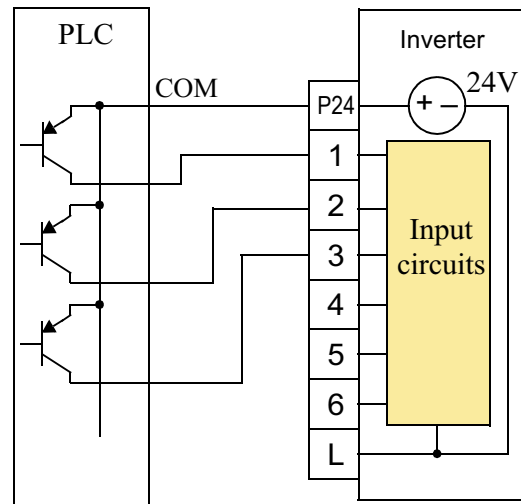

Specifications of Control and Logic Connections

The control logic connectors are located just behind the front panel half-door. The relay contacts are accessible behind the main door. Connector labeling is shown below.

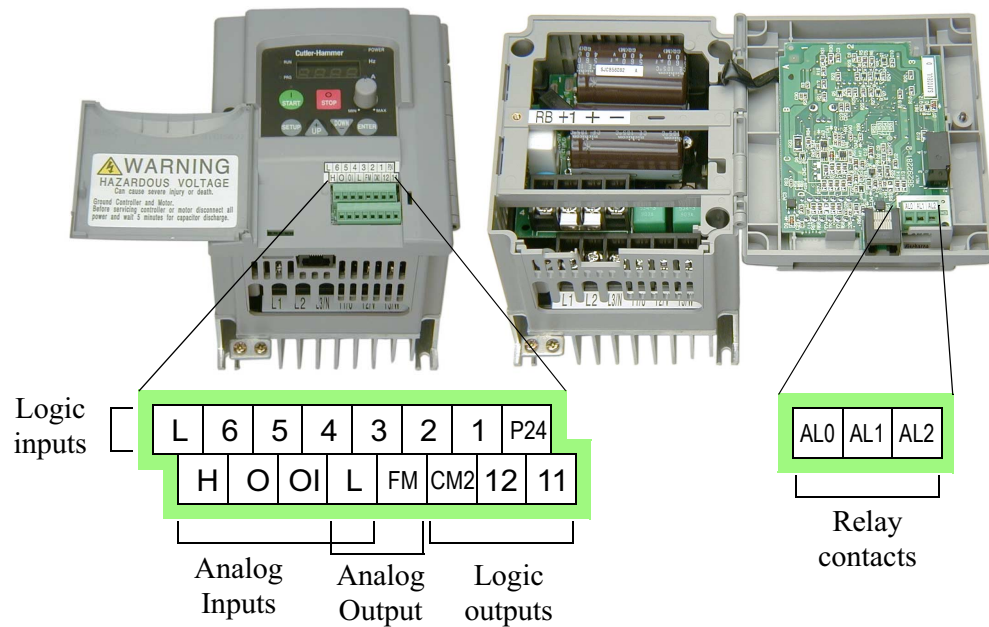

Specifications for the logic connection terminals are in the following table:

Terminal Name	Description	Ratings
P24	+24V for logic inputs	24VDC, 30 mA max (do not short to terminal L)
1, 2, 3, 4, 5, 6	Discrete logic inputs	27VDC max. (use P24 or an external supply referenced to terminal L)
L (top row) *1	GND for logic inputs	sum of input 1-6 currents (return)
11, 12	Discrete logic outputs	50mA maximum ON state current, 27 VDC maximum OFF state voltage
CM2	GND for logic outputs	100 mA: sum of 11 and 12 currents (return)
FM	PWM (analog/digital) output	0 to 10VDC, 1 mA, PWM and 50% duty digital
L (bottom row) *1	GND for analog inputs	sum of OI, O, and H currents (return)
OI	Analog input, current	4 to 19.6 mA range, 20 mA nominal
O	Analog input, voltage	0 to 9.6 VDC range, 10VDC nominal, input impedance 10 kΩ
H	+10V analog reference	10VDC nominal, 10 mA max
AL0	Relay common contact	250 VAC, 2.5A (R load) max., 250 VAC, 0.2A (I load, P.F.=0.4) max.
AL1	Relay contact, normally closed during RUN	100 VAC, 10mA min. 30 VDC, 3.0A (R load) max.
AL2	Relay contact, normally open during RUN	30 VDC, 0.7A (I load, P.F.=0.4) max. 5 VDC, 100mA min.

Note 1: The two terminals “L” are electrically connected together inside the inverter.

Using Intelligent Input Terminals

Terminals 1, 2, 3, 4, 5, and 6 are identical, programmable inputs for general use. The input circuits can use the inverter's internal (isolated) +24V field supply (P24) to power the inputs. The input circuits are internally connected to the power supply ground. As the diagram shows, you can use a switch (or jumper) to activate an input terminal which has been programmed. If you use an external supply, its GND terminal must connect to the "L" terminal on the inverter to complete the input circuit. We recommend using the top row "L" logic GND for logic input circuits and the "L" GND on the bottom row of terminals for analog I/O circuits.

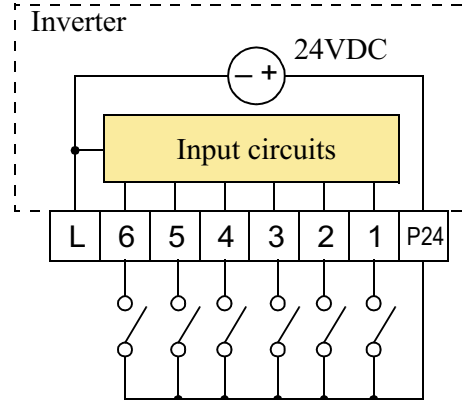

Forward Run/Stop and Reverse Run/Stop Commands:

When you input the Run command via the terminal [FW], the inverter executes the Forward Run command (high) or Stop command (low). When you input the Run command via the terminal [RV], the inverter executes the Reverse Run command (high) or Stop command (low).

Option Code	Terminal Symbol	Function Name	State	Description
00	FW	Forward Run/Stop	ON	Inverter is in Run Mode, motor runs forward
			OFF	Inverter is in Stop Mode, motor stops
01	RV	Reverse Run/Stop	ON	Inverter is in Run Mode, motor runs reverse
			OFF	Inverter is in Stop Mode, motor stops
Valid for inputs:		C01, C02, C03, C04, C05, C06		Example:
Required settings:		A02 = 01		
Notes:		<ul style="list-style-type: none"> When the Forward Run and Reverse Run commands are active at the same time, the inverter enters the Stop Mode. When a terminal associated with either [FW] or [RV] function is configured for <i>normally closed</i>, the motor starts rotation when that terminal is disconnected or otherwise has no input voltage. 		

See I/O specs on page 4-5.



WARNING: If the power is turned on and the Run command is already active, the motor starts rotation and is dangerous! Before turning power on, confirm that the Run command is not active.

Multi-Speed Select

The inverter provides storage parameters for up to 16 different target frequencies (speeds) that the motor output uses for steady-state run condition. These speeds are accessible through programming four of the intelligent terminals as binary-encoded inputs CF1 to CF4 per the table below. These can be any of the six inputs, and in any order. You can use fewer inputs if you need eight or less speeds.



Note: When choosing a subset of speeds to use, always start at the top of the table, and with the least-significant bit: CF1, CF2, etc.

The figure below shows how input switches configured with CF1 functions can change the motor speed in real time.

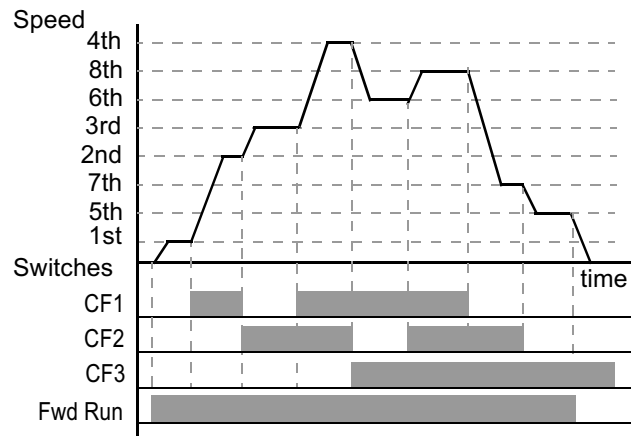

Multi-speed	Input Function			
	CF4	CF3	CF2	CF1
Speed 1	0	0	0	0
Speed 2	0	0	0	1
Speed 3	0	0	1	0
Speed 4	0	0	1	1
Speed 5	0	1	0	0
Speed 6	0	1	0	1
Speed 7	0	1	1	0
Speed 8	0	1	1	1
Speed 9	1	0	0	0
Speed 10	1	0	0	1
Speed 11	1	0	1	0
Speed 12	1	0	1	1
Speed 13	1	1	0	0
Speed 14	1	1	0	1
Speed 15	1	1	1	0
Speed 16	1	1	1	1

NOTE: Speed 1 is set by the A01 parameter value.

Option Code	Terminal Symbol	Function Name	Input State	Description
02	CF1	Multi-speed select, Bit 0 (LSB)	ON	Binary encoded speed select, Bit 0, logical 1
			OFF	Binary encoded speed select, Bit 0, logical 0
03	CF2	Multi-speed select, Bit 1	ON	Binary encoded speed select, Bit 1, logical 1
			OFF	Binary encoded speed select, Bit 1, logical 0
04	CF3	Multi-speed select, Bit 2	ON	Binary encoded speed select, Bit 2, logical 1
			OFF	Binary encoded speed select, Bit 2, logical 0
05	CF4	Multi-speed select, Bit 3 (MSB)	ON	Binary encoded speed select, Bit 3, logical 1
			OFF	Binary encoded speed select, Bit 3, logical 0

Option Code	Terminal Symbol	Function Name	Input State	Description
Valid for inputs:		C01, C02, C03, C04, C05, C06		Example: <div style="text-align: center; margin: 10px 0;"> </div>
Required settings:		F01, A20 to A35		
Notes: <ul style="list-style-type: none"> When programming the multi-speed settings, be sure to press the Store key each time and then set the next multi-speed setting. Note that when the key is not pressed, no data will be set. When a multi-speed setting more than 50Hz(60Hz) is to be set, it is necessary to program the maximum frequency A04 high enough to allow that speed. 				

See I/O specs on page 4-5.

While using the multi-speed capability, you can monitor the current frequency with monitor function D01 during each segment of a multi-speed operation.

There are two ways to program the speeds into the registers A20 to A35:

1. Standard keypad programming:
 - a. Select each parameter A20 to A35.
 - b. Press the Setup key to view the parameter value.
 - c. Use the Up and Down to edit the value.
 - d. Use the Enter key to save the data to memory.

2. Programming using the CF switches. Set the speed by following these steps:
 - a. Turn the Run command off (Stop Mode).
 - b. Turn each switch on and set it to Multi-speed n. Display the data section of F01.
 - c. Set an optional output frequency by pressing the Up and Down keys.
 - d. Press the Enter key once to store the set frequency. When this occurs, F01 indicates the output frequency of Multi-speed n.
 - e. Press the Setup key once to confirm that the indication is the same as the set frequency.
 - f. When you repeat operations in 2. a) to 2. e), the frequency of Multi-speed n can be set. It can be set also by parameters A20 to A35 in the first procedure 1. a) to 1. d).

Jogging Command

When the terminal [JG] is turned on and the Run command is issued, the inverter outputs the programmed jog frequency to the motor. Use a switch between terminals [JG] and [P24] to activate the JG frequency.

The frequency for the jogging operation is set by parameter A38.

Set the value 01 (terminal mode) in A02 (Run command). Since jogging does not use an acceleration ramp, we recommend setting the jogging frequency in A38 to 5 Hz or less to prevent tripping.

The type of deceleration used to end a motor jog is selectable by programming function A39. The options are:

- 00 Free-run stop (coasting)
- 01 Deceleration (normal level) and stop
- 02 Use DC braking and stop

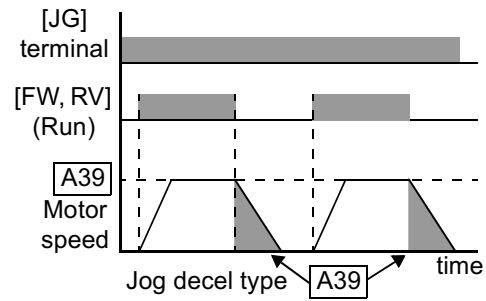

Option Code	Terminal Symbol	Function Name	Input State	Description
06	JG	Jogging	ON	Inverter is in Run Mode, output to motor runs at jog parameter frequency
			OFF	Inverter is in Stop Mode
Valid for inputs:		C01, C02, C03, C04, C05, C06		Example:
Required settings:		A02= 01, A38 > B82, A38 > 0, A39		
Notes:				
<ul style="list-style-type: none"> • No jogging operation is performed when the set value of jogging frequency A38 is smaller than the start frequency B82, or the value is 0 Hz. • Be sure to stop the motor when switching the function [JG] On or Off. 				See I/O specs on page 4-5.

External Signal for DC Braking

When the terminal [DB] is turned on, the DC braking [DB] feature is enabled. Set the following parameters when the external DC braking terminal is to be used:

1. A53 – DC braking delay time setting. The range 0.1 to 5.0 seconds.
2. A54 – DC braking force setting. The range is 0 to 100%.

The scenarios to the right help show how DC braking works in various situations.

- Scenario 1 – The [Fwd Run] or [Rev Run] terminal is On. When the [DB] terminal is On, DC braking is applied. When the [DB] terminal is Off again, the inverter output ramps to the previous frequency.
- Scenario 2 – The Run command is applied from the operator keypad. When the [DB] terminal is On, DC braking is applied. When the [DB] terminal is Off again, the inverter output remains Off.
- Scenario 3 – The Run command is applied from the operator keypad. When the [DB] terminal is On, DC braking is applied after the delay time set by A53 expires. The motor is in a free-running (coasting) condition. When the [DB] terminal is Off again, the inverter output remains Off.

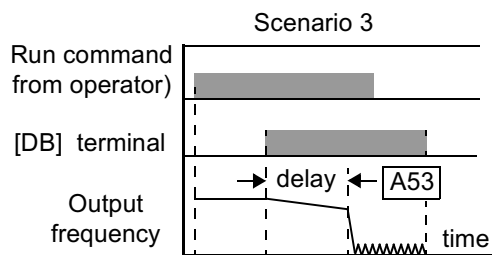
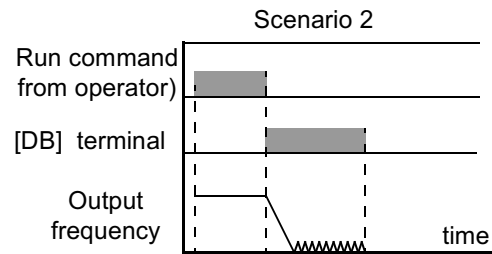
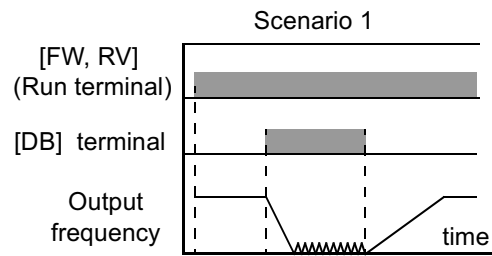

Option Code	Terminal Symbol	Function Name	Input State	Description
07	DB	External Signal for DC Injection Braking	ON	applies DC injection braking during deceleration
			OFF	does not apply DC injection braking during deceleration
Valid for inputs:		C01, C02, C03, C04, C05, C06		Example: <p>The diagram shows a terminal block with terminals L, 6, 5, 4, 3, 2, 1, and P24. Terminal 5 is connected to DB, terminal 2 to RV, and terminal 1 to FW. Terminal 4 is also connected to the DB line.</p>
Required settings:		A53, A54		
Notes:				
<ul style="list-style-type: none"> • Do not use the [DB] input continuously or for a long time when the DC braking force setting A54 is high (depends on the motor application). • Do not use the [DB] feature for continuous or high duty cycle as a holding brake. The [DB] input is designed to improve stopping performance. Use a mechanical brake for holding a stop position. 				See I/O specs on page 4-5.

Operations and Monitoring

Set Second Motor

If you assign the [SET] function to a logic terminal, the inverter will display the x2xx numbered parameters, allowing you to edit the second motor parameters. These parameters store an alternate set of motor characteristic parameters. When the terminal [SET] is turned On, the inverter will use the second set of parameters to generate the frequency output to the motor. When changing the state of the [SET] input terminal, first confirm the inverter is in the Stop Mode, and the motor is not rotating.

When the switch between the set terminals [SET] and [P24] is on, the inverter operates per the second set of parameters. When the terminal is turned off, the output function returns to the original settings (first set of motor parameters). Refer to the section on two-motor operation on page 4-34 for details.

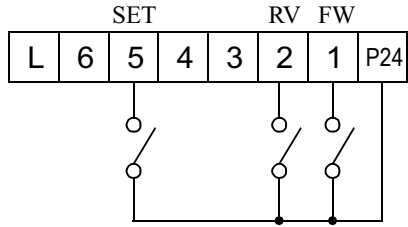
Option Code	Terminal Symbol	Function Name	Input State	Description
08	SET	Set 2nd Motor	ON	causes the inverter to use the 2nd set of motor parameters for generating the frequency output to motor
			OFF	causes the inverter to use the 1st (main) set of motor parameters for generating the frequency output to motor
Valid for inputs:		C01, C02, C03, C04, C05, C06		Example: 
Required settings:		(none)		
Notes:				
<ul style="list-style-type: none"> If the terminal is turned off while the motor is running, the inverter continues to generate the frequency output using the 2nd set of parameters until the motor is stopped. 				See I/O specs on page 4-5.

Two-stage Acceleration and Deceleration

When terminal [2CH] is turned on, the inverter changes the rate of acceleration and deceleration from the initial settings (F02 and F03) to use the second set of acceleration/ deceleration values. When the terminal is turned off, the equipment is returned to the original acceleration and deceleration time (F02 acceleration time 1, and F03 deceleration time 1). Use A92 (acceleration time 2) and A93 (deceleration time 2) to set the second stage acceleration and deceleration times.

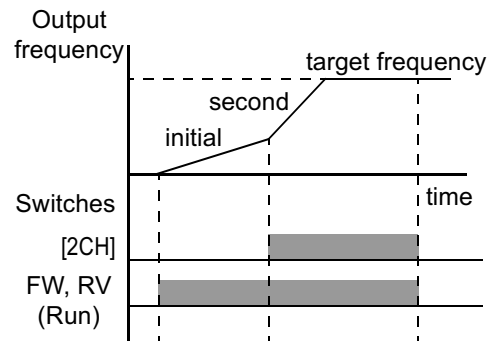

In the graph shown above, the [2CH] becomes active during the initial acceleration. This causes the inverter to switch from using acceleration 1 (F02) to acceleration 2 (A92).

Option Code	Terminal Symbol	Function Name	Input State	Description
09	2CH	Two-stage Acceleration and Deceleration	ON	Frequency output uses 2nd-stage acceleration and deceleration values
			OFF	Frequency output uses the initial acceleration 1 and deceleration 1 values
Valid for inputs:		C01, C02, C03, C04, C05, C06		Example:
Required settings:		A92, A93, A94=0		
Notes: <ul style="list-style-type: none"> Function A94 selects the method for second stage acceleration. It must be 00 to select the input terminal method in order for the 2CH terminal assignment to operate. 				
				See I/O specs on page 4-5.

Free-run Stop

When the terminal [FRS] is turned on, the inverter stops the output and the motor enters the free-run state (coasting). If terminal [FRS] is turned off, the output resumes sending power to the motor if the Run command is still active. The free-run stop feature works with other parameters to provide flexibility in stopping and starting motor rotation.

In the figure below, parameter B88 selects whether the inverter resumes operation from 0 Hz (left graph) or the current motor rotation speed (right graph) when the [FRS] terminal turns off. The application determines which is the best setting.

Parameter B03 specifies a delay time before resuming operation from a free-run stop. To disable this feature, use a zero delay time.

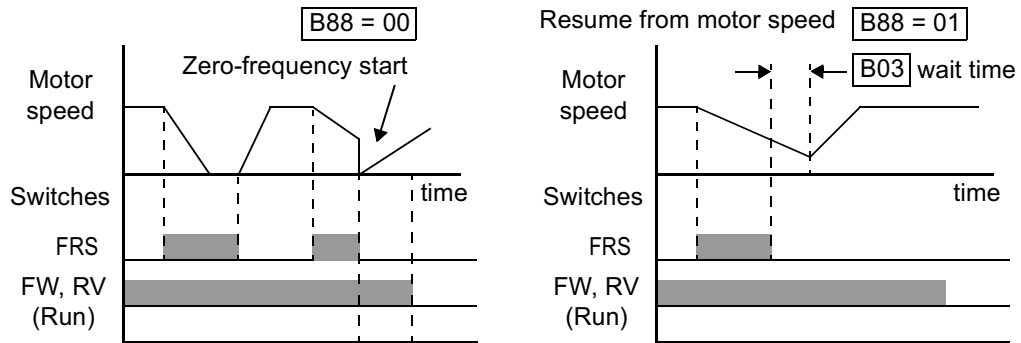

Option Code	Terminal Symbol	Function Name	Input State	Description
11	FRS	Free-run Stop	ON	Causes output to turn off, allowing motor to free run (coast) to stop
			OFF	Output operates normally, so controlled deceleration stops motor
Valid for inputs:		C01, C02, C03, C04, C05, C06		Example:
Required settings:		B03, B88, C11 to C16		
Notes:				
<ul style="list-style-type: none"> When you want the [FRS] terminal to be active low (normally closed logic), change the setting (C11 to C16) which corresponds to the input (C01 to C06) that is assigned the [FRS] function. 				See I/O specs on page 4-5.

External Trip

When the terminal [EXT] is turned on, the inverter enters the trip state, indicates error code E12, and stops the output. This is a general purpose interrupt type feature, and the meaning of the error depends on what you connect to the [EXT] terminal. When the switch between the set terminals [EXT] and [P24] is turned on, the equipment enters the trip state. Even when the switch to [EXT] is turned off, the inverter remains in the trip state. You must reset the inverter or cycle power to clear the error, returning the inverter to the Stop Mode.

In the graph below, the [EXT] input turns on during normal Run Mode operation. The inverter lets the motor free-run to a stop, and the alarm output turns on immediately. When the operator initiates a Reset command, the alarm and error are cleared. When the Reset is turned off, the motor begins rotation since the Run command is already active.

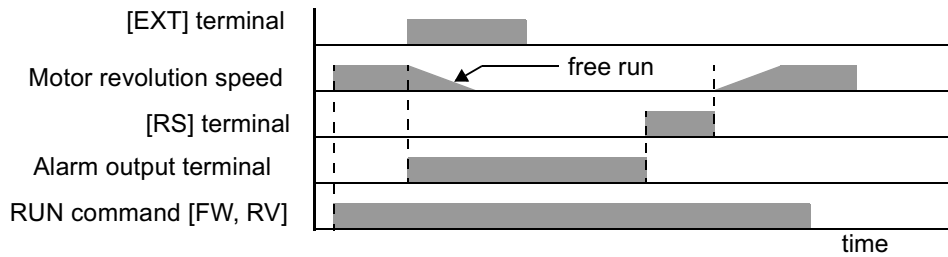

Option Code	Terminal Symbol	Function Name	Input State	Description
12	EXT	External Trip	ON	When assigned input transitions Off to On, inverter latches trip event and displays E12
			OFF	No trip event for On to Off, any recorded trip events remain in history until Reset
Valid for inputs:		C01, C02, C03, C04, C05, C06		Example:
Required settings:		(none)		
Notes:				
<ul style="list-style-type: none"> If the USP (Unattended Start Protection) feature is in use, the inverter will not automatically restart after cancelling the EXT trip event. In that case, it must receive another Run command (off-to-on transition). 				See I/O specs on page 4-5.

Operations and Monitoring

Unattended Start Protection

If the Run command is already set when power is turned on, the inverter starts running immediately after powerup. The Unattended Start Protection (USP) function prevents that automatic startup, so that the inverter *will not* run without outside intervention. To reset an alarm and restart running, turn the Run command off or perform a reset operation by the terminal [RS] input or the keypad Stop key.

In the figure below, the [UPS] feature is enabled. When the inverter power turns on, the motor does not start, even though the Run command is already active. Instead, it enters the USP trip state, and displays E13 error code. This forces outside intervention to reset the alarm by turning off the Run command. Then the Run command can turn on again and start the inverter output.

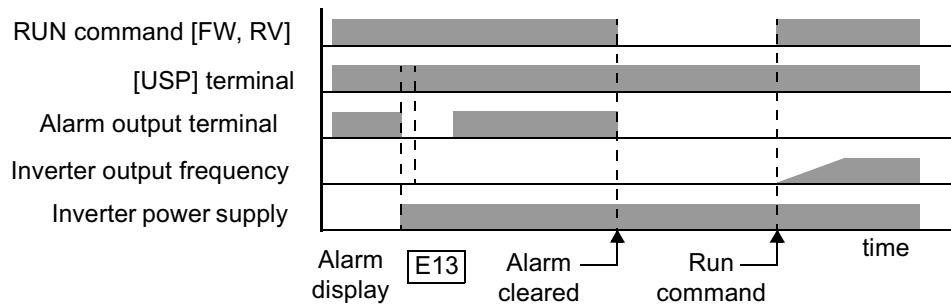

Option Code	Terminal Symbol	Function Name	Input State	Description
13	USP	Unattended Start Protection	ON	On powerup, the inverter will not resume a Run command (mostly used in the US)
			OFF	On powerup, the inverter will resume a Run command that was active before power loss
Valid for inputs:		C01, C02, C03, C04, C05, C06		Example:
Required settings:		(none)		
Notes:				
<ul style="list-style-type: none"> Note that when a USP error occurs and it is canceled by a reset from a [RS] terminal input, the inverter restarts running immediately. Even when the trip state is canceled by turning the terminal [RS] on and off after an under voltage protection E09 occurs, the USP function will be performed. When the running command is active immediately after the power is turned on, a USP error will occur. When this function is used, wait for at least three (3) seconds after the powerup to generate a Run command. 				See I/O specs on page 4-5.

Software Lock

When the terminal [SFT] is turned on, the data of all the parameters and functions except the output frequency is locked (prohibited from editing). When the data is locked, the keypad keys cannot edit inverter parameters. To edit parameters again, turn off the [SFT] terminal input.

Use parameter B31 to select whether the output frequency is excluded from the lock state or is locked as well.

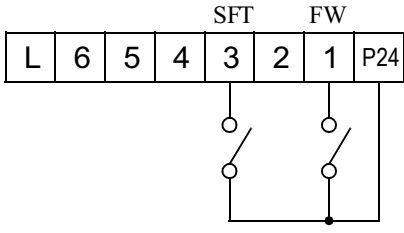
Option Code	Terminal Symbol	Function Name	Input State	Description
15	SFT	Software Lock	ON	The keypad and remote programming devices are prevented from changing parameters
			OFF	The parameters may be edited and stored
Valid for inputs:		C01, C02, C03, C04, C05, C06		Example: 
Required settings:		B31 (excluded from lock)		
Notes:				
<ul style="list-style-type: none"> • When the [SFT] terminal is turned on, only the output frequency can be changed. • Software lock can be made possible also for the output frequency by B31. • Software lock by the operator is also possible without the [SFT] terminal being used (B31). 				See I/O specs on page 4-5.

Analog Input Current/Voltage Select

The [AT] terminal selects whether the inverter uses the voltage [O] or current [OI] input terminals for external frequency control. When the switch between the terminals [AT] and [P24] is on, it is possible to set the output frequency by applying a current input signal at [OI]-[L]. When the terminal is turned off, the voltage input signal at [O]-[L] is available. Note that you must also set parameter A1 = 01 to enable the analog terminal set for controlling the inverter frequency.

Option Code	Terminal Symbol	Function Name	Input State	Description
16	AT	Analog Input Voltage/current Select	ON	Terminal OI is enabled for current input (uses terminal L for power supply return)
			OFF	Terminal O is enabled for voltage input (uses terminal L for power supply return)
Valid for inputs:		C01, C02, C03, C04, C05, C06		Example:
Required settings:		A01 = 01		
Notes:				
<ul style="list-style-type: none"> • If the [AT] option is not assigned to any intelligent input terminal, then inverter uses the algebraic sum of both the voltage and current inputs for the frequency command (and A01=01). • When using either the analog current and voltage input terminal, make sure that the [AT] function is allocated to an intelligent input terminal. • Be sure to set the frequency source setting A01=01 to select the analog input terminals. 				See I/O specs on page 4-5.

Reset Inverter

The [RS] terminal causes the inverter to execute the reset operation. If the inverter is in Trip Mode, the reset cancels the Trip state. When the switch between the set terminals [RS] and [P24] is turned on and off, the inverter executes the reset operation. The input timing requirement for [RST] needs a 12 ms pulse width or greater. The alarm output will be cleared within 30 ms after the onset of the Reset command.

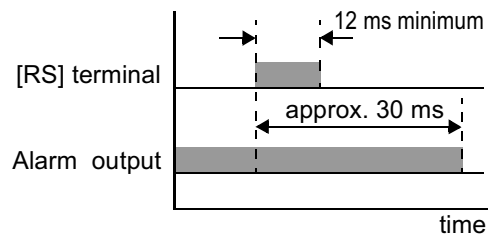

WARNING: After the Reset command is given and the alarm reset occurs, the motor will restart suddenly if the Run command is already active. Be sure to set the alarm reset after verifying that the Run command is off to prevent injury to personnel.

Option Code	Terminal Symbol	Function Name	Input State	Description
18	RS	Reset Inverter	ON	The motor output is turned off, the Trip Mode is cleared (if it exists), and powerup reset is applied
			OFF	Normal power-on operation
Valid for inputs:		C01, C02, C03, C04, C05, C06		Example:
Required settings:		(none)		
Notes:				
<ul style="list-style-type: none"> When the control terminal [RS] input is already On at powerup for more than 4 seconds, the remote operator display is “R-ERROR COMM<2>” (the display of the digital operator [OPE-J] is — — —. However, the inverter has no error. To clear the digital operator error, turn off the terminal [RS] input and press one of the operator keys. When the [RS] terminal is turned off from on, the Reset command is active. The Stop key’s reset function of the digital operator is valid only when an alarm occurs. Only the normally open contact can be set for a terminal configured with the [RS] function. The terminal cannot be used in the normally closed contact state. Even when power is turned off or on, the function of the terminal is the same as that of the reset terminal. The Stop key on the inverter is only operational for a few seconds after inverter powerup when a hand-held remote operator is connected to the inverter. If the [RS] terminal is turned on while the motor is running, the motor will be free running (coasting). 				

See I/O specs on page 4-5.

PTC Thermistor Thermal Protection

Motors that are equipped with a thermistor can be protected from overheating. Input terminal 5 has the unique ability to sense a thermistor voltage. When the resistance value of the thermistor connected to terminal [PTC] (5) and [L] is more than 3 k Ohms \pm 10%, the inverter enters the Trip Mode, turns off the output to the motor, and indicates the trip status E35. Use this function to protect the motor from overheating

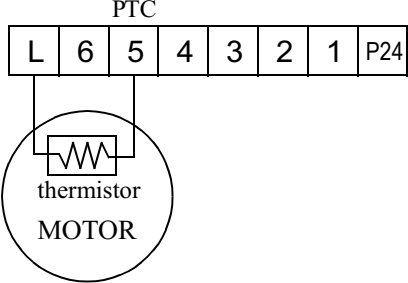
Option Code	Terminal Symbol	Function Name	Input State	Description
19	PTC	PTC Thermistor Thermal Protection	ANLG	When a thermistor is connected to terminals 5 and L, the inverter checks for over-temperature and will cause trip event and turn off output to motor
			OPEN	A disconnect of the thermistor causes a trip event, and the inverter turns off the motor
Valid for inputs:		C05 only		Example: 
Required settings:		(none)		
Notes:				
<ul style="list-style-type: none"> This function is assigned to the input terminal 5 only. If this function is assigned without connection the thermistor, the inverter automatically enters the Trip Mode. Be sure the thermistor is connected to terminals 5 and L, and then restart. 				

Remote Control Up and Down Functions

The [UP] [DWN] terminal functions can adjust the output frequency for remote control while the motor is running. The acceleration time and deceleration time of this function is same as normal operation ACC1 and DEC1 (2ACC1,2DEC1). The input terminals operate according to these principles:

- Acceleration - When the [UP] contact is turned On, the output frequency accelerates from the current value. When it is turned Off, the output frequency maintains its current value at that moment.
- Deceleration - When the [DWN] contact is turned On, the output frequency decelerates from the current value. When it is turned Off, the output frequency maintains its current value at that moment.

In the graph below, the [UP] and [DWN] terminals activate while the Run command remains On. The output frequency responds to the [UP] and [DWN] commands.

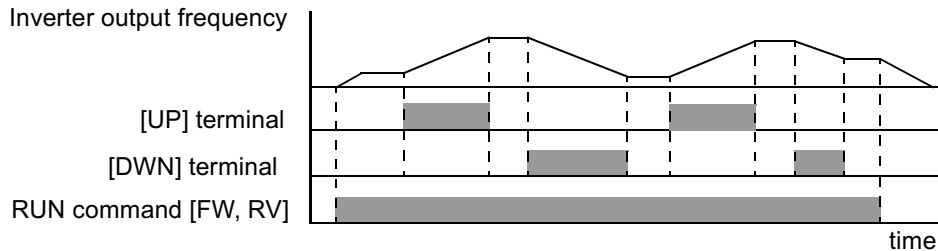

Option Code	Terminal Symbol	Function Name	Input State	Description
27	UP	Remote Control UP Function	ON	Accelerates (increases output frequency) motor from current frequency
			OFF	Output to motor operates normally
28	DWN	Remote Control DOWN Function	ON	Decelerates (decreases output frequency) motor from current frequency
			OFF	Output to motor operates normally
Valid for inputs:		C01, C02, C03, C04, C05, C06		Example:
Required settings:		A01 = 02		
Notes:				
<ul style="list-style-type: none"> • This feature is available only when the frequency command source is programmed for operator control. Confirm A01 is set to 02. • This function is not available when [JG] is in use. • The range of output frequency is 0 Hz to the value in A04 (maximum frequency setting). • The minimum ON time of [UP] and [DWN] is 50 ms. • This setting modifies the inverter speed from using F01 output frequency setting as a starting point. 				See I/O specs on page 4-5.

Operations and Monitoring

Using Intelligent Output Terminals

The intelligent output terminals are programmable in a similar way to the intelligent input terminals. The inverter has several output functions which you can assign individually to three physical logic outputs. Two of the outputs are open-collector transistors, and the third output is the alarm relay (form C – normally open and normally closed contacts). The relay is assigned the alarm function by default, but you can assign it to any of the functions that the open-collector outputs can use as well.

Run Signal

When the [RUN] signal is selected as an intelligent output terminal, the inverter outputs a signal on that terminal when it is in the Run Mode. The output logic is active low, and is the open collector type (switch to ground).

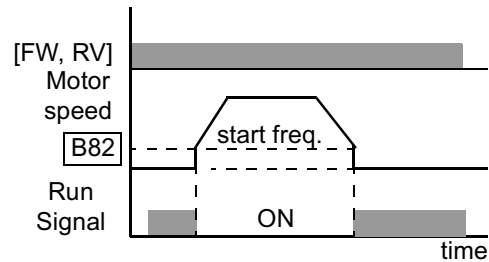

Option Code	Terminal Symbol	Function Name	Output State	Description
00	RUN	Run signal	ON	when inverter is in Run Mode
			OFF	when inverter is in Stop Mode
Valid for outputs:		11, 12, AL0 – AL2		Example:
Required settings:		(none)		
Notes:				
<ul style="list-style-type: none"> The inverter outputs the [RUN] signal whenever the inverter output exceeds the start frequency specified by parameter B82. The start frequency is the initial inverter output frequency when it turns on. 				See I/O specs on page 4-5.



NOTE: The example circuit in the table above drives a relay coil. Note the use of a diode to prevent the negative-going turn-off spike generated by the coil from damaging the inverter’s output transistor.

Frequency Arrival Signal

Frequency Arrival [FA1] and [FA2] signals indicate when the output frequency accelerates or decelerates to arrive at a constant frequency. Refer to the figure below. Frequency Arrival [FA1] (left graph) turns on when the output frequency gets within 0.5 Hz below or 1.5 Hz above the target constant frequency. The timing is modified by a small 60 ms delay. Note the active low nature of the signal, due to the open collector output.

Frequency Arrival [FA2] (right graph) uses thresholds for acceleration and deceleration to provide more timing flexibility than [FA1]. Parameter C42 sets the arrival frequency threshold for acceleration, and parameter C43 sets the threshold for deceleration. This signal also is active low and has a 60 ms delay after the frequency thresholds are crossed.

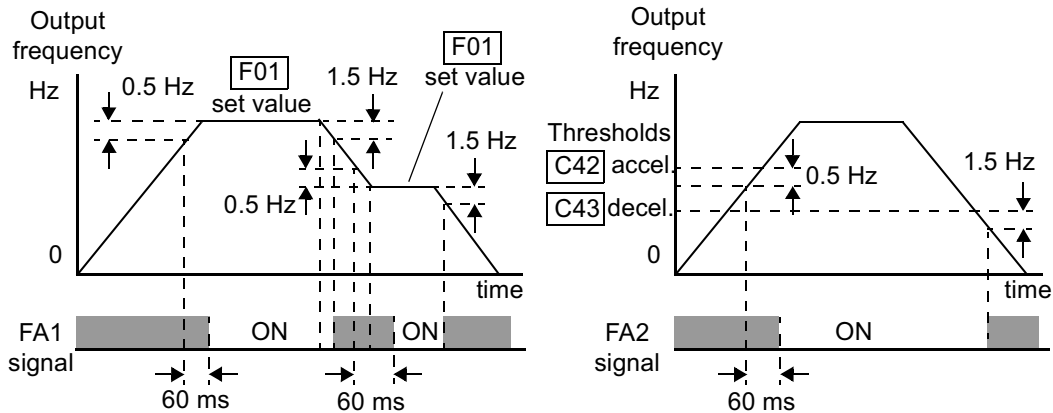

Option Code	Terminal Symbol	Function Name	Output State	Description
01	FA1	Frequency arrival type 1 signal	ON	when output to motor is at the set frequency
			OFF	when output to motor is off, or in any acceleration or deceleration ramp
02	FA2	Frequency arrival type 2 signal	ON	when output to motor is at or above the set frequency thresholds for, even if in acceleration or deceleration ramps
			OFF	when output to motor is off, or during acceleration or deceleration before the respective thresholds are crossed
Valid for outputs:		11, 12, AL0 – AL2		Example: See I/O specs on page 4-5.
Required settings:		(none)		
Notes: <ul style="list-style-type: none"> At the time of acceleration, an output signal at a frequency between the set frequency - 0.5 Hz to + 1.5 Hz is turned on. At the time of deceleration, an output signal at a frequency between the set frequency + 0.5 Hz to -1.5 Hz is turned on. The delay time of the output signal is 60 ms (nominal). 				

Operations and Monitoring

Overload Advance Notice Signal

When the output current exceeds a preset value, the [OL] terminal signal turns on. The parameter C41 sets the overload threshold. The overload detection circuit operates during powered motor operation and during regenerative braking. The output circuits use open-collector transistors, and are active low.

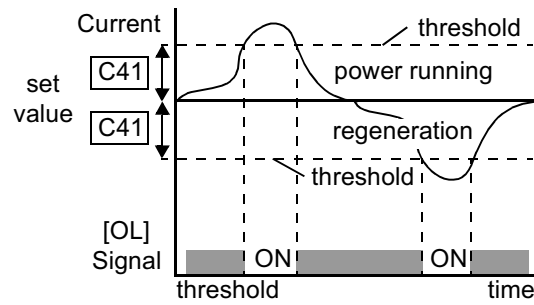

Option Code	Terminal Symbol	Function Name	Output State	Description
03	OL	Overload advance notice signal	ON	when output current is more than the set threshold for the overload signal
			OFF	when output current is less than the set threshold for the overload signal
Valid for outputs:		11, 12, AL0 – AL2		Example:
Required settings:		C41		
Notes:				
<ul style="list-style-type: none"> The default value is 100%. To change the level from the default, set C41 (overload level). The accuracy of this function is the same as the function of the output current monitor on the [FM] terminal (see page 4-28). 				See I/O specs on page 4-5.



NOTE: The example circuit in the table above drives a relay coil. Note the use of a diode to prevent the negative-going turn-off spike generated by the coil from damaging the inverter’s output transistor.

Output Deviation for PID Control

The PID loop error is defined as the magnitude (absolute value) of the difference between the Setpoint (target value) and the Process Variable (actual value). When the error magnitude exceeds the preset value for C44, the [OD] terminal signal turns on. Refer to the PID loop section on page 4-33 for more on PID loop operation.

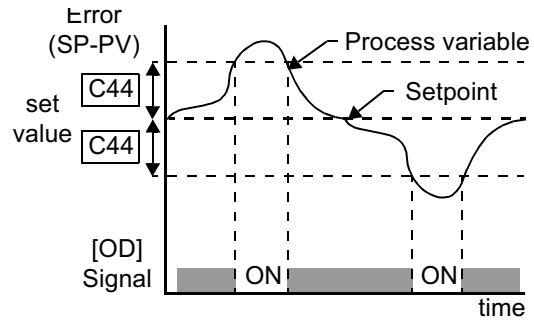

Option Code	Terminal Symbol	Function Name	Output State	Description
04	OD	Output deviation for PID control	ON	when PID error is more than the set threshold for the deviation signal
			OFF	when PID error is less than the set threshold for the deviation signal
Valid for outputs:		11, 12, AL0 – AL2		Example:
Required settings:		C44		
Notes: <ul style="list-style-type: none"> The default difference value is set to 3%. To change this value, change parameter C44 (deviation level). 				

See I/O specs on page 4-5.



NOTE: The example circuit in the table above drives a relay coil. Note the use of a diode to prevent the negative-going turn-off spike generated by the coil from damaging the inverter's output transistor.

Alarm Signal

The inverter alarm signal is active when a fault has occurred and it is in the Trip Mode (refer to the diagram at right). When the fault is cleared the alarm signal becomes inactive.

We must make a distinction between the alarm signal [AL] and the alarm relay contacts AL0, AL1 and AL2. The signal [AL] is a logic function which you can assign to the open collector output terminals 11, or 12, or the relay outputs. The most common (and default) use of the relay is for [AL], thus the labeling of its terminals. Use an open collector output (terminal 11 or 12) for a low-current logic signal interface or to energize a small relay (50 mA maximum). Use the relay output to interface to higher voltage and current devices (10 mA minimum).

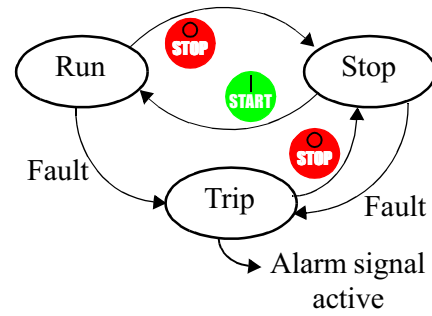

Option Code	Terminal Symbol	Function Name	Output State	Description
05	AL	Alarm signal	ON	when an alarm signal has occurred and has not been cleared
			OFF	when no alarm has occurred since the last clearing of alarm(s)
Valid for outputs:		11, 12, AL0 – AL2		Example for terminal 11 or 12:
Required settings:		C24, C33		
Notes: <ul style="list-style-type: none"> When the alarm output is set to normally closed, a time delay occurs until the contact is closed when the power is turned on. Therefore, when the alarm contact output is to be used, set a delay of about 2 seconds when the power is turned on. Terminals 11 and 12 are open collector outputs, so the electric specification of [AL] is different from the contact output terminals AL0, AL1, AL2. The logic sequence of terminals 11 and 12 is the same as AL0-AL2. See the description of AL1, AL2, and AL0. When the inverter power supply is turned off, the alarm signal output is valid as long as the external control circuit has power. This signal output has the delay time (300ms nominal) from the fault alarm output. 				
Example for terminals AL0, AL1, AL2: <p>Relay position shown is during normal running (no alarm).</p> <p>See I/O specs on page 4-5.</p>				

Operations and Monitoring



NOTE: The relay contact specifications are in the connector input/output specifications on page 4-5. The contact diagrams for different conditions are on the next page.

The alarm output terminals are connected as shown below (left) by default, or after initialization. The contact logic can be inverted as shown (below right) by using the parameter setting C33. The relay contacts normally open (N.O.) and normally closed (N.O.) convention uses “normal” to mean the inverter has power and is in Run or Stop Mode. The relay contacts switch to the opposite position when it is in Trip Mode or when input power is Off.

N.C. contacts (after initialization)					N.O. contact (inverted by C33 setting)				
During normal running		When an alarm occurs or power is turned off			During normal running or power is turned off		When an alarm occurs		
Contact	Power	Run State	AL0-AL1	AL0-AL2	Contact	Power	Run State	AL0-AL1	AL0-AL2
N.C. (after initialize, C33=01)	ON	Normal	Closed	Open	N.O. (set C33=00)	ON	Normal	Open	Closed
	ON	Trip	Open	Closed		ON	Trip	Closed	Open
	OFF	–	Open	Closed		OFF	–	Open	Closed

Analog Input Operation

The AF91sv inverters provide for analog input to command the inverter frequency output value. The analog input terminal group includes the L, OI, O, and H terminals on the control connector, which provide for Voltage [O] or Current [OI] input. All analog input signals must use the analog ground [L].

If you use either the voltage or current analog input, you must select one of them using the logic input terminal function [AT] analog type. If terminal [AT] is Off, the voltage input [O] can command the inverter output frequency. If terminal [AT] is On, the current input [OI] can command the inverter output frequency. The [AT] terminal function is covered in the logic input section on page 4-17. Remember that you must also set A01 = 01 to select analog input as the frequency source.

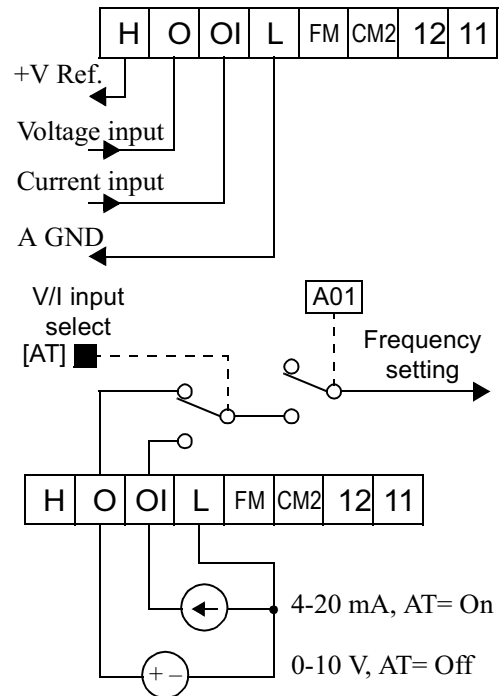

NOTE: If no logic input terminal is configured for the [AT] function, then inverter sums the voltage and current input to determine the desired input value.

Using an external potentiometer is a popular way to control the inverter output frequency (and a good way to learn how to use the analog inputs). The potentiometer uses the 10V reference [H] and the analog ground [L] for excitation, and the voltage input for the signal. By default, the [AT] terminal selects the voltage input when it is Off. Take care to use the proper resistance for the potentiometer, which is 1 to 2 k Ohms, 2 Watts.

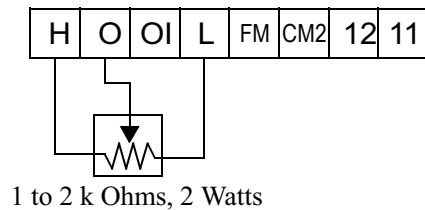

Voltage Input – The voltage input circuit uses terminals [L] and [O]. Attach the cable shield wire only to terminal [L] on the inverter. Maintain the voltage within specifications (do not apply negative voltage).

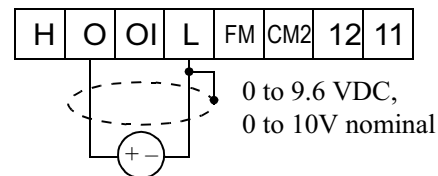

Current Input – The current input circuit uses terminals [OI] and [L]. The current come from a *sourcing* type transmitter; a *sinking* type will not work! This means the current must flow into terminal [OI], and terminal [L] is the return back to the transmitter. The input impedance from [OI] to [L] is 250 Ohms. Attach the cable shield wire only to terminal [L] on the inverter.

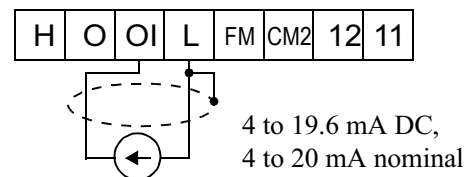

See I/O specs on page 4-5.

Analog and Digital Monitor Output

In the system design for the inverter application, it is useful to monitor the inverter operation from a remote location. In some cases, this is only a panel-mounted analog meter (moving-coil type). In other cases, a controller device such as a PLC may command the inverter frequency and other functions. Sometimes it is useful to have the inverter transmit the (real-time) output frequency value back to the controller to confirm actual operation. The analog output function serves these purposes.

The inverter provides an analog/digital output terminal primarily for frequency monitoring on terminal [FM] (frequency monitor). It uses terminal [L] as analog GND reference. If needed, you can configure terminal [FM] to transmit the inverter current output value instead.

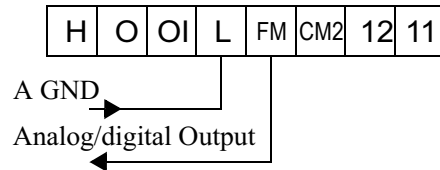

See I/O specs on page 4-5.

Parameter C23 selects the output signal data and transmission format. The selections are:

- C23 = 00 Analog monitor output frequency, pulse-width modulated (PWM) format
- C23 = 01 Analog monitor output current, pulse-width modulated (PWM) format
- C23 = 02 Digital monitor output frequency, frequency-modulated format

The analog PWM signals are primarily designed for driving a moving-coil meter. The pulse-width modulated signal is automatically averaged by the inertia of the moving-coil mechanism. The meter's indicator needle mechanically converts the PWM signal to an analog representation. Be sure to use a 10V full-scale DC voltmeter.

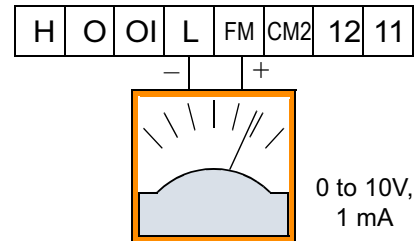

The signal characteristics of [FM] for each of the output formats are shown below:

Pulse-width modulation (analog)

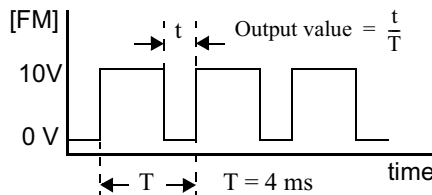

- C23 = 00 Inverter output frequency
- C23 = 01 Inverter output current
- B81 PWM scale factor

Frequency Monitor, PWM Signal – (C23 = 00) The [FM] output duty cycle varies with the inverter output frequency. The signal period T is fixed at 4 ms, and the amplitude is fixed at 10 VDC. The signal on [FM] reaches full scale when the inverter outputs the maximum frequency. You can scale the duty cycle with a scale factor setting with parameter B81. This is a dedicated indicator, so that it cannot be used as a line speed signal.



NOTE: The indicator accuracy after adjustment is about $\pm 5\%$. Depending on the motor, the accuracy may exceed this value.

Current Monitor, PWM Signal – (C23 = 01) – The [FM] output duty cycle varies with the inverter output current to the motor. The signal period T is fixed at 4 ms, and the amplitude is fixed at 10 VDC. The signal on [FM] reaches full scale when the inverter output current reaches 200% of the rated inverter current. You can scale the duty cycle by a scale factor setting with parameter B81. The accuracy of the current reading is given by the equation:

$$\frac{I_{mc} - I_m}{I_r} \times 100 \leq \pm 20\%$$

I_m = Inverter output current (measured)
 I_{mc} = Monitor display current
 I_r = Inverter rated current



NOTE: The monitor display accuracy (normally $\pm 20\%$, depending on the connected motor's characteristics) can be improved by the adjustment of parameter B32. If precise current measurement is necessary, use the moving-coil type ammeter between the inverter and the motor.



TIP: When using the analog meter for monitoring, adjust the meter so it has a zero reading when the [FM] output is zero. Then use scale factor B81 to adjust the [FM] output so the maximum frequency in the inverter corresponds to a full-scale reading on the meter.

PWM Smoothing Circuit – You may need to smooth the PWM signal, converting it to a relatively stable DC analog voltage which represents the [FM] output value. To do this, use the circuit shown to the right. Note the output impedance of the circuit is at least 82k Ohms, so the monitoring device needs an input impedance of 1 Meg. Ohms or greater. Otherwise, the impedance of the smoothing circuit will cause a non-linearity in the reading.

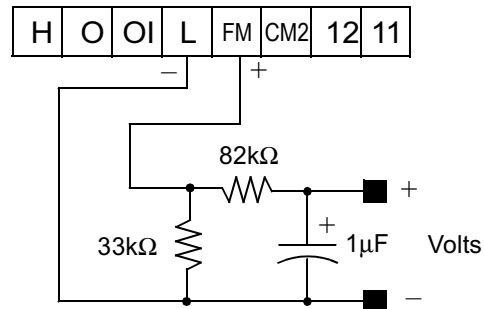

See I/O specs on page 4-5.

Frequency Monitor, FM Signal – (C23 = 02) – The [FM] output frequency varies with the inverter output frequency. The maximum frequency of [FM] is 3.6 kHz, or 10 times the inverter maximum frequency. The signal on [FM] reaches the maximum frequency when the inverter outputs the maximum frequency. You can scale its relationship to the inverter output with the scale factor setting with parameter B86.

Frequency modulation (digital)

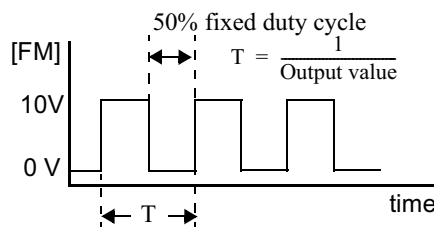

C23 = 02 Inverter output frequency
B86 Freq. scale factor

Auto-tuning for Sensorless Vector Control

The AF91sv inverter has a built-in auto-tuning algorithm. Its purpose is to detect and record the motor parameters to use in sensorless vector control. As you may recall from Chapter 3, sensorless vector control (SLV) is the more sophisticated control algorithm the AF91sv inverter can use to deliver higher torque levels at different speeds. Using parameter A44, you can select from the following:

- 00 = Adjustable frequency with constant torque
- 01 = Adjustable frequency with reduced torque
- 02 = Sensorless vector control (SLV)



NOTE: Although “auto-tuning” is often associated with PID loops, the PID loop in the AF91sv inverter is not directly affected by the auto-tuning procedure or parameters.

Most of the “H” Group parameters are dedicated to storing SLV parameters. The inverter comes from the factory with default settings for these parameters. To benefit fully from SLV control, you must use A44 to select SLV control, and initiate the auto-tuning calibration procedure as described below for your motor. During the procedure, the inverter will write new values for the “H” Group settings related to SLV control. The settings have a second set of parameters for a second motor. The factory default configuration will apply auto-tuning to the first motor.



WARNING: You may need to disconnect the load from the motor before performing auto-tuning. The inverter runs the motor forward and backward for several seconds without regard to load movement limits.

Follow the steps below to auto-tune the inverter (table continued on next page):

Step	Parameter		Parameter Setting or Action	Notes
	Code	Name		
1	F02	Acceleration time	Set to a time greater than 10 seconds	Parameters F02 and F03 must be equal in order for the moment of inertia data to be correct. Increase the time if over-current or over-voltage trip event occurs.
2	F03	Deceleration time	Set the same as setting F02	
3	H03	Motor capacity	Varies with inverter (default value will be correct)	Setting is in kW
4	H04	Motor pole count	Set the poles 2 / 4 / 6 / 8 to match motor	Refer to the motor specifications label
5	A01	Frequency command source	Set = 02 (selects parameter F01 as source of output frequency)	The auto-tuning procedure will automatically control the speed
6	A03	Base frequency	Set = 50 or 60 for your motor	Default= 50 (Europe) / 60(US)
7	A20	Multi-speed 0 setting	Set A20 > 0	If A20 = 0, auto-tuning is not performed

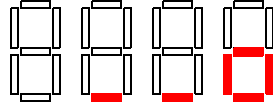
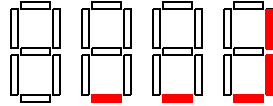
Step	Parameter		Parameter Setting or Action	Notes
	Code	Name		
8	A82	AVR voltage select	Select output voltage for motor 200V class: 200/220/230/240 400V class: 380/400/415/440/ 460	Voltage setting cannot be greater than input voltage
9	A51	DC braking enable	Set = 00 to disable DC braking	Default = 00 (disabled)
10	H01	Auto-tuning Setting	Set = 01 (full auto-tuning Set = 02 (partial auto-tuning – measures resistance and inductance only)	Try using H01 = 01, if possible. If application or load interferes with or prohibits motor rotation, then use H01 = 02.
11	—	—	Press the Start key on the keypad and wait for the test to complete	The inverter actions are: A) .. AC excitation (no rotation) B) .. DC excitation (no rotation) C) .. Motor accelerates to 80% of base frequency, then stops. D) Motor accelerates to A20 setting frequency, then stops.
12	—	—	Interpret results by reading the display pattern	Auto-tuning process completed steps A) to D)  Auto-tuning failed at step A) or B) 
13	—	—	Reset Inverter by pressing the Stop Key	Inverter will display alternating pattern on the display and return to parameter menu. Auto-tuning will be off. Make any corrections and start again at step 10.



NOTE: During step 11, the motor will make a slight humming sound during the AC and DC excitation (A and B) steps of the auto-tuning process. This sound is normal.



NOTE: When the SLV control method is selected with A44 (F-04), set the carrier frequency to 2.1 kHz or higher with B83 (F-36).

If the inverter drives a motor/load with a small inertia, the motor may exhibit “hunting” during running. If this occurs, take the following corrective steps:

1. Adjust the stabilization constant H06/H206 (F-05).
2. Decrease the carrier frequency B83 (F-36), but not below 2.1 kHz.
3. Set the Automatic Voltage Regulation (AVR) function A81 (F-03) to the Off setting (disabled = 01).

If the desired characteristic cannot be obtained in sensorless vector controlled operation with standard (factory default) or auto-tuning data, adjust the motor constant(s) according to the observed symptoms shown below.

Operation Status	Symptom	Adjustment	Parameter
Powered running (status with an accelerating torque)	When low frequency (a few Hz) torque is insufficient	Increase the motor speed constant R1 in relation to auto-tuning data, step by step, within 1 to 1.2 times R2.	H20 / H30 / H220/ H230
	When the speed fluctuation coefficient becomes negative	Increase the motor constant R2 in relation to auto-tuning data, step by step, within 1 to 1.2 times R2.	H21 / H32 / H221 / H231
	When the speed fluctuation coefficient becomes positive	Decrease the motor constant R2 in relation to auto-tuning data, step by step, within 0.8 to 1 times R2.	H21 / H32 / H221 / H231
Regeneration (status with a decelerating torque)	When low frequency (a few Hz) torque is insufficient	Increase the motor speed constant R1 in relation to auto-tuning data, step by step, within 1 to 1.2 times R1.	H20 / H30 / H220/ H230
		Increase the motor constant R2 in relation to auto-tuning data, step by step, within 1 to 1.2 times R2.	H21 / H32 / H221 / H231
		Decrease the carrier frequency set value.	B83

- Note 1:** If the inverter is using sensorless vector control and the motor is more than one frame size smaller than the maximum applicable motor, then the motor characteristic values may not be satisfactory.
- Note 2:** No sensorless vector control operation is possible if two or more motors are connected (parallel operation).
- Note 3:** When the auto-tuning function is executed in the state that the DC braking is set, the motor constants will not be accurately set. Therefore, disable DC braking and then start the auto-tuning procedure again.
- Note 4:** When accelerating or speeding up is not to be performed in the auto-tuning step for accelerating up to 80% of the base frequency, lower the set value of manual torque boost.
- Note 5:** Be sure the motor is stopped before you carry out an auto-tuning procedure. Auto-tuning data which is derived while the motor is still running may not be correct.
- Note 6:** Do not interrupt an auto-tuning procedure by removing power or by using the Stop command, unless it is emergency. If this does occur, initialize the inverter's parameters to the factory default settings (see page 6-8). Then reprogram the parameters unique to your application, and initiate the auto-tuning procedure again.



NOTE: When the data of the H Group parameters does not match that of the motor, satisfactory characteristics may not be obtained during sensorless vector operation. Also, the stabilization adjustment (H06) is effective for V/F settings (00 and 01). The full performance may not be achieved if the rating of a motor used is more than one frame size smaller than the maximum applicable rating when the sensorless vector function is used. You must disable sensorless vector operation when two or more motors are connected. For the motor stabilization, set this data properly for the H03 (H203) parameter according to the motor used if its rating is not the same as the maximum applicable rating in V/F operation.

PID Loop Operation

In standard operation, the inverter uses a reference source selected by parameter A01 for the output frequency, which may be a fixed value (F01), a variable set by the front panel potentiometer, or value from an analog input (voltage or current). To enable PID operation, set A71 = 01. This causes the inverter to *calculate* the target frequency, or setpoint.

A calculated target frequency can have a lot of advantages. It lets the inverter adjust the motor speed to optimize some other process of interest, while saving energy as well. Refer to the figure below. The motor has some eventual effect on the process. To control the external process, the inverter must monitor the process variable. This requires wiring a sensor to either the analog input terminal O (voltage) or terminal OI (current).

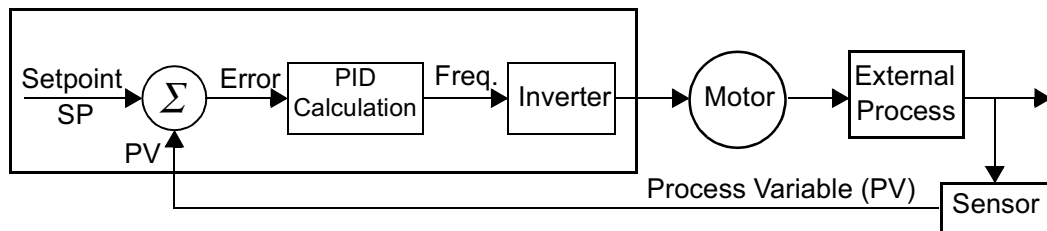

When enabled, the PID loop calculates the ideal output frequency to minimize the loop error. This means we no longer command the inverter to run at a particular frequency, but we specify the ideal value for the process variable. That ideal value is called the *setpoint*, and is specified in the units of the external process variable. For a pump application it may be gallons/minute, or it could be air velocity or temperature for an HVAC unit. Parameter A75 is a scale factor that relates the external process variable units to motor frequency. The figure below is a more detailed diagram of the PID function.

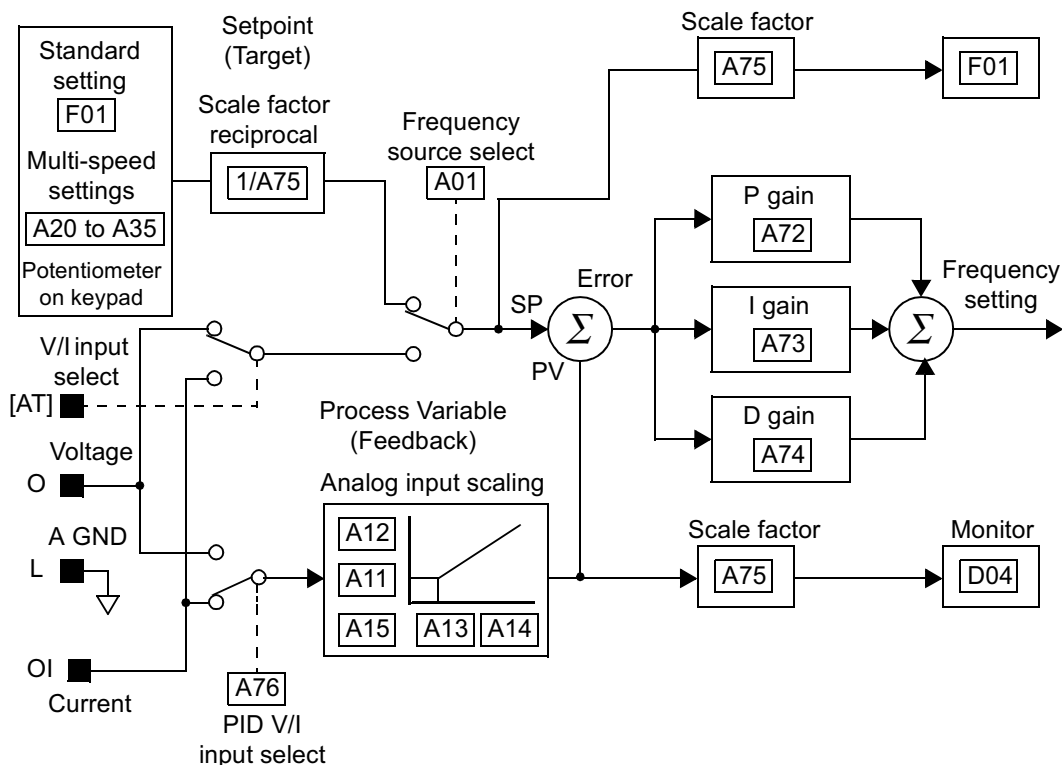

Operations and Monitoring

Configuring the Inverter for Multiple Motors

Simultaneous Connections

For some applications, you may need to connect two or more motors (wired in parallel) to a single inverter's output. For example, this is common in conveyor applications where two separate conveyors need to have approximately the same speed. The use of two motors may be less expensive than making the mechanical link for one motor to drive multiple conveyors.

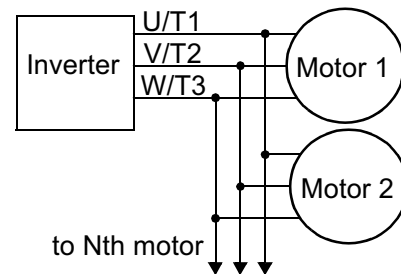

Some of the characteristics of using multiple motors with one drive are:

- Use only V/F (variable-frequency) control; do not use SLV (sensorless vector control).
- The inverter output must be rated to handle the sum of the currents from the motors.
- You must use separate thermal protection switches or devices to protect each motor. Locate the device for each motor inside the motor housing or as close to it as possible.
- The wiring for the motors must be permanently connected in parallel (do not remove one motor from the circuit during operation).



NOTE: The motor speeds are identical only in theory. That is because slight differences in their loads will cause one motor to slip a little more than another, even if the motors are identical. Therefore, do not use this technique for multi-axis machinery that must maintain a fixed position reference between its axes.

Inverter Configuration for Two Motor Types

Some equipment manufacturers may have a single type of machine that has to support two different motor types — and only one motor will be connected at a time. For example, an OEM may sell basically the same machine to the US market and the European market. Some reasons why the OEM needs two motor profiles are:

- The inverter power input voltage is different for these markets.
- The required motor type is also different for each destination.

In other cases, the inverter needs two profiles because the machine characteristics vary according to these situations:

- Sometimes the motor load is very light and can move fast. Other times the motor load is heavy and must move slower. Using two profiles allows the motor speed, acceleration and deceleration to be optimal for the load and avoid inverter trip (fault) events.
- Sometimes the slower version of the machine does not have special braking options, but a higher performance version does have braking features.

Having two motor profiles lets you store two “personalities” for motors in one inverter’s memory. The inverter allows the final selection between the two motor types to be made in the field through the use of an intelligent input terminal function [SET]. This provides an extra level of flexibility needed in particular situations. See the following page.

Parameters for the second motor have a function code of the form x2xx. They appear immediately after the first motor's parameter in the menu listing order. The following table lists the parameters which have the second parameter register for programming.

Function Name	Parameter Codes	
	1st motor	2nd motor
Multi-speed frequency setting	A20	A220
Acceleration time setting (Acceleration 1)	F02	F202
Deceleration time setting (Deceleration 1)	F03	F203
Second acceleration time setting (Acceleration 2)	A92	A292
Second deceleration time setting (Deceleration 2)	A93	A293
Select method to use 2nd acceleration/deceleration	A94	A294
Acc1 to Acc2 frequency transition point	A95	A295
Dec1 to Dec2 frequency transition point	A96	A296
Level of electronic thermal setting	B12	B212
Select electronic thermal characteristic	B13	B213
Torque boost method selection	A41	A241
Manual torque boost value	A42	A242
Manual torque boost frequency adjustment	A43	A243
V/F characteristic curve selection	A44	A244
Base frequency setting	A03	A203
Maximum frequency setting	A04	A204
Select motor constant	H02	H202
Motor capacity setting	H03	H203
Motor poles setting	H04	H204
Motor constant R1 setting (Standard, Auto tuning)	H20/H30	H220/H230
Motor constant R2 setting (Standard, Auto tuning)	H21/H31	H221/H231
Motor constant L setting (Standard, Auto tuning)	H22/H32	H222/H232
Motor constant Io setting (Standard, Auto tuning)	H23/H33	H223/H233
Motor constant J setting (Standard, Auto tuning)	H24/H34	H224/H234
Motor constant Kp setting (Standard, Auto tuning)	H05	H205
Motor stabilization constant	H06	H206

Motor Control Accessories



In This Chapter....	page
— Introduction	2
— Component Descriptions	3

Introduction

A motor control system will obviously include a motor and inverter, as well as fuses for safety. If you are connecting a motor to the inverter on a test bench just to get started, that's all you may need for now. But a fully developed system can also have a variety of additional components. Some can be for noise suppression, while others may enhance the inverter's braking performance. The figure below shows a system with several possible optional components, and the table gives part number information.

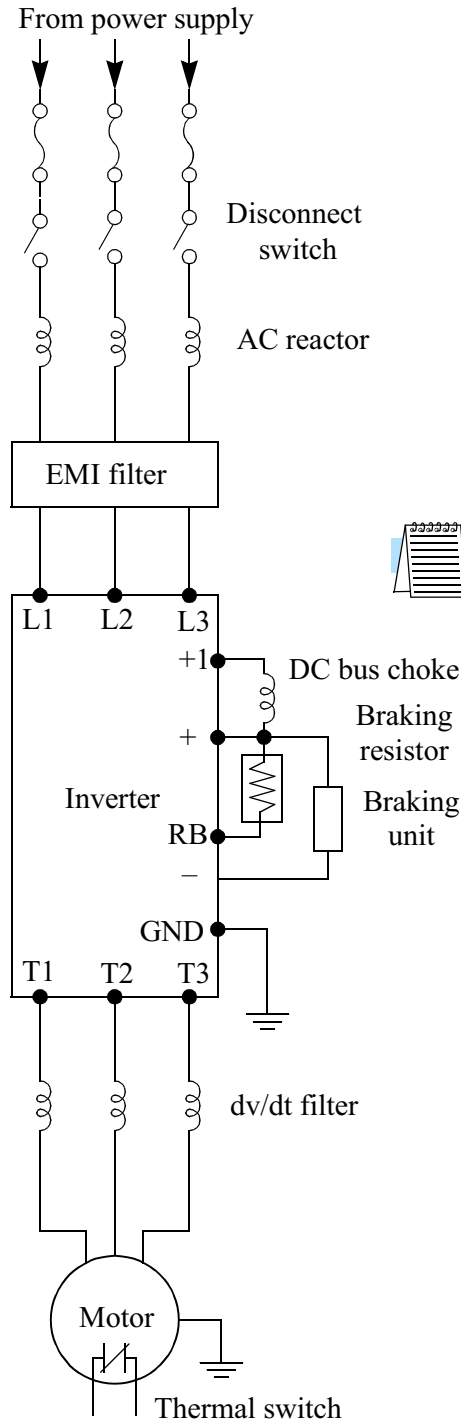

Name	Part No.	See page
AC reactor, input side	K64-0009xx-xxxx	3
EMI filter (for CE)	K13-000034-010x	4
DC bus choke	K64-00105x-xxxx	4
Braking resistor	K13-000034-07xx	5
dv/dt filter, output side	K64-0009xx-xxxx	3



NOTE: The Cutler-Hammer part number series for accessories includes different sizes of each part type, specified by the -x suffix. Cutler-Hammer product literature can help match size and rating of your inverter to the proper accessory size.

Each inverter accessory comes with its own printed instruction manual. Please refer to those manuals for complete installation details. This chapter gives only an overview of these optional system devices.

Component Descriptions

AC Reactors, Input Side

This is useful in suppressing harmonics induced on the power supply lines, or when the main power voltage imbalance exceeds 3% (and power source capacity is more than 500 kVA), or to smooth out line fluctuations. It also improves the power factor.

In the following cases for a general-purpose inverter, a large peak current flows on the main power supply side, and is able to destroy the inverter module:

- If the unbalanced factor of the power supply is 3% or higher
- If the power supply capacity is at least 10 times greater than the inverter capacity (the power supply capacity is 500 kVA or more)
- If abrupt power supply changes are expected

Examples of these situations include:

1. Several inverters are interconnected (input side) with a short bus.
2. A thyristor converter and an inverter are interconnected (input side) with a short bus.
3. An installed phase advance capacitor opens and closes.

Where these conditions exist or when the connected equipment must be highly reliable, install an AC reactor between the power supply and the inverter. Also, where the effects of an indirect lightning strike is possible, install a lightning conductor.

Example calculation:

$$V_{RS} = 205V, V_{ST} = 203V, V_{TR} = 197V,$$

where V_{RS} is R-S line voltage, V_{ST} is S-T line voltage, V_{TR} is T-R line voltage

$$\text{Unbalance factor of voltage} = \frac{\text{Max. line voltage (min.)} - \text{Mean line voltage}}{\text{Meanline voltage}} \times 100$$

$$= \frac{V_{RS} - (V_{RS} + V_{ST} + V_{TR})/3}{(V_{RS} + V_{ST} + V_{TR})/3} \times 100 = \frac{205 - 202}{202} \times 100 = 1.5\%$$

Please refer to the documentation that comes with the AC reactor for installation instructions.

DV/DT Filter, Output Side

This filter reduces the vibrations in the motor caused by the inverter's switching waveforms by smoothing the waveforms to approximate commercial power quality. It is also useful when wiring from the inverter to the motor is more than 10m in length, reducing reflected voltage wave phenomenon. Please refer to the documentation that comes with the dv/dt filter for installation instructions.

EMI Filter

The EMI filter reduces the conducted noise on the power supply wiring generated by the main power supply, protecting the inverter. Connect the EMI filter to the inverter primary (input side). The FFL100 series filter is required for compliance to the EMC directive (Europe) and C-TICK (Australia). The other filters are not for this purpose.



WARNING: The EMI filter has high internal leakage current from power wiring to the chassis. Therefore, connect the chassis ground of the EMI filter before making the power connections to avoid danger of shock or injury.



EMI Filter

DC Bus Choke

The DC choke (reactor) suppresses harmonics generated by the inverter. It attenuates the high-frequency components on the inverter's internal DC bus (link). However, note that it does not protect the diode rectifiers in the inverter input circuit.

Dynamic Braking

The purpose of dynamic braking is to improve the ability of the inverter to stop (decelerate) the motor and load. This becomes necessary when an application has some or all of the following factors:

- High load inertia compared to the available motor torque
- The application requires frequent or sudden changes in speed
- System losses are not great enough to slow the motor as needed

When the inverter slows its output frequency to decelerate the load, the motor can temporarily become a generator. This occurs when the motor rotation develops a voltage higher than the inverter internal (DC) bus voltage. This condition can cause the inverter to have an over-voltage fault and enter the Trip Mode. In many applications, the over-voltage condition serves as a warning signal that we have exceeded the deceleration capabilities of the system. The AF91sv inverter has a built-in braking unit, which sends the excess energy from the motor during deceleration to the braking resistor(s). The power resistor serves as a generator load, developing heat to stop the motor just as brakes on an automobile develop heat during braking.

The braking resistor is the main component of a braking resistor assembly, which includes a fuse and thermally activated alarm relay for safety. However, be careful to avoid overheating its resistor. The fuse and thermal relay are safeguards for extreme conditions, but the inverter can maintain braking usage in a safe zone.

The inverter's method uses the duty cycle, or percent of the time braking is on versus total time. Parameter B90 sets the dynamic braking usage ratio. In the graph to the right, the example shows three uses of dynamic braking in a 100-second period. The inverter calculates the average percentage usage in that time (T%). The percentage of usage is proportional to the heat dissipated. If T% is greater than the B90 parameter setting, the inverter enters the Trip Mode and turns off the frequency output. Please note the following:

- When B90 is set for 0%, dynamic braking is not performed.
- When the T% value exceeds the limit set by B90, dynamic braking is terminated.
- When mounting an external dynamic braking unit, set the usage ratio (B90) to 0.0 and remove the external resistors.
- The cable from the external resistor to the inverter must not exceed 5 m (16 ft.) length.
- The individual wires from the resistor to the inverter must not be bundled together.

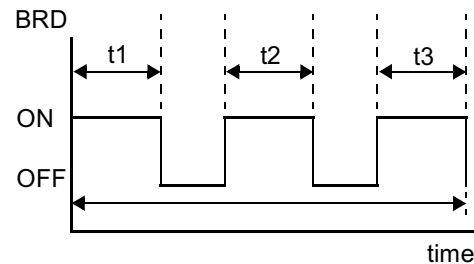

$$\boxed{\text{B90}} \quad T\% = \frac{(t1 + t2 + t3)}{100 \text{ seconds}} \times 100$$

Braking Resistor Table

Inverter models	Minimum Resistance
B007D, B010D	17 Ω
B001D, B002D, B003D, B005	35 Ω
C007D, C010D	70 Ω
BF25D, BF59D, C003D, C005D, C007D, C010D	100 Ω
CF50, C001D, C002D	180 Ω

Troubleshooting and Maintenance



In This Chapter....	page
— Troubleshooting.....	2
— Monitoring Trip Events, History, & Conditions ..	5
— Restoring Factory Default Settings	8
— Maintenance and Inspection	9

Troubleshooting

Safety Messages

Please read the following safety messages before troubleshooting or performing maintenance on the inverter and motor system.



WARNING: Wait at least five (5) minutes after turning off the input power supply before performing maintenance or an inspection. Otherwise, there is the danger of electric shock.



WARNING: Make sure that only qualified personnel will perform maintenance, inspection, and part replacement. (Before starting to work, remove any metallic objects from your person (wristwatch, bracelet, etc.). Be sure to use tools with insulated handles. Otherwise, there is a danger of electric shock and/or injury to personnel.



WARNING: Never remove connectors by pulling on its wire leads (wires for cooling fan and logic p.c.board). Otherwise, there is a danger of fire or injury due to wire breakage.



CAUTION: When removing connectors, never pull the wires (wires for the cooling fan and logic P.C. board). Otherwise, there is danger of fire due to wire breakage and/or injury to personnel.

General Precautions and Notes

- Always keep the unit clean so that dust or other foreign matter does not enter the inverter.
- Take special care in regard to breaking wires or making connection mistakes.
- Firmly connect terminals and connectors.
- Keep electronic equipment away from moisture and oil. Dust, steel filings and other foreign matter can damage insulation, causing unexpected accidents, so take special care.

Inspection Items

This chapter provides instructions or checklists for these inspection items:

- Daily inspection
- Periodic inspection (approximately once a year)
- Insulation resistance test

Troubleshooting Tips

The table below lists typical symptoms and the corresponding solution(s).

Symptom/condition		Probable Cause	Solution							
The motor will not run.	The inverter outputs U, V, W are not supplying voltage.	<ul style="list-style-type: none"> Is the frequency command source A01 parameter setting correct? Is the Run command source A02 parameter setting correct? 	<ul style="list-style-type: none"> Make sure the parameter setting A01 is correct. Make sure the parameter setting A02 is correct. 							
		<ul style="list-style-type: none"> Is power being supplied to terminals L1, L2, and L3(N)? If so, the POWER lamp should be on. 	<ul style="list-style-type: none"> Check terminals L1, L2, and L3(N), then U/T1, V/T2, and W/T3. Turn on the power supply or check fuses. 							
		<ul style="list-style-type: none"> Is there an error code EXX displayed? 	<ul style="list-style-type: none"> Press the Func. key and determine the error type. Then clear the error (Reset). 							
		<ul style="list-style-type: none"> Are the signals to the intelligent input terminals correct? Is the Run Command active? Is the [FW] terminal (or [RV]) connected to P24 (via switch, etc.) 	<ul style="list-style-type: none"> Verify the terminal functions for C01 - C06 are correct. Turn on Run Command. Supply 24V to {FW} or [RV] terminal, if configured. 							
		<ul style="list-style-type: none"> Has the frequency setting for F01 been set greater than zero? Are the control circuit terminals H, O, and L connected to the potentiometer? 	<ul style="list-style-type: none"> Set the parameter for F01 to a safe, non-zero value. If the potentiometer is the frequency setting source, verify voltage at "O" > 0V. 							
		<ul style="list-style-type: none"> Is the RS (reset) function or FRS (free-run stop) function on? 	<ul style="list-style-type: none"> Turn off the command(s). 							
	Inverter outputs U, V, W are supplying voltage.	<ul style="list-style-type: none"> Is the motor load too heavy? 	<ul style="list-style-type: none"> Reduce load, and test the motor independently. 							
The optional remote operator is used	<ul style="list-style-type: none"> Are the operational settings between the remote operator and the inverter unit correct? 	<ul style="list-style-type: none"> Check switches 1 and 2 on optional remote operator (copy unit). <div style="display: flex; align-items: center;"> <div style="margin-right: 10px;">ON</div> <div style="margin-right: 10px;">OFF</div> <div style="border: 1px solid black; padding: 5px; display: inline-block;"> <table style="border-collapse: collapse; text-align: center;"> <tr> <td style="padding: 2px 5px;">1</td> <td style="padding: 2px 5px;">2</td> <td style="padding: 2px 5px;">3</td> <td style="padding: 2px 5px;">4</td> </tr> <tr> <td style="width: 15px; height: 15px; background-color: gray;"></td> <td style="width: 15px; height: 15px; background-color: white;"></td> <td style="width: 15px; height: 15px; background-color: gray;"></td> <td style="width: 15px; height: 15px; background-color: gray;"></td> </tr> </table> </div> <div style="margin-left: 10px;">1: Off 2: On</div> </div>	1	2	3	4				
1	2	3	4							
The direction of the motor is reversed.	<ul style="list-style-type: none"> Are the connections of output terminals U/T1, V/T2, and W/T3 correct? Is the phase sequence of the motor forward or reverse with respect to U/T1, V/T2, and W/T3? 	<ul style="list-style-type: none"> Make connections according to the phase sequence of the motor. In general: FWD = U-V-W, and REV=U-W-V. 								
	<ul style="list-style-type: none"> Are the control terminals [FW] and [RV] wired correctly? Is parameter F04 properly set? 	<ul style="list-style-type: none"> Use terminal [FW] for forward, and [RV] is reverse. Set motor direction in F04. 								

Symptom/condition		Probable Cause	Solution
The motor speed will not reach the target frequency (desired speed).		<ul style="list-style-type: none"> If using the analog input, is the current or voltage at “O” or “OI?” 	<ul style="list-style-type: none"> Check the wiring. Check the potentiometer or signal generating device.
		<ul style="list-style-type: none"> Is the load too heavy? 	<ul style="list-style-type: none"> Reduce the load. Heavy loads activate the overload restriction feature (reduces output as needed).
The rotation is unstable.		<ul style="list-style-type: none"> Is the load fluctuation too great? Is the supply voltage unstable? Is the problem occurring at a particular frequency? 	<ul style="list-style-type: none"> Increase the motor capacity (both inverter and motor). Fix power supply problem. Change the output frequency slightly, or use the jump frequency setting to skip the problem frequency.
The RPM of the motor does not match the inverter output frequency setting.		<ul style="list-style-type: none"> Is the maximum frequency setting A04 correct? Does the monitor function D01 display the expected output frequency? 	<ul style="list-style-type: none"> Verify the V/F settings match motor specifications. Make sure all scaling (such as A11 to A14) is properly set.
Inverter data is not correct.	No downloads have occurred.	<ul style="list-style-type: none"> Was power turned off after a parameter edit but before pressing the Store key? Edits to data are permanently stored at power down. Was the time from power Off to power On less than six seconds? 	<ul style="list-style-type: none"> Edit the data and press the Store key once. Wait six seconds or more before turning power Off after editing data.
	A download to the inverter was attempted.	<ul style="list-style-type: none"> Was the power turned off within six seconds after the display changed from REMT to INV? 	<ul style="list-style-type: none"> Copy the data to the inverter again, and keep power on for six seconds or more after copying.
A parameter will not change after an edit (reverts to old setting).	True for certain parameters	<ul style="list-style-type: none"> Is the inverter in Run Mode? Some parameters cannot be edited during Run Mode. 	<ul style="list-style-type: none"> Put inverter in Stop Mode (press the Stop/reset key). Then edit the parameter.
	True for all parameters	<ul style="list-style-type: none"> If you’re using the [SFT] intelligent input (software lock function), — is the [SFT] input on? Is switch 4 (located on the back of the remote operator copy unit) On? 	<ul style="list-style-type: none"> Change the state of the SFT input, and check the B31 parameter (SFT mode). Turn the switch off.

Monitoring Trip Events, History, & Conditions

Troubleshooting and Maintenance

Inverter Fault Detection

The microprocessor in the inverter detects a variety of fault conditions and latches the event, recording it in a history table. The inverter output turns off, or “trips” similar to the way a circuit breaker trips due to an over-current condition. Most faults occur when the motor is running (refer to the diagram to the right). However, the inverter could have an internal fault and trip in Stop Mode. In either case, you can clear the fault by pressing the Stop/Reset key.

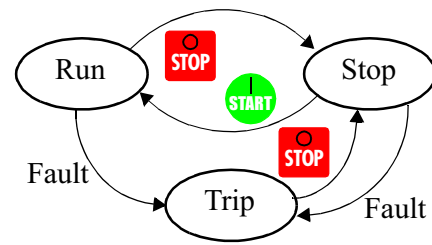

We recommend that you first find the cause of the fault before clearing it. When a fault occurs, the inverter stores important performance data at the moment of the fault. To access the data, use the monitor functions (Dxx) and select D08 for details about the present fault (E^n), or the error code for the past two trip events (E^{n-1} and E^{n-2}) using the D09 Trip History function. A listing of error codes is on the next page.

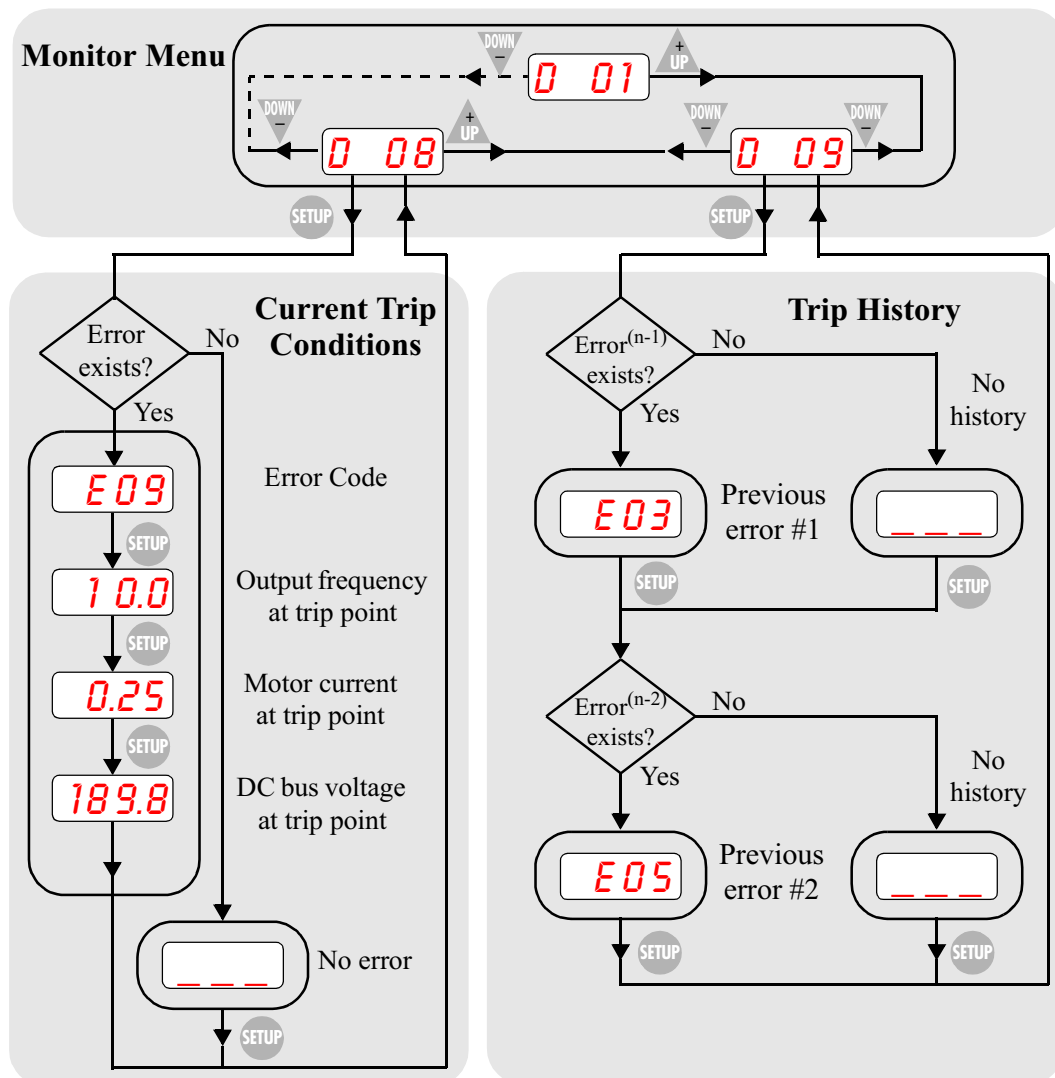

Error Codes

An error code will appear on the display automatically when a fault causes the inverter to trip. The following table lists the cause associated with the error.

Error Code	Name	Cause(s)
<i>E01</i>	Over current event while at constant speed	The inverter output was short-circuited, or the motor shaft is locked or has a heavy load. These conditions cause excessive current for the inverter, so the inverter output is turned off.
<i>E02</i>	Over current event during deceleration	
<i>E03</i>	Over current event during acceleration	
<i>E04</i>	Over current event while motor is stopped	
<i>E05</i>	Overload protection	When a motor overload is detected by the electronic thermal function, the inverter trips and turns off its output.
<i>E06</i>	Braking resistor overload	When the regenerative braking resistor exceeds the usage time allowance or an over-voltage caused by the stop of the BRD function is detected, the inverter trips and turns off its output to the motor.
<i>E07</i>	Over voltage protection	When the DC bus voltage exceeds a threshold, due to regenerative energy from the motor.
<i>E08</i>	EEPROM error	When the built-in EEPROM memory has problems due to noise or excessive temperature, the inverter trips and turns off its output to the motor.
<i>E09</i>	Under-voltage error	A decrease of internal DC bus voltage below a threshold results in a control circuit fault. This condition can also generate excessive motor heat or cause low torque. The inverter trips and turns off its output.
<i>E10</i>	CT (current transformer) error	If a strong source of electrical interference is close to the inverter or abnormal operations occur in the built-in CT (current transformer), the inverter trips and turns its output off.
<i>E11</i> <i>E22</i>	CPU error	A malfunction in the built-in CPU has occurred, so the inverter trips and turns off its output to the motor.
<i>E12</i>	External trip	A signal on an intelligent input terminal configured as EXT has occurred. The inverter trips and turns off the output to the motor.
<i>E13</i>	USP	When the Unattended Start Protection (USP) is enabled, an error occurred when power is cycled while the inverter is in Run Mode. The inverter trips and does not go into Run Mode until the error is cleared.

Error Code	Name	Cause(s)
<i>E14</i>	Ground fault	The inverter is protected by the detection of ground faults between the inverter output and the motor upon during powerup tests. This feature protects the inverter, and does not protect humans.
<i>E15</i>	Input over-voltage	When the input voltage is higher than the specified value, it is detected 100 seconds after powerup and the inverter trips and turns off its output.
<i>E21</i>	Inverter thermal trip	When the inverter internal temperature is higher than the specified value, the thermal sensor in the inverter module detects the higher temperature of the power devices and trips, turning the inverter output off.
<i>E35</i>	PTC error	When intelligent terminal 5 is configured for PTC (protective thermistor) function and the inverter has sensed the resistance is too high (wire is broken or temperature is too high), the inverter trips and turns off the output.



NOTE: If an EEPROM error (E08) occurs, be sure to confirm the parameter data values are still correct. If the power is turned off while the [RS] (Reset) intelligent input terminal is On, an EEPROM error will occur when power is restored.

Restoring Factory Default Settings

























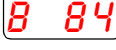

You can restore all inverter parameters to the original factory (default) settings, for the intended country of use. After initializing the inverter, use the powerup test in Chapter 2 to get the motor running again. To initialize the inverter, follow the steps below.

1. First, check the value of function code B85. The initialization in step 2 will restore defaults for the default code programmed in function B85:

01 - 02 = (do not set), **03** = Cutler-Hammer factory defaults

Please do not change this setting unless you are absolutely sure the power input voltage range and frequency match the country code setting.

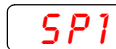
2. Initialization - this uses function code B84. Follow the steps in the table below.

Action	Display	Func./Parameter
Press the  key.		First "D" group parameter
Press the  key three times.		"B" group selected
Press the  key.		First "B" parameter selected
Press and hold the  key until ->		Initialization function selected
Press the  key.		0 = initialization disabled
Press the  key.		1 = initialization enabled
Press the  key.		Initialization now enabled to restore all defaults
Press and hold the  ,  , and  keys. Do not release yet.		First part of special key sequence
Holding the keys above, press and hold the  (STOP) key for 3 sec.		Final part of special key sequence
Release only the  (STOP) key, and wait for the display 0 01 to appear and begin blinking.		Initialization begins when display starts blinking
Now release the  ,  , and  keys only after the 0 01 display function begins blinking.		Default parameter code shown during initialization process (left-most char displays alternating pattern)
Initialization is complete.		Function code for output frequency monitor shown



NOTE: Initialization cannot be performed with a remote operator panel. Disconnect the device and use the inverter's front panel keypad.

Maintenance and Inspection

Monthly and Yearly Inspection Chart

Item Inspected	Check for...	Inspection Cycle		Inspection Method	Criteria	
		Month	Year			
Overall	Ambient environment	Extreme temperatures & humidity	✓		Thermometer, hygrometer	Ambient temperature between -10 to 40°C, non-condensing
	Major devices	Abnormal vibration, noise	✓		Visual and aural	Stable environment for electronic controls
	Power supply voltage	Voltage tolerance	✓		Digital volt meter, measure between inverter terminals L1, L2, L3	200V class: 200 to 240V 50/60 Hz 400V class: 380 to 460V 50/60 Hz
Main circuit	Ground Insulation	Adequate resistance		✓	Digital volt meter, GND to terminals	5 Meg. Ohms or greater
	Mounting	No loose screws		✓	Torque wrench	M3: 0.5 – 0.6 Nm M4: 0.98 – 1.3 Nm M5: 1.5 – 2.0 Nm
	Components	Overheating		✓	Thermal trip events	No trip events
	Housing	Dirt, dust		✓	Visual	Vacuum dust and dirt
	Terminal block	Secure connections		✓	Visual	No abnormalities
	Smoothing capacitor	Leaking, swelling	✓		Visual	No abnormalities
	Relay(s)	Chattering		✓	Aural	Single click when switching On or Off
	Resistors	Cracks or discoloring		✓	Visual	Use Ohm meter to check braking resistors
	Cooling fan	Noise	✓		Power down, manually rotate	Rotation must be smooth
Dust		✓		Visual	Vacuum to clean	
Control circuit	Overall	No odor, discoloring, corrosion		✓	Visual	No abnormalities
	Capacitor	No leaks or deformation	✓		Visual	Undistorted appearance
Display	LEDs	Legibility	✓		Visual	All LED segments work

Note 1: The life of a capacitor is affected by the ambient temperature. See the Capacitor Life Curve on the next page.

Note 2: The inverter must be cleaned periodically. If dust accumulates on the fan and heat sink, it can cause overheating of the inverter.

Spare parts

We recommend that you stock spare parts to reduce down time, which include:

Part description	Symbol	Quantity		Notes
		Used	Spare	
Cooling fan	FAN	1	1	022NF, 030HF, 037LF, 015HF to 075HF
Case	CV	1	1	Front case Key cover Case Bottom cover

Capacitor Life Curve

The DC bus inside the inverter uses a large capacitor as shown in the diagram below. The capacitor handles high voltage and current as it smooths the power for use by the inverter. So, any degradation of the capacitor will affect the performance of the inverter.

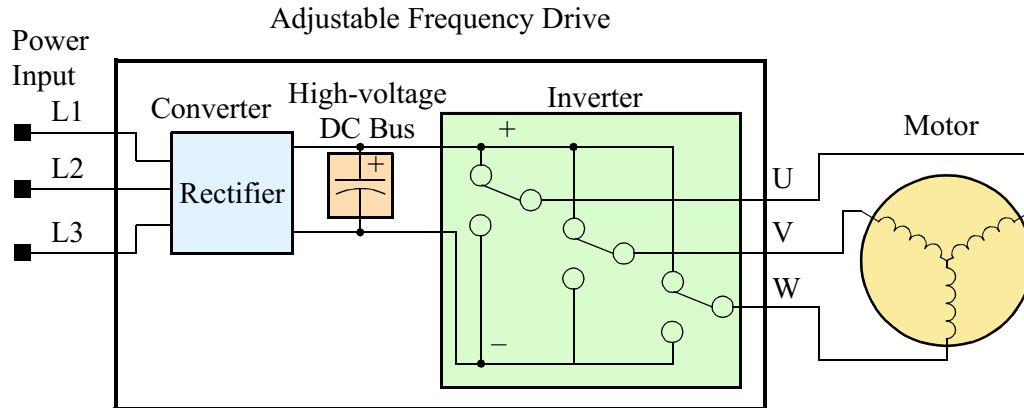

Capacitor life is reduced in higher ambient temperatures, as the graph below demonstrates. Be sure to keep the ambient temperature at acceptable levels, and perform maintenance inspections on the fan, heat sink, and other components. If the inverter is installed on a cabinet, the ambient temperature is the temperature inside the cabinet.

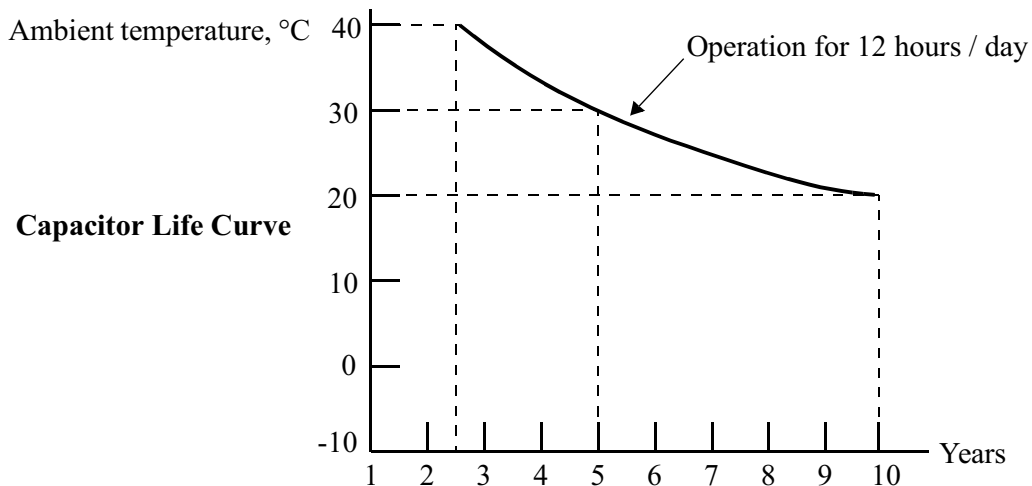

General Inverter Electrical Measurements

The following table specifies how to measure key system electrical parameters. The diagrams on the next page show inverter-motor systems and the location of measurement points for these parameters.

Parameter	Circuit location of measurement	Measuring instrument	Notes	Reference Value
Supply voltage E_1	E_R – across L1 and L2 E_S – across L2 and L3 E_T – across L3 and L1	Moving-coil type voltmeter or rectifier type voltmeter	Fundamental wave effective value	Commercial supply voltage (200V class) 200-240V, 50/60 Hz 400V class 380-460V, 50/60 Hz
Supply current I_1	I_r – L1, I_s – L2, I_t – L3		Total effective value	—
Supply power W_1	W_{11} – across L1 and L2 W_{12} – across L2 and L3		Total effective value	—
Supply power factor Pf_1	$Pf_1 = \frac{W_1}{\sqrt{3} \times E_1 \times I_1} \times 100\%$			—
Output voltage E_0	E_U – across U and V E_V – across V and W E_W – across W and U	Rectifier type voltmeter	Total effective value	—
Output current I_0	I_U – U I_V – V I_W – W	Moving-coil ammeter	Total effective value	—
Output power W_0	W_{01} – across U and V W_{02} – across V and W	Electronic type wattmeter	Total effective value	—
Output power factor Pf_0	Calculate the output power factor from the output voltage E, output current I, and output power W. $Pf_0 = \frac{W_0}{\sqrt{3} \times E_0 \times I_0} \times 100\%$			—

- Note 1:** Use a meter indicating a fundamental wave effective value for voltage, and meters indicating total effective values for current and power.
- Note 2:** The inverter output has a distorted waveform, and low frequencies may cause erroneous readings. However, the measuring instruments and methods listed above provide comparably accurate results.
- Note 3:** A general-purpose digital volt meter (DVM) is not usually suitable to measure a distorted waveform (not pure sinusoid).

The figures below show measurement locations for voltage, current, and power measurements listed in the table on the previous page. The voltage to be measured is the fundamental wave effective voltage. The power to be measured is the total effective power.

Single-phase measurement diagram

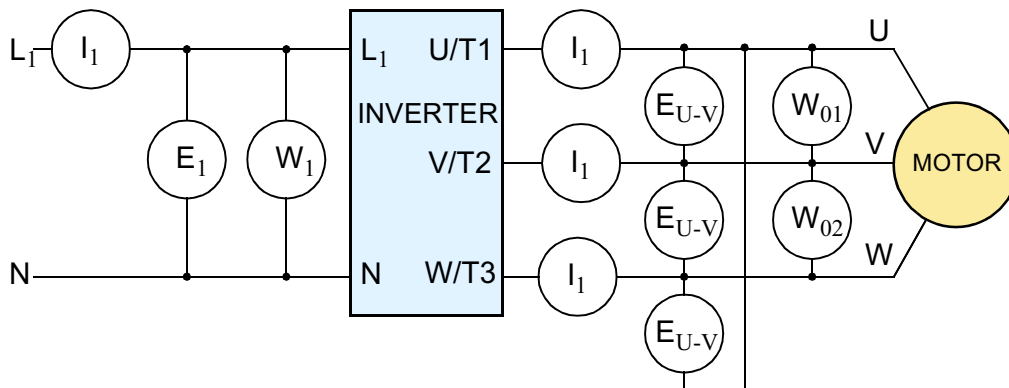

Three-phase measurement diagram

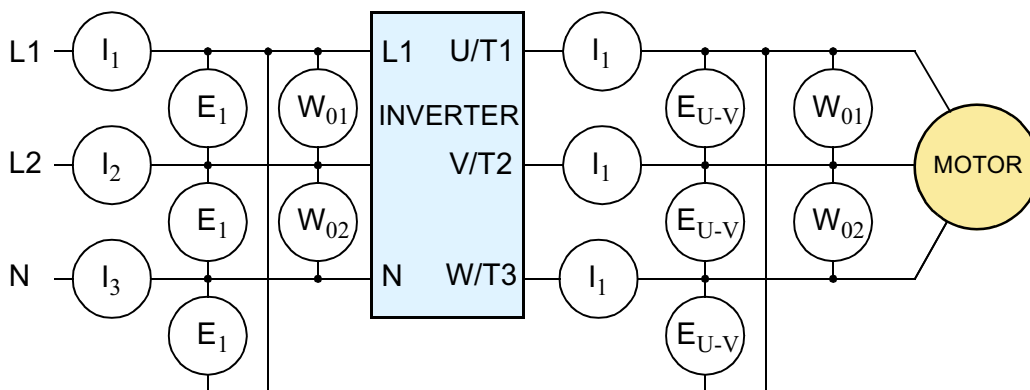

Conduct the insulation resistance test by short circuiting the terminals as shown below.

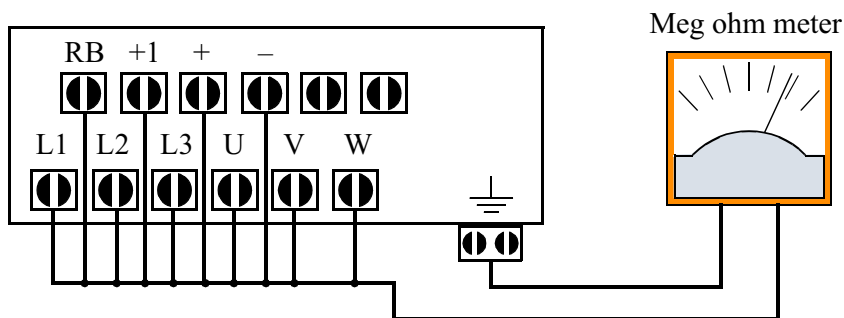

CAUTION: Never test the withstand voltage (HIPOT) on the inverter. The inverter has a surge protector between the main circuit terminals above and the chassis ground.

Inverter Output Voltage Measurement Techniques

Taking voltage measurements around drives equipment requires the right equipment and a safe approach. You are working with high voltages and high-frequency switching waveforms that are not pure sinusoids. Digital voltmeters will not usually produce reliable readings for these waveforms. And, it is usually risky to connect high voltage signals to oscilloscopes. The inverter output semiconductors have some leakage, and no-load measurements produce misleading results. So, we highly recommend using the following circuits to measure voltage for performing the equipment inspections.

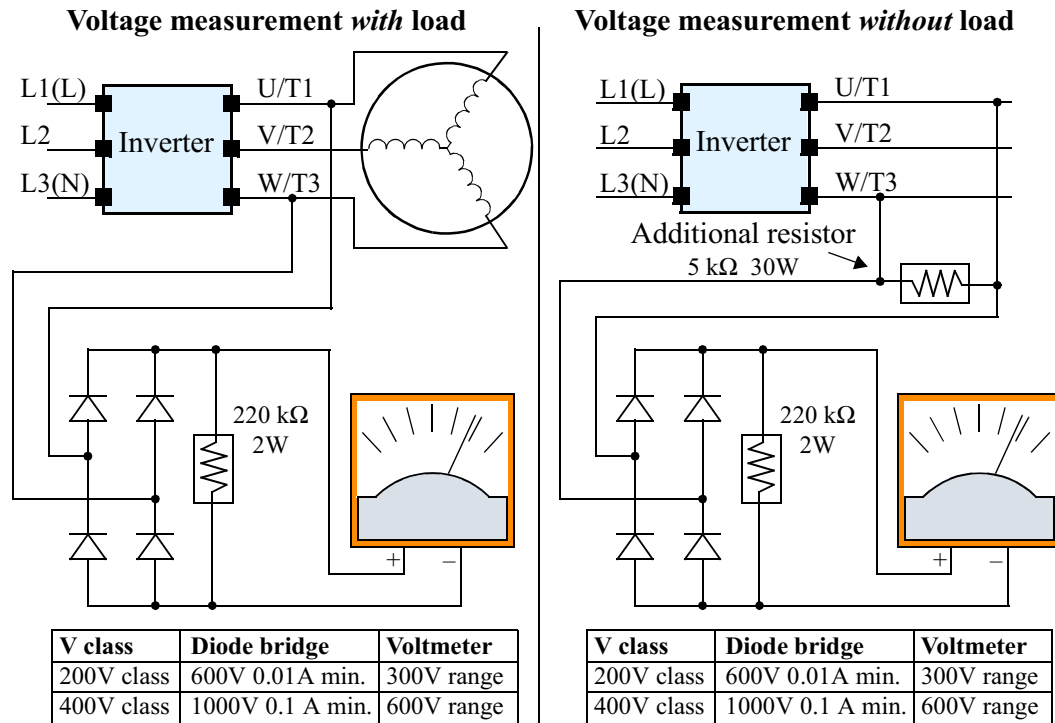

HIGH VOLTAGE: Be careful not to touch wiring or connector terminals when working with the inverters and taking measurements. Be sure to place the measurement circuitry above in an insulated housing before using them.

Glossary and Bibliography

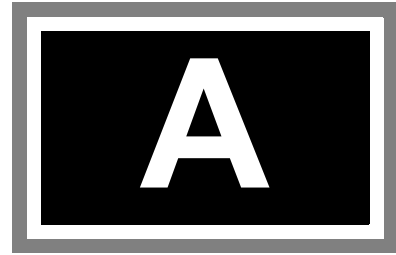

In This Appendix....	page
— Glossary	2
— Bibliography	8

Glossary

- Ambient Temperature** The air temperature in the chamber in which a powered electronic unit resides. A unit's heat sinks rely on a lower ambient temperature in order to dissipate heat away from sensitive electronics.
- Auto-tuning** The ability of a controller to execute a procedure that interacts with a load to determine the proper coefficients to use in the control algorithm. Auto-tuning is a common feature of process controllers with PID loops. Cutler-Hammer inverters feature auto tuning to determine motor parameters for optimal commutation. Auto-tuning is available as a special command from a digital operator panel. See also *digital operator panel*.
- Base Frequency** The power input frequency for which an AC induction motor is designed to operate. Most motors will specify a 50 to 60 Hz value. The Cutler-Hammer inverters have a programmable base frequency, so you must ensure that parameter matches the attached motor. The term *base frequency* helps differentiate it from the carrier frequency. See also *carrier frequency* and *frequency setting*.
- Braking Resistor** Some variable speed drives can cause the motor to develop decelerating torque by switching motor wiring so the motor becomes a generator, connected to an energy-absorbing resistor. See also *four-quadrant operation* and *dynamic braking*.
- Break-away Torque** The torque a motor must produce to overcome the static friction of a load, in order to start the load moving.
- Brushes** A sliding electrical connection between a fixed post inside the motor housing and a ring on the motor shaft. Typically used in DC motors or low-cost AC motors, brushes route current to windings on the rotor. AC induction motors with a squirrel-cage design do not have the need for brushes. See also *commutation* and *squirrel cage*.
- Carrier Frequency** The frequency of the constant, periodic, switching waveform that the inverter modulates to generate the AC output to the motor. See also *PWM*.
- CE** A regulatory agency for governing the performance of electronic products in Europe. Drive installations designed to have CE approval must have particular filter(s) installed in the application.
- Choke** An inductor which is tuned to react at radio frequencies is called a "choke," since it attenuates (chokes) frequencies above a particular threshold. Tuning is often accomplished by using a movable magnetic core. In adjustable frequency drive systems, a choke positioned around high-current wiring can help attenuate harmful harmonics and protect equipment. See also *harmonics*.

DC Braking	The inverter DC braking feature stops the AC commutation to the motor, and sends a DC current through the motor windings in order to stop the motor. Also called “DC injection braking,” it has little effect at high speed, and is used as the motor is nearing a stop.
Dead Band	In a control system, the range of input change for which there is no perceptible change in the output. In PID loops, the error term may have a dead band associated with it. Dead band may or may not be desirable; it depends on the needs of the application.
Digital Operator Panel	For Cutler-Hammer inverters, “digital operator panel” refers first to the operator keypad on the front panel of the inverter. It also includes hand-held remote keypads, which connect to the inverter via a cable.
Diode	A semiconductor device which has a voltage-current characteristic that allows current to flow only in one direction, with negligible leakage current in the reverse direction. See also <i>rectifier</i> .
Duty Cycle	1. The percent of time a square wave of fixed frequency is on (high) versus off (low). 2. The ratio of operating time of a motor, braking resistor, etc. to its resting time. This parameter usually is specified in association with the allowable thermal rise for the device.
Dynamic Braking	The inverter dynamic braking feature shunts the motor-generated EMF energy into a special braking resistor. The added dissipation (braking torque) is effective at higher speeds, having almost no effect as the motor nears a stop.
Error	In process control, the error is the difference between the desired value or setpoint (SP) and the actual value of a the process variable (PV). See also <i>process variable</i> and <i>PID Loop</i> .
EMI	Electromagnetic Interference - In motor/drive systems, the switching of high currents and voltages creates the possibility of generating radiated electrical noise that may interfere with the operation of nearby sensitive electrical instruments or devices. Certain aspects of an installation, such as long motor lead wire lengths, tend to increase the chance of EMI. Cutler-Hammer provides accessory filter components you can install to decrease the level of EMI.
Four-quadrant operation	Referring to a graph of torque versus direction, a four-quadrant drive can turn the motor either forward or reverse, as well as decelerate in either direction (see also <i>reverse torque</i>). A load that has a relatively high inertia and must move in both directions and change directions rapidly requires four-quadrant capability from its drive.
Free-run Stop	A method of stopping a motor, caused when the inverter simply turns off its motor output connections. This may allow the motor and load to coast to a stop, or a mechanical brake may intervene and shorten the deceleration time.

- Frequency Setting** While frequency has a broad meaning in electronics, it typically refers to motor speed for adjustable frequency drives (inverters). This is because the output frequency of the inverter is variable, and is proportional to the attained motor speed. For example, a motor with a base frequency of 60 Hz can be speed controlled with an inverter output varying from 0 to 60 Hz. See also *base frequency*, *carrier frequency*, and *slip*.
- Harmonics** According to Fourier Series mathematics, a periodic (repeating) function (waveform) can be expressed as the summation of a series of pure sine waves of related frequencies. The lowest frequency is the fundamental, while all the other wave components are called *harmonics*. The square waves used in inverters produce high-frequency harmonics, even though the main goal is to produce lower-frequency sine waves. These harmonics can be harmful to electronics (including motor windings) and cause radiated energy that interferes with nearby electronic devices. A choke is sometimes used to suppress the transmission of harmonics in an electrical system. See also *choke*.
- Horsepower** A unit of physical measure to quantify the amount of work done per unit of time. You can directly convert between horsepower and Watts as measurements of power.
- IGBT** **Insulated Gate Bipolar Transistor (IGBT)** - a semiconductor transistor capable of conducting very large currents when in saturation and capable of withstanding very high voltages when it is off. This high-power bipolar transistor is the type used in Cutler-Hammer inverters.
- Inertia** The natural resistance a stationary object to being moved by an external force. See also *momentum*.
- Intelligent Terminal** A configurable input or output logic function on the Cutler-Hammer inverters. Each terminal may be assigned one of several functions.
- Inverter** A device that electronically changes DC to AC current through an alternating process of switching the input to the output, inverted and non-inverted. A variable speed drive such as the Cutler-Hammer AF91sv is also called an inverter, since it contains three inverter circuits to generate 3-phase output to the motor.
- Isolation Transformer** A transformer with 1:1 voltage ratio that provides electrical isolation between its primary and secondary windings. These are typically used on the power input side of the device to be protected. An isolation transformer can protect equipment from a ground fault or other malfunction of nearby equipment, as well as attenuate harmful harmonics and transients on the input power.

Jogging Operation	Usually done manually, a jog command from an operator's panel requests the motor/drive system to run indefinitely in a particular direction, until the machine operator ends the jog operation.
Momentum	The physical property of a body in motion that causes it to continue to move in a straight line. In the case of motors, the armature and shaft are rotating and possesses angular momentum.
Multi-speed Operation	The ability of a motor drive to store preset discrete speed levels for the motor, and control motor speed according to the currently selected speed preset. The Cutler-Hammer inverters have 16 preset speeds.
Motor Load	In motor terminology, motor load consists of the inertia of the physical mass that is moved by the motor and the related friction from guiding mechanisms. See also <i>inertia</i> .
NEC	The National Electric Code is a regulatory document that governs electrical power and device wiring and installation in the United States.
NEMA	The National Electric Manufacturer's Association. NEMA Codes are a published series of device ratings standards. Industry uses these to evaluate or compare the performance of devices made by various manufacturers to a known standard.
Power Factor	A ratio that expresses a phase difference (timing offset) between current and voltage supplied by a power source to a load. A perfect power factor = 1.0 (no phase offset). Power factors less than one cause some energy loss in power transmission wiring (source to load).
PID Loop	Proportional - Integral-Derivative - a mathematical model used for process control. A process controller maintains a process variable (PV) at a setpoint (SP) by using its PID algorithm to compensate for dynamic conditions and vary its output to drive the PV toward the desired value. For adjustable frequency drives, the process variable is the motor speed. See also <i>error</i> .
Process Variable	A physical property of a process which is of interest because it affects the quality of the primary task accomplished by the process. For an industrial oven, temperature is the process variable. See also <i>PID Loop</i> and <i>error</i> .
PWM	Pulse-width modulation: A type of AC adjustable frequency drive that accomplishes frequency and voltage control at the output section(inverter) of the drive. The drive output voltage waveform is at a constant amplitude, and by "chopping" the waveform (pulse-width-modulating), the average voltage is controlled. The chopping frequency is sometimes called the <i>carrier frequency</i> .

Reactance	The impedance of inductors and capacitors has two components. The resistive part is constant, while the reactive part changes with applied frequency. These devices have a complex impedance (complex number), where the resistance is the real part and the reactance is the imaginary part.
Rectifier	An electronic device made of one or more diodes which converts AC power into DC power. Rectifiers are usually used in combination with capacitors to filter (smooth) the rectified waveform to closely approximate a pure DC voltage source.
Regenerative Braking	A particular method of generating reverse torque to a motor, an inverter will switch internally to allow the motor to become a generator and will store the energy internally and/or deliver the braking energy back to the power input supply.
Regulation	The quality of control applied to maintain a parameter of interest at a desired value. Usually expressed as a percent (+/-) from the nominal, motor regulation usually refers to its shaft speed.
Reverse Torque	The force of available from some types of inverters to change the direction of rotation of a motor shaft. As such, reverse torque is a decelerating force on the motor and its external load.
Rotor	The windings of a motor that rotate, being physically coupled to the motor shaft. See also <i>stator</i> .
Saturation Voltage	For a transistor semiconductor device, it is in saturation when an increase in input (gate) current no longer results in an increase in the output (source/drain) current. The saturation voltage is the voltage from the power source to the transistor output (V_{source} to V_{drain}). The ideal saturation voltage is zero.
Sensorless Vector Control	A technique used in adjustable frequency drives to rotate the force vector in the motor without the use of a shaft position sensor (angular). Benefits include an increase in torque at the lowest speed and the cost savings from the lack of a shaft position sensor.
Setpoint (SP)	The setpoint is the desired value of a process variable of interest. See also <i>Process Variable (PV)</i> and <i>PID Loop</i> .
Single-phase	An AC power source consisting of Hot and Neutral wires. A Ground connection usually accompanies them. In theory, the voltage potential on Neutral stays at or near Ground, while Hot varies sinusoidally above and below Neutral. This power source is named Single Phase to differentiate it from three-phase power sources. Some Cutler-Hammer inverters can accept single phase input power, but they all output three-phase power to the motor. See also <i>three-phase</i> .

Slip	The difference between the theoretical speed of a motor at no load (determined by its inverter output waveforms) and the actual speed. Some slip is essential in order to develop torque to the load, but too much will cause excessive heat in the motor windings and/or cause the motor to stall.
Squirrel Cage	A “nick-name” for the appearance of the rotor frame assembly for an AC induction motor.
Stator	The windings in a motor that are stationary and coupled to the power input of the motor. See also rotor.
Tachometer	1. A signal generator usually attached to the motor shaft for the purpose of providing feedback to the speed controlling device of the motor. 2. A speed-monitoring test meter which may optically sense shaft rotation speed and display it on a readout.
Thermal Switch	An electromechanical safety device that opens to stop current flow when the temperature at the device reaches a specific temperature threshold. In variable-speed drive systems, thermal switches are typically installed at or near the motor, in order to protect the windings from heat damage.
Three-phase	An AC power source with three Hot connections that have phase offsets of 120 degrees is a 3-phase power source. Usually, Neutral and Ground wires accompany the three Hot connections. Loads may be configured in a delta or Y configuration. A Y-connected load such as an AC induction motor will be a balanced load; the currents in all the Hot connections are the same. Therefore, the Neutral connection is theoretically zero. This is why inverters, which generate 3-phase power for motors, do not generally have a Neutral connection to the motor. However, the Ground connection is important for safety reasons, and is provided.
Torque	The rotational force exerted by a motor shaft. The units of measurement consist of the distance (radius from shaft center axis) and force (weight) applied at that distance. Units are usually given as pound-feet, ounce-inches, or Newton-meters.
Transistor	A solid state, three-terminal device that provides amplification of signals and can be used for switching and control. While transistors have a linear operating range, inverters use them as high-powered switches. Recent developments in power semiconductors has produced transistors capable of handling hundreds of volts and tens of Amperes or more, all with high reliability. The saturation voltage has been decreasing, resulting in less heat dissipation. Cutler-Hammer inverters use state-of-the-art semiconductors to provide high performance and reliability, all in a compact package. See also <i>IGBT</i> and <i>saturation voltage</i> .
Trip	An event which causes the inverter to stop operation is called a “trip” event (as in <i>tripping</i> a circuit breaker). The inverter keeps a

history log of trip events. They also require an action to clear.

Bibliography

Title	Author and Publisher
Variable Speed Drive Fundamentals, 2nd Ed.	Phipps, Clarence A. The Fairmont Press, Inc. / Prentice-Hall, Inc. 1997 ISBN 0-13-636390-3
Electronic Variable Speed Drives	Brumbach, Michael E. Delmar Publishers 1997 ISBN 0-8273-6937-9
Hitachi Inverter Technical Guide Book	Published by Hitachi, Ltd. Japan 1995 Publication SIG-E002

Drive Parameter Settings Tables

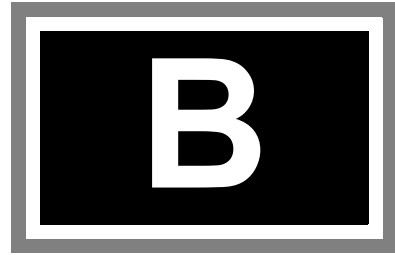

In This Appendix....	page
— Introduction	2
— Parameter Settings for Keypad Entry.....	2
— Parameter Settings for Copy Unit Entry	9

Introduction

This appendix lists the user-programmable parameters for the AF91sv series inverters. The right-most column of the tables is blank, so you can record values you have changed from the default. This involves just a few parameters for most applications. The two sections in this appendix present the parameters in a format oriented toward two different programming devices:

- the keypad on the inverter, and
- the remote Copy Unit

Please refer to the section corresponding to your preferred programming tool.

Parameter Settings for Keypad Entry

AF91sv series inverters provide many functions and parameters which can be configured by the user. We recommend that you record all parameters which have been edited, in order to help in troubleshooting or recovery from a loss of parameter data.

Inverter model AF91sv

MFG. No.

This information is printed on the specification label located on the right side of the inverter.

Main Profile Parameters

"F" Group Parameters		Default Setting	User Setting
Func. Code	Name		
F01	Output frequency setting	0.0	
F02	Acceleration 1	10.0	
F202	Acceleration 1, 2nd motor	10.0	
F03	Deceleration 1	10.0	
F203	Deceleration 1, 2nd motor	10.0	
F04	Running direction setting	0.0	

Standard Functions

“A” Group Parameters		Default Setting	User Setting
Func. Code	Name		
A01	Frequency source setting	00	
A02	Run command source setting	02	
A03	Base frequency setting	60.0	
A203	Base frequency setting, 2nd motor	60.0	
A04	Maximum frequency setting	60.0	
A204	Maximum frequency setting, 2nd motor	60.0	
A11	External frequency output zero reference	0	
A12	External frequency output span reference	0	
A13	External frequency input bias start	0	
A14	External frequency input bias end	100	
A15	External frequency offset enable	01	
A16	External frequency filter time const.	8	
A20	Multi-speed 0 setting	0	
A220	Multi-speed 0 setting, 2nd motor	0	
A21	Multi-speed 1 setting	0	
A22	Multi-speed 2 setting	0	
A23	Multi-speed 3 setting	0	
A24	Multi-speed 4 setting	0	
A25	Multi-speed 5 setting	0	
A26	Multi-speed 6 setting	0	
A27	Multi-speed 7 setting	0	
A28	Multi-speed 8 setting	0	
A29	Multi-speed 9 setting	0	
A30	Multi-speed 10 setting	0	
A31	Multi-speed 11 setting	0	
A32	Multi-speed 12 setting	0	
A33	Multi-speed 13 setting	0	
A34	Multi-speed 14 setting	0	
A35	Multi-speed 15 setting	0	

“A” Group Parameters		Default Setting	User Setting
Func. Code	Name		
A38	Jog frequency setting	1.0	
A39	Jog stop mode	00	
A41	Torque boost method selection	0	
A241	Torque boost method selection, 2nd motor	0	
A42	Manual torque boost value	11	
A242	Manual torque boost value, 2nd motor	11	
A43	Manual torque boost frequency adjustment	10.0	
A243	Manual torque boost frequency adjustment, 2nd motor	10.0	
A44	V/F characteristic curve selection	02	
A244	V/F characteristic curve selection, 2nd motor	02	
A45	V/F gain setting	100	
A51	DC braking enable	00	
A52	DC braking frequency setting	0.5	
A53	DC braking wait time	0.0	
A54	DC braking force setting	0	
A55	DC braking time setting	0.0	
A61	Frequency upper limit setting	0.0	
A62	Frequency lower limit setting	0.0	
A63, A65, A67	Jump (center) frequency setting	0.0	
A64, A66, A68	Jump (hysteresis) frequency width setting	0.5	
A71	PID Function Enable	00	
A72	PID proportional gain	1.0	
A73	PID integral time constant	1.0	
A74	PID derivative gain	0.0	
A75	PV scale conversion	1.00	
A76	PV source setting	00	
A81	AVR function select	02	
A82	AVR voltage select	230/460	

“A” Group Parameters		Default Setting	User Setting
Func. Code	Name		
A92	Second acceleration time setting	15.0	
A292	Second acceleration time setting (2nd motor)	15.0	
A93	Second deceleration time setting	15.0	
A293	Second deceleration time setting (2nd motor)	15.0	
A94	Select method to use second accel/ decel	00	
A294	Select method to use second accel/ decel, 2nd motor	00	
A95	Acc1 to Acc2 frequency transition point	0.0	
A295	Acc1 to Acc2 frequency transition point, 2nd motor	0.0	
A96	Dec1 to Dec2 frequency transition point	0.0	
A296	Dec1 to Dec2 frequency transition point, 2nd motor	0.0	
A97	Acceleration curve selection	00	
A98	Deceleration curve setting	00	

Fine Tuning Functions

"B" Group Parameters		Default Setting	User Setting
Func. Code	Name		
B01	Selection of restart mode	00	
B02	Allowable under-voltage power failure time	1.0	
B03	Delay before motor restart time	1.0	
B12	Level of electronic thermal setting	Rated current for each inverter	
B212	Level of electronic thermal setting, 2nd motor	Rated current for each inverter	
B13	Electronic thermal characteristic	01	
B213	Electronic thermal characteristic, 2nd motor	01	
B21	Overload restriction operation mode	01	
B22	Overload restriction setting	Rated current x 1.25	
B23	Deceleration rate at overload restriction	1.0	
B31	Software lock mode selection	01	
B32	Reactive current setting	Rated current x 0.58	
B81	Analog frequency meter adjustment	80	
B82	Start frequency adjustment	0.5	
B83	Carrier frequency setting	5.0	
B84	Initialization mode (parameters or trip history)	00	
B85	Country code for initialization	03	
B86	Frequency scalar conversion factor	1.0	
B87	STOP key enable	00	
B88	Resume on FRS cancellation mode	00	
B89	Data select for digital operator	01	
B90	Dynamic braking usage ratio	0.0	
B91	Stop mode selection	00	
B92	Cooling fan control	00	

Intelligent Terminal Functions

“C” Group Parameters		Default Setting	User Setting
Func. Code	Name		
C01	Terminal 1 function	00	
C02	Terminal 2 function	01	
C03	Terminal 3 function	06	
C04	Terminal 4 function	13	
C05	Terminal 5 function	16	
C06	Terminal 6 function	18	
C11	Terminal 1 active state	00	
C12	Terminal 2 active state	00	
C13	Terminal 3 active state	00	
C14	Terminal 4 active state	00	
C15	Terminal 5 active state	00	
C16	Terminal 6 active state	00	
C21	Terminal 11 function (logical)	01	
C22	Terminal 12 function (logical)	00	
C23	Terminal FM function (analog)	00	
C24	Alarm relay terminal function (logical)	05	
C31	Terminal 11 active state	00	
C32	Terminal 12 active state	00	
C33	Alarm relay active state	01	
C41	Overload level setting	Inverter rated current	
C42	Frequency arrival setting for accel.	0.0	
C43	Arrival frequency setting for decel.	0.0	
C44	PID deviation level setting	3.0	
C81	Analog meter adj., voltage input	Factory-set	
C82	Analog meter adj., current input	Factory-set	
C91	Debug mode selection	00	Do not edit
C92	Core monitor address	0000	Do not edit
C93	Core monitor date	—	Do not edit
C94	Core set address	d001	Do not edit
C95	Core set date	00	Do not edit

Sensorless Vector Functions

“H” Group Parameters		Default Setting	User Setting
Func. Code	Name		
H01	Auto-tuning Setting	00	
H02	Motor data selection	00	
H202	Motor data selection, 2nd motor	00	
H03	Motor capacity	Specified by the inverter capacity	
H203	Motor capacity, 2nd setting	Specified by the inverter capacity	
H04	Motor poles setting	4	
H204	Motor poles setting, 2nd motor	4	
H05	Motor constant Kp	20	
H205	Motor constant Kp, 2nd motor	20	
H06	Motor stabilization constant	100	
H206	Motor stabilization constant, 2nd motor	100	
H20	Motor constant R1	Factory set	
H220	Motor constant R1, 2nd motor	Factory set	
H21	Motor constant R2	Factory set	
H221	Motor constant R2, 2nd motor	Factory set	
H22	Motor constant L	Factory set	
H222	Motor constant L, 2nd motor	Factory set	
H23	Motor constant Io	Factory set	
H223	Motor constant Io, 2nd motor	Factory set	
H24	Motor Constant J	Factory set	
H224	Motor constant J, 2nd motor	Factory set	

Parameter Settings for Copy Unit Entry

AF91sv series inverters provide many functions and parameters which can be configured by the user. We recommend that you record all parameters which have been edited, in order to help in troubleshooting or recovery from a loss of parameter data.

Inverter model AF91sv

MFG. No.

This information is printed on the specification label located on the right side of the inverter.

Monitor Mode Parameters

Monitor Mode Setup		Displayed Default Setting	User Setting
Func. Code	Name		
Mon.	Frequency setting	TM 031.6 0.0Hz	
	Acceleration time	ACC 0010.0s	
	Acceleration time, 2nd motor	2ACC 0010.0s	
	Deceleration time	DEC 0010.0s	
	Deceleration time, 2nd motor	2DEC 0010.0s	
	Frequency setting	F-SET-SELECT TRM	
	Frequency source select	F/R-SELECT TRM	
	Scaled frequency value	/Hz01.0 0.00	
	Output current display	Im 0.0A 0.0%	
	Manual torque boost	V-Boost code 11	
	Manual torque boost, 2nd motor	2V-Boost code 11	
	Torque boost frequency setting	V-Boost F 10.0%	
	Torque boost frequency setting, 2nd motor	2V-Boost F 10.0%	
	Torque boost mode	V-Boost Mode 0	
	Torque boost mode, 2nd motor	2V-Boost Mode 0	
	Output voltage gain adj.	V-Gain 100%	
	Jog frequency	Jogging 1.00Hz	
	Jog mode select	Jog Mode 0	

Monitor Mode Setup		Displayed Default Setting	User Setting
Func. Code	Name		
Mon.	Analog voltage input adjustment	ADJ-O 097	
	Analog current input adjustment	ADJ-OI 079	
	Analog adjustment	ADJ 080	
	Panel display selection	PANEL d01	
	Terminal monitor	TERM LLL LLLLLL	
	Accumulation of Run Mode time since mfg.	RUN 000003H	
	Alarm display	ERR1 Under.V	
		ERR1 10.0Hz	
		ERR1 0.2A	
		ERR1 189.8Vdc	
		ERR1 RUN 000003H	
	Total alarm count	ERROR COUNT 002	
	Trip history, previous alarm (example)	ERR2 Under.V	
		ERR2 10.0Hz	
		ERR2 0.2A	
		ERR2 189.8Vdc	
		ERR2 RUN 000003H	
	Trip history, 2nd previous alarm	ERR3 #	

Function Mode Setup

Function Mode Setup		Displayed Default Setting	User Setting
Func. Code	Name		
F-00	Base frequency setting	F-BASE 060Hz	
F-01	Maximum frequency setting	F-MAX 060Hz	
F-02	Start frequency adjustment	Fmin 0.5Hz	
F-03	Motor input voltage	AVR AC 230V	
	AVR function for deceleration	AVR MODE DOFF	

Function Mode Setup		Displayed Default Setting	User Setting
Func. Code	Name		
F-04	Control method setting	CONTROL SLV	
F-05	Auto-tuning setting	AUX AUTO NOR	
	Motor date selection	AUX DATA NOR	
	Motor date selection, 2nd motor	2AUXDATA NOR	
	Motor capacity setting	AUX K 0.4 kW	
	Motor capacity setting, 2nd motor	2AUXK 0.4 kW	
	Motor pole count setting	AUX P 4p	
	Motor pole count setting, 2nd motor	2AUXP 4p	
	Motor constant R1 setting	AUX R1 05.700 δ	
	Motor constant R1 setting, 2nd motor	2AUXR1 05.700 δ	
	Motor constant R2 setting	AUX R2 02.773 δ	
	Motor constant R2 setting, 2nd motor	2AUXR2 02.773 δ	
	Motor constant L setting	AUX L 045.70mH	
	Motor constant L setting, 2nd motor	2AUXL 045.70mH	
	Motor constant IO setting	AUX IO 001.50A	
	Motor constant IO setting, 2nd motor	2AUXIO 001.50A	
	Motor constant J setting	AUX J 0020.0	
	Motor constant J setting, 2nd motor	2AUXJ 0020.0	
	Motor constant Kp setting	AUX KP 20	
	Motor constant Kp setting, 2nd motor	2AUXKP 20	
	Motor stabilization constant setting	AUX KCD 100	
Motor stabilization constant, 2nd motor	2AUXKCD 100		

Function Mode Setup		Displayed Default Setting	User Setting
Func. Code	Name		
F-06	Acceleration time 1	ACC 1 0010.0s	
	Acceleration time 1, 2nd motor	2ACC1 0010.0s	
	2-stage acceleration time	ACC CHG TM	
	2-stage acceleration time, 2nd motor	2ACCCHG TM	
	Acceleration time 2	ACC 2 0015.0s	
	Acceleration time 2, 2nd motor	2ACC2 0015.0s	
	Acceleration time change frequency	ACC CHFr 000.0Hz	
	Acceleration time change frequency, 2nd motor	2ACCCHFr 000.0Hz	
	Acceleration curve selection	ACC LINE L	
F-07	Deceleration time 1	DEC 1 0010.0s	
	Deceleration time 1, 2nd motor	2DEC1 0010.0s	
	Deceleration time 2	DEC 2 0015.0s	
	Deceleration time 2, 2nd motor	2DEC 2 0015.0s	
	Deceleration time change frequency setting	DEC CHFr 000.0Hz	
	Deceleration time change frequency setting, 2nd motor	2DECCHFr 000.0Hz	
	Deceleration curve setting	DEC LINE L	
F-10	Restart after FRS signal selection	RUN FRS ZST	
	Stop mode selection	RUN STP DEC	

Function Mode Setup		Displayed Default Setting	User Setting
Func. Code	Name		
F-11	Output frequency setting	SPD FS 000.0Hz	
	Multi-stage 1 setting	SPD 1 000.0Hz	
	Multi-speed 2 setting	SPD 2 000.0Hz	
	Multi-speed 3 setting	SPD 3 000.0Hz	
	Multi-speed 4 setting	SPD 4 000.0Hz	
	Multi-speed 5 setting	SPD 5 000.0Hz	
	Multi-speed 6 setting	SPD 6 000.0Hz	
	Multi-speed 7 setting	SPD 7 000.0Hz	
	Multi-speed 8 setting	SPD 8 000.0Hz	
	Multi-speed 9 setting	SPD 9 000.0Hz	
	Multi-speed 10 setting	SPD 10 000.0Hz	
	Multi-speed 11 setting	SPD 11 000.0Hz	
	Multi-speed 12 setting	SPD 12 000.0Hz	
	Multi-speed 13 setting	SPD 13 000.0Hz	
	Multi-speed 14 setting	SPD 14 000.0Hz	
Multi-speed 15 setting	SPD 15 000.0Hz		
F-20	DC braking enable	DCB SW OFF	
	DC braking frequency	DCB F 00.5Hz	
	DC braking time delay	DCB WAIT 0.0s	
	DC braking force	DCB V 000	
	DC braking time	DCB T 00.0s	
F-21	Dynamic braking selection	BRD-%ED 000.0%	
F-22	Allowable instantaneous power failure	IPS UVTIME 01.0s	
	Standby time after power failure recovery	IPS WAIT 001.0s	
	Instantaneous power failure restart selection	IPS POWR ALM	

Function Mode Setup		Displayed Default Setting	User Setting
Func. Code	Name		
F-23	Electronic thermal cut-off characteristic	E-THM CHAR CRT	
	Electronic thermal cut-off characteristic, 2nd motor	E-THMCHAR CRT	
	Electronic thermal level	E-THM LVL 03.00A (rated output current)	
	Electronic thermal level, 2nd motor	2E-THMLVL 03.00A (rated output current)	
F-24	Overload limit setting	OLOAD LVL 03.75A (rated current * 1.25A)	
	Overload limit constant	OLOAD CONST 01.0	
	Overload limit load	OLOAD MODE ON	
F-25	Software lock selection	S-LOCK MD1	
F-26	Frequency lower limit	LIMIT L 000.0Hz	
	Frequency upper limit	LIMIT H 000.0Hz	
F-27	Jump frequency 1	JUMP F1 000.0Hz	
	Jump frequency 2	JUMP F2 000.0Hz	
	Jump frequency 3	JUMP F3 000.0Hz	
	Jump frequency width (hysteresis) 1	JUMP W1 00.5Hz	
	Jump frequency width (hysteresis) 3	JUMP W2 00.5Hz	
	Jump frequency width (hysteresis) 3	JUMP W3 00.5Hz	
F-28	Stop key enable during terminal mode	STOP-SW ON	
F-31	External frequency start (output bias setting)	IN EXS 000.0Hz	
	External frequency end (output span setting)	IN EXE 000.0Hz	
	External frequency start (input bias)	IN EX%S 000%	
	External frequency start (input span)	IN EX%E 100%	
	External frequency start point (input offset)	IN LEVEL 0Hz	
	External input filter time constant	IN F-SAMP 8	

Function Mode Setup		Displayed Default Setting	User Setting
Func. Code	Name		
F-32	Frequency arrival threshold during acceleration	ARV ACC 000.0Hz	
	Frequency arrival threshold during deceleration	ARV DEC 000.0Hz	
F-33	Overload previous level	OV Load 03.00A (rated current)	
	Error overload (threshold) for PID loop	OV PID 003.0%	
F-34	Intelligent input 1 function code	IN-TM 1 FW	
	Intelligent input 2 function code	IN-TM 2 RV	
	Intelligent input 3 function code	IN-TM 3 AT	
	Intelligent input 4 function code	IN-TM 4 USP	
	Intelligent input 5 function code	IN-TM 5 2CH	
	Intelligent input 6 function code	IN-TM 6 RS	
	Intelligent input 1 NO/NC (active state)	IN-TM O/C-1 NO	
	Intelligent input 2 NO/NC (active state)	IN-TM O/C-2 NO	
	Intelligent input 3 NO/NC (active state)	IN-TM O/C-3 NO	
	Intelligent input 4 NO/NC (active state)	IN-TM O/C-4 NC	
	Intelligent input 5 NO/NC (active state)	IN-TM O/C-5 NO	
	Intelligent input 6 NO/NC (active state)	IN-TM O/C-6 NO	

Function Mode Setup		Displayed Default Setting	User Setting
Func. Code	Name		
F-35	Intelligent output 11 function code	OUT-TM 1 FA1	
	Intelligent output 12 function code	OUT-TM 2 RUN	
	Relay output function code	OUT-TM RY AL	
	Relay output NO/NC (active state)	OUT-TM O/C-RY NC	
	Intelligent output 11 NO/NC (active state)	OUT-TM O/C-1 NO	
	Intelligent output 12 NO/NC (active state)	OUT-TM O/C-2 NO	
F-36	Carrier frequency setting	CARRIER 05.0kHz	
F-37	Monitor signal selection	MONITOR A-F	
F-38	Initialization country code for default settings	INIT SEL USA	
	Debug mode display selection	INIT DEBG OFF	
	Motor rotation direction	INIT DOPE FWD	
	Initial mode selection	INIT MODE TRP	
	Cooling fan control mode	INIT FAN-CTL OFF	
F-43	PID loop enable	PID SW OFF	
	PID proportional gain	PID P 1.0	
	PID integral gain	PID I 001.0s	
	PID derivative gain	PID D 000.0	
	PID scale factor setting	PID CONV 01.00	
	PID input (PV) selection	PID INPT CUR	

Function Mode Setup		Displayed Default Setting	User Setting
Func. Code	Name		
F-50	Torque boost mode selection	V-Boost Mode 0	
	Torque boost mode selection, 2nd motor	2V-Boost Mode 0	
	Torque boost manual adjustment	V-Boost code 11	
	Torque boost manual adjustment, 2nd motor	2V-Boost code 11	
	Torque boost frequency adjustment	V-Boost F 10.0%	
	Torque boost frequency adjustment, 2nd motor	2V-Boost F 10.0%	

Index



A

- A Group standard functions 3–8
- AC motor 1–17
- AC reactors 5–3
- Acceleration 3–7, 3–17
 - two-stage 4–12
- Access levels 2–2
- Accessories 5–2
- Adjustable-frequency control 3–5
- Adjustable-frequency drive
 - definition 1–15
- Alarm signal 4–25
- Alarm terminals 4–5
- Analog I/O terminals 4–5
- Analog input operation 4–27
 - current/voltage select 4–17
- Analog input settings 3–9
- Analog output operation 4–28
 - current/voltage select 4–17
- Automatic voltage regulation 3–16
- Auto-tuning 4–30
- AVR function 3–16

B

- B Group fine tuning settings 3–19
- Base frequency 3–8
- Bibliography A–8
- Books on adjustable frequency drives A–8
- Braking 1–18
 - dynamic 5–5
 - resistive 1–22
 - settings 3–13
 - usage ratio 3–23

C

- C Group intelligent terminal functions 3–26
- Capacitor life curve 6–10
- Carrier frequency 3–23
- Connection to PLC 4–4
- Constant torque 3–5, 3–8, 3–11
- Constant volts/hertz 1–16
- Copy Unit 1–20
 - parameter settings B–9
- Cover removal 2–16
- Current monitor signal 4–29

D

- D Group monitoring functions 3–6
- DC braking 4–9, 4–10, A–3
- DC braking settings 3–13
- Deceleration 3–7, 3–17, 3–21, 4–9
 - two-stage 4–12
- Default settings 6–8
- Definitions A–2
- Derivative gain 3–15
- Digital operator panel 1–18
- Dimensions 2–8
 - terminals 2–15
- Down function 4–20
- Dynamic braking 5–5, A–3

E

Editing parameters 2–22
EEPROM 1–18
Electronic thermal overload alarm 3–20
Environmental conditions 6–9
Environmental specs 1–6
Error codes 6–6
Event clearing 4–18
External frequency command 3–9
External trip event 4–14

F

F Group functions 3–7
Factory default settings 6–8
Fan control 3–25
Fault 4–25
Faults 6–5
Features 1–2, 2–2
Fine tuning settings 3–19
Forward run command 4–6
Free-run stop 4–9, 4–13
Frequency arrival signal 4–22
Frequency command settings 3–14
Frequency display scaling 3–23
Frequency limits 3–14
Frequency modulation 4–28
Frequency monitor signal 4–29
Frequency remote control 4–20
Frequency source setting 3–8
Frequently asked questions 1–20
Front panel 3–3
Front panel controls 2–19
Fuses 2–13

G

Glossary of terms A–2

H

H Group sensorless vector functions 3–34
History 6–5
History of trip events 3–7

I

Initialization 3–23, 6–8
Input power wiring 2–14
Input terminal functions 3–26, 4–6
Inspection 2–2, 6–9
 electrical measurements 6–11
 measurement techniques 6–13
Installation instructions 2–6
Integral gain 3–15
Intelligent input terminals 4–6
Intelligent output terminals 4–21
Intelligent terminal functions 3–26

J

Jog command 4–9
Jog frequency 3–10
Jump frequency 3–14

K

Keypad 2–19
 key functions 3–3
 navigational map 2–21, 3–4
 parameter settings B–2

L

Logic connections 4–4
Logic I/O terminals 4–5

M

Main profile parameters 3–7
Maintenance 6–9
Model number 1–3
Modes of operation 2–26, 3–5
Monitoring functions 3–6
Monitoring parameters 2–25
Monitoring trip events 6–5
Motor
 multiple-motor operation 4–34
 purpose of speed control 1–15
 running 2–25
 second settings 3–17, 3–34
 speed calculation 2–26
 thermal protection 4–19

Motor poles 1–22, 2–24
Mounting dimensions 2–8
Mounting location 2–6
Multiple-motor operation 4–34
Multi-speed profile 1–19
Multi-speed select settings 4–7
Multi-speed setting 3–10

O

Operational modes 3–5
Optional components 2–5, 5–2
Orientation 2–2
Output deviation for PID loop 4–24
Output frequency 3–7
Output terminal functions 3–30, 4–21
Output wiring 2–16
Overload advance notice signal 4–23
Overload restriction setting 3–21

P

Parameter editing 2–19, 2–22
Parameter monitoring 2–25
Parameter settings
 Copy Unit B–9
 keypad entry B–2
Parameters 2–20
PID loop 1–22
 error deviation signal 4–24
 operation 4–33
PID Loop settings 3–15
PLC connection 4–4
Potentiometer 2–23
Powerup test 2–17
 observations 2–26
Programming
 devices 3–2
 read/write copy unit 3–5
Proportional gain 3–15
PTC thermistor thermal protection 4–19
Pulse-width modulation 4–28
PV source setting 3–15

R

Reduced torque 3–5, 3–11
Relay contacts 4–25
Remote control 4–20
Reset function 4–18
Resistor
 braking 5–5
Restart mode 3–19
Reverse run command 4–6
Run command 4–6
Run signal 4–21

S

Second motor 4–34
Second motor setting 4–11
Second motor settings 3–17, 3–34
Sensorless vector control 3–5, 4–30
Sensorless vector functions 3–34
Single-phase power 1–21
Software lock function 4–16
Software lock mode 3–22
Spare parts 6–10
Specifications
 by voltage class 1–4
 control and logic connections 4–5
 general 1–6
 label 1–3
Standard functions 3–8
Step-up transformer 1–21
System description 2–5
System diagram 5–2

T

- Terminal tightening torque 2-15
- Thermal overload setting 3-20
- Thermistor thermal protection 4-19
- Three-phase power 1-17, 1-21
- Torque 1-16
- Torque boost 3-11
- Trip event 3-7
 - external 4-14
- Trip events 6-5
- Trip mode 4-18, 4-25
- Troubleshooting Tips 6-3
- Two-stage acceleration and deceleration 4-12

U

- Unattended Start Protection 4-15
- Up function 4-20
- USP 4-15

V

- V/F characteristics 3-11
- Velocity profile 1-19

W

- Wiring
 - caution messages 2-12
 - gauge 2-13
 - input power 2-14
 - output to motor 2-16

Cutler-Hammer, a part of Eaton Corporation, is a world-wide leader providing customer-driven solutions. From power distribution and electrical control products to industrial automation, Cutler-Hammer utilizes advanced product development, world-class manufacturing, and offers global engineering services and support.

For more information on Cutler-Hammer products and services, call 1-800-525-2000 or 1-616-982-1059, or visit our web site at www.cutlerhammer.eaton.com

For Cutler-Hammer Adjustable Frequency Drives technical information and support, please call 1-800-322-4986.

Cutler-Hammer

Milwaukee, Wisconsin U.S.A.

Publication No. TD.08H.37B.T.E
January 2001

Copyright Cutler-Hammer Inc. 2001
All Rights Reserved



NB586XB