

PRICE \$15.00

SERVICE BULLETIN 8804-3

March, 1988

Supersedes March, 1986 Issue

SQUARE D[®]

omegapak[®]
Adjustable Frequency Controller

**50 - 100 HORSEPOWER (CONSTANT TORQUE)
60 - 125 HORSEPOWER (VARIABLE TORQUE)**

CONTENTS

NOTE: This service bulletin covers the installation, start-up and servicing of standard controllers and controllers with pre-engineered options. Controllers having variations or special options will be furnished with a set of record drawings which must be consulted to properly and safely install, start-up or service the controller.

1.0 GENERAL

- 1.1 PRECAUTIONS
- 1.2 PRELIMINARY INSPECTION
- 1.3 STORAGE
- 1.4 CONTROLLER IDENTIFICATION
- 1.5 KITS FOR FIELD INSTALLATION

2.0 INSTALLATION

- 2.1 MECHANICAL INSTALLATION
- 2.2 ELECTRICAL INSTALLATION
 - 2.2.1 INPUT POWER
 - 2.2.2.A INPUT WIRING
 - 2.2.2.B POWER BUS INSTALLATION
 - 2.2.2.C GROUND BUS INSTALLATION
 - 2.2.3 OUTPUT POWER
 - 2.2.4 CONTROL WIRING
 - 2.2.5 WIRING PRACTICE

3.0 APPLICATION DATA

- 3.1 BASIC CONTROLLER
 - 3.1.1 INPUT
 - 3.1.2 OUTPUT
 - 3.1.3 PERFORMANCE
 - 3.1.4 ENVIRONMENTAL CONDITIONS
 - 3.1.5 ADJUSTMENTS
 - 3.1.6 PROTECTION
 - 3.1.7 DIAGNOSTIC AND STATUS INDICATORS
- 3.2 OPTIONS
 - 3.2.1 OPTION BOARDS
 - 3.2.2 DYNAMIC BRAKING
 - 3.2.3 CONTROLLER MOUNTED PILOT DEVICES
 - 3.2.4 OUTPUT ISOLATION CONTACTOR
 - 3.2.5 ISOLATION AND BYPASS CONTACTORS
 - 3.2.6 POWER AND GROUND BUS
 - 3.2.7 METERS
 - 3.2.8 REGENERATIVE BRAKING

4.0 CONTROLLER PHOTOS

- 4.1 OMEGAPAK 1500 CONTROLLER
- 4.2 OMEGAPAK 3500 CONTROLLER — WITH ELECTRONICS DOOR OPEN
- 4.3 OMEGAPAK 3500 CONTROLLER — W/MAIN DOOR OPEN
- 4.4 CLOSE-UP OF CONTROLLER INSIDE
- 4.5 GROUND BUS ACCESS — HEATSINK FAN REMOVAL
- 4.6 GROUND BUS ACCESS — FAN BRACKET REMOVAL
- 4.7 CLOSE-UP OF MAIN CONTROL AND OPTION BOARD
- 4.8 CLOSE-UP OF POWER INTERFACE BOARD
- 4.9 INVERTER IN SERVICE POSITION
- 4.10 CLOSE-UP OF INVERTER ASSEMBLY

5.0 INITIAL START-UP PROCEDURE

- 5.1 CONTROLLER WITHOUT OPTION BOARD
- 5.2 CONTROLLER WITH OPTION BOARD

6.0 CONTROLLER ADJUSTMENTS

- 6.1 MAIN CONTROL BOARD ADJUSTMENTS
 - 6.1.1 INPUT VOLTAGE SELECTION
 - 6.1.2 INPUT FREQUENCY SELECTION
 - 6.1.3 CONTROLLER FAULT LOCK-OUT SELECTION
 - 6.1.4 ACCEL/DECCEL TIME RANGE SELECTION
 - 6.1.5 MAXIMUM OUTPUT FREQUENCY SELECTION
 - 6.1.6 POTENTIOMETER ADJUSTMENTS
- 6.2 OPTION BOARD ADJUSTMENTS
 - 6.2.1 VOLTAGE/CURRENT FOLLOWER SELECTION
 - 6.2.2 INCOMPLETE SEQUENCE TIME SELECTION

- 6.2.3 POTENTIOMETER ADJUSTMENTS
 - 6.2.3.A ISOLATED OPTION BOARD
 - 6.2.3.B NON-ISOLATED OPTION BOARDS
 - 6.2.3.C PNEUMATIC OPTION BOARD
- 6.3 METER ADJUSTMENTS
 - 6.3.1 ANALOG SPEED METER
 - 6.3.2 DIGITAL SPEED METER
 - 6.3.3 ANALOG VOLTMETER
 - 6.3.4 DIGITAL VOLTMETER
 - 6.3.5 ANALOG AMMETER
 - 6.3.6 DIGITAL AMMETER
- 7.0 DIAGNOSTIC AND STATUS INDICATING LIGHTS
 - 7.1 MAIN CONTROL BOARD
 - 7.2 GATE DRIVER BOARD
 - 7.3 POWER INTERFACE BOARD
 - 7.4 OPTION BOARD
 - 7.5 DYNAMIC BRAKING BOARD
 - 7.6 STANDBY MODE LAMP STATUS
- 8.0 POTENTIOMETER, SELECTION SWITCH, LED AND SNIP-OUT COMPONENT PLACEMENT CHART
 - 8.1 MAIN CONTROL BOARD
 - 8.2 OPTION BOARD
- 9.0 CONTROLLER OPERATION
 - 9.1 BLOCK DIAGRAM DESCRIPTION
 - 9.2 CONTROL CIRCUIT SEQUENCE
 - 9.2.1 PILOT LIGHTS, ELAPSED TIME METER, HEAT SINK FAN(S)
 - 9.2.2 START-STOP PUSH BUTTONS
 - 9.2.3 HAND/AUTO SELECTOR SWITCH AND START STOP
 - 9.2.4 HAND-OFF-AUTO SELECTOR SWITCH
 - 9.2.5 START-STOP, FAST STOP PUSH BUTTONS AND RUN-JOG FORWARD-REVERSE SELECTOR SWITCHES
 - 9.2.6 HAND-OFF-AUTO SELECTOR SWITCH, DRIVE FAIL RELAY, AUXILIARY SEQUENCE RELAYS NO. 1 AND NO. 2 AND ISOLATION OR ISOLATION/BYPASS CONTACTORS, INCOMPLETE SEQUENCE TIMER
- 10.0 TROUBLESHOOTING AND MAINTENANCE GUIDE (REFER TO SECTION 10 FOR CONTENTS)
- 11.0 CONTROLLER DRAWINGS (REFER TO SECTION 11 FOR CONTENTS)
- 12.0 RENEWAL PARTS LIST

1.0 GENERAL

1.1 PRECAUTIONS

The following list of "PRECAUTIONS" must be studied and followed during the installation, operation, and servicing of the equipment.

1. Read this service bulletin prior to installing or operating the equipment.
2. Service work should be performed only after becoming familiar with all listed danger and caution statements.
3. If OMEGAPAK controllers are to be stored prior to installation, they must be protected from the weather and kept free of condensation and dust.
4. Use extreme care when moving or positioning controllers (even if crated) as they contain devices and mechanisms which may be damaged by rough handling.
5. Only authorized personnel should be permitted to operate or service the controller.
6. This equipment generates, uses, and can radiate radio frequency energy and if not installed and used in accordance with the instruction manual, may cause interference to radio communications. Operation of this equipment in a residential area is likely to cause interference in which case the user at his own expense will be required to take whatever measures may be required to correct the interference.

DANGER

HAZARD OF ELECTRICAL SHOCK OR BURN BEFORE SERVICING, TURN OFF POWER SUPPLY(S) TO THIS EQUIPMENT. WAIT 5 MINUTES. MEASURE CAPACITOR VOLTAGES TO VERIFY THAT THEY ARE ZERO. DO NOT SHORT ACROSS CAPACITORS WITH VOLTAGE PRESENT.

The dc bus capacitors are discharged slowly when input power is removed from the OMEGAPAK controller. To ensure the capacitors are fully discharged, always test with a dc voltmeter (1000vdc scale) before doing any wiring, troubleshooting or work inside the controller enclosure. If no reading is shown on the voltmeter, reduce scale and test again.

If the capacitors are not fully discharged in 5 minutes, contact Square D — *Do not operate the controller.*

DANGER

HAZARD OF ELECTRICAL SHOCK OR BURN MANY PARTS, INCLUDING ELECTRONIC PRINTED WIRING BOARDS, IN THIS CONTROLLER OPERATE AT LINE VOLTAGE. DO NOT TOUCH. USE ONLY ELECTRICAL INSULATED TOOLS WHILE MAKING ADJUSTMENTS.

CAUTION

DO NOT CHANGE THE POSITION OF ANY PRINTED WIRING BOARD SWITCH OR REMOVE ANY PRINTED WIRING BOARD WITH THE DRIVE RUNNING. TO DO SO MAY CAUSE AN EQUIPMENT MALFUNCTION.

1.2 PRELIMINARY INSPECTION

Inspect for shipping damage upon receiving the OMEGAPAK controller. If any shipping damage is found, immediately notify the freight carrier and your Square D representative. Open the door on the controller and check inside for any visual damage. **DO NOT ATTEMPT TO OPERATE THE CONTROLLER IF ANY VISUAL DAMAGE IS NOTED.** All printed wiring boards should be in place and secure. Check all connectors to be sure they are locked and securely in place.

1.3 STORAGE

After the preliminary inspection repack and store the OMEGAPAK controller in a clean dry location. **DO NOT** store this equipment in any area where the ambient temperature will rise above 60°C (140°F) or go below — 17°C (0°F). **DO NOT** store this equipment in high condensation or corrosive atmospheres. Proper storage is required to prevent equipment damage.

1.4 CONTROLLER IDENTIFICATION

The 50-125 HP OMEGAPAK adjustable frequency controller is a combination (with molded case switch and current limiting fuses) controller. The controller can be supplied in a wall mounted enclosure (OMEGAPAK 1500) or a floor mounted enclosure (OMEGAPAK 3500).

The OMEGAPAK 3500 controller enclosure provides space for one or two OMEGAPAK 1500 open controllers depending upon options selected. Optional power and standard ground bus enables the OMEGAPAK 3500 controller to become an integral part of a Square D Model 4 motor control center line-up.

The nameplate for the OMEGAPAK 1500 open controller is located on the inside surface of the electronics door. This nameplate is described in Figure 1.1 and carries the 1500 controller class, type and MOD (options) listing. When identifying 1500 controllers use the data from this nameplate.

The main nameplate for the 3500 controller is located on the outside of the controller enclosure. This nameplate is described in Figure 1.2 and carries the 3500 controller class, type and MOD (options) listing in addition to the factory order number and bus rating if optional power bus is furnished. When identifying 3500 controllers use the data from this nameplate.

To aid in identifying the controller, refer to Figure 1.3 & 1.4 for nameplate identification codes. When the controller has been defined, refer to the appropriate section of this service bulletin.

FIGURE 1.1

1500 CONTROLLER NAMEPLATE

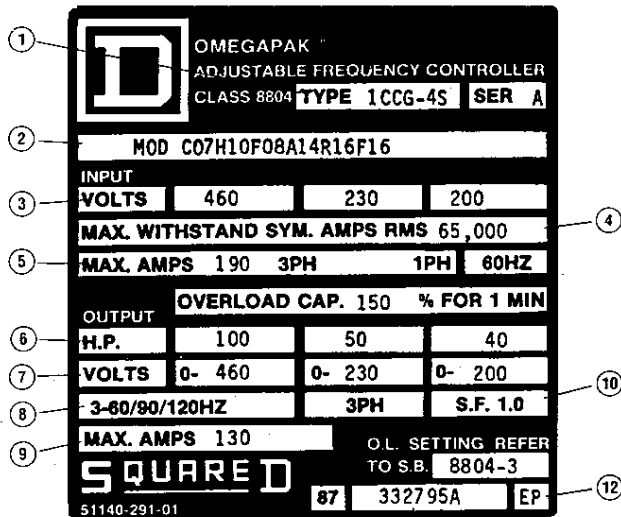

1500 CONTROLLER NAMEPLATE
(LOCATED INSIDE THE DOOR)

- | | |
|---|----------------------------------|
| 1. CONTROLLER TYPE CODE* | 7. OUTPUT VOLTAGES |
| 2. OPTIONS (MOD) CODE** | 8. OUTPUT FREQUENCY |
| 3. PERMISSIBLE INPUT VOLTAGES | 9. MAX. OUTPUT RATED CURRENT |
| 4. MAX. WITHSTAND SYM. AMPS. RMS | 10. SERVICE FACTOR OF CONTROLLER |
| 5. MAX. INPUT RATED CURRENT*** | 11. FACTORY ORDER NUMBER |
| 6. HORSEPOWER RATINGS AT INPUT VOLTAGES | 12. DATE CODE |
- * SEE FIGURE 1.3.
** SEE FIGURE 1.4.
***SEE SECTION 2.0, FIGURE 2.3

FIGURE 1.2

3500 CONTROLLER NAMEPLATE

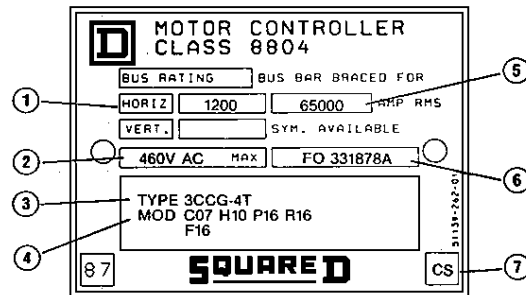

3500 CONTROLLER NAMEPLATE
(LOCATED OUTSIDE THE ENCLOSURE)

- | | |
|--------------------------------------|--|
| 1. HORIZONTAL BUS RATING | 5. HORIZONTAL BUS BAR SHORT CIRCUIT RATING |
| 2. PERMISSIBLE MAXIMUM INPUT VOLTAGE | 6. FACTORY ORDER NUMBER |
| 3. CONTROLLER TYPE CODE* | 7. DATE CODE |
| 4. OPTIONS (MOD) CODE** | * SEE FIGURE 1.3. |
| | ** SEE FIGURE 1.4. |

FIGURE 1.3
IDENTIFICATION CODE

CLASS 8804, TYPE					-4
STYLE CONTROLLER					
1500	1				
3500	3				
HORSEPOWER RANGE					
50-125 @ 460V		C			
CONTROLLER SYSTEM					
BASIC CONSTANT TORQUE CONTROLLER			C		
VARIABLE TORQUE RATED			V		
TYPE ENCLOSURE					
OPEN TYPE				O	
NEMA 12				A	
NEMA 1				G	
RATING OF CONTROLLER @ 460V					
50 HP					P
60 HP					Q
75 HP					R
100 HP					S
125 HP (AVAILABLE VARIABLE TORQUE ONLY)					T

1.5 KITS FOR FIELD INSTALLATION

Controller modifications are available in kit form. Each kit contains necessary hardware and installation instructions.

Description	Kit Number	Kit Installation Instructions	Description	Kit Number	Kit Installation Instructions
Isolated Option Board ^①	Class 8804, Type MC-12	50006-021-01	Speed Meter, Voltmeter or Ammeter (Digital) ^②	Class 8804, Type DM-1	50006-020-01
Non-Isolated Option Board With Run Relay ^①	Class 8804, Type MC-14	50006-021-01	Dynamic Braking ^③	Class 8804, Type DB-66 & DB-67	50006-024-01
Non-Isolated Option Board ^①	Class 8804, Type MC-11	50006-021-01	Control Cable Assembly ^④	Class 8804, Type CK-16	50006-018-01
Pneumatic Option Board ^①	Class 8804, Type MC-13	50006-021-01	^① Refer to Section 3.2.1 for Option Board Functions. ^② Open type. For remote mounting or as replacement device in 1500/3500 controllers. ^③ Includes DB module and an enclosed resistor for remote mounting. ^④ Twelve conductor cable for wiring controller mounted pilot devices.		
Speed Meter (Analog) ^②	Class 8804, Type AM-1	50006-020-01			
Voltmeter (Analog) ^②	Class 8804, Type AM-2	50006-020-01			
Ammeter (Analog) ^②	Class 8804, Type AM-3	50006-020-01			

**FIGURE 1.4
IDENTIFICATION CODE**

(OPTIONS) MOD

OPTION BOARD ①									
NON-ISOLATED	A07								
NON-ISOLATED W/ RUN RELAY	B07								
ISOLATED	C07								
PNEUMATIC	D07								
RELAYS									
DRIVE FAIL RELAY	F08②								
AUX. SEQ. RELAY NO. 1	T08③								
AUX. SEQ. RELAY NO. 2	S08③								
DRIVE FAIL RELAY & AUX. SEQUENCE RELAY NO. 1	A08③								
DRIVE FAIL RELAY & AUX. SEQUENCE RELAY NO. 2	B08③								
AUXILIARY SEQUENCE RELAYS NO. 1 & NO. 2	C08③								
DRIVE FAIL RELAY & AUX. SEQ. RELAYS NO. 1 & 2	D08③								
DYNAMIC BRAKING									
DB RESISTORS, SEPARATELY MOUNTED		D09							
GENERAL PURPOSE PILOT DEVICES									
START-STOP, MANUAL SPEED POTENTIOMETERS			S10						
HAND-OFF-AUTO, MANUAL SPEED POTENTIOMETER			H10②						
HAND-AUTO, START-STOP, MANUAL SPEED POTENTIOMETER			A10②						
FAST STOP, START-STOP, MANUAL SPEED POTENTIOMETER			F10						
SPECIAL PURPOSE PILOT DEVICES									
FORWARD-REVERSE SELECTOR SWITCH				F11					
RUN-JOG SELECTOR SWITCH				J11④					
FORWARD-REVERSE, RUN-JOG SELECTOR SW.				B11④					
POWER BUS									
600A BUS (1/4X2 AL/SN)					A12				
600A BUS (1/4X2 CU/SN)					B12				
600A BUS (1/4X2 CU/AG)					E12				
800A BUS (1/4X3 AL/SN)					F12				
1000A BUS (1/4X3 CU/SN)					G12				
1000A BUS (1/4X3 CU/AG)					H12				
1000A BUS (1/4X4 AL/SN)					J12				
1000A BUS (2-1/4X2 AL/SN)					K12				
1200A BUS (2-1/4X2 CU/SN)					L12				
1200A BUS (2-1/4X2 CU/AG)					M12				
1200A BUS (1/4X4 CU/SN)					N12				
1200A BUS (1/4X4 CU/AG)					P12				
1200A BUS (2-1/4X3 AL/SN)					Q12				
1400A BUS (2-1/4X4 AL/SN)					R12				
1600A BUS (2-1/4X3 CU/SN)					S12				
1600A BUS (2-1/4X3 CU/AG)					T12				
1800A BUS (2-1/4X4 CU/SN)					U12				
1800A BUS (2-1/4X4 CU/AG)					V12				
CONTACTORS									
OUTPUT ISOLATION						C13⑤	⑤		
BY-PASS AND ISOLATION WITH CIRCUIT BREAKER STARTER						B13⑤	⑤		
BY-PASS AND ISOLATION WITH FUSIBLE SWITCH STARTER						D13⑤	⑤		
METERING, SPEED-FREQUENCY									
ANALOG SPEED INDICATOR								A14	
DIGITAL SPEED/FREQUENCY INDICATOR								D14	
ADDITIONAL METERING									
ELAPSED TIME METER									T15
ANALOG VOLT-METER									V15
ANALOG AMMETER									A15
ANALOG AMMETER & VOLT-METER									B15
ANALOG VOLT-METER & ELAPSED TIME METER									C15
ANALOG AMMETER & ELAPSED TIME METER									D15
ANALOG AMMETER, VOLT-METER & ELAPSED TIME METER									E15
DIGITAL VOLT-METER									F15
DIGITAL AMMETER									G15
DIGITAL AMMETER & VOLT-METER									H15
DIGITAL VOLT-METER & ELAPSED TIME METER									J15
DIGITAL AMMETER & ELAPSED TIME METER									K15
DIGITAL AMMETER, VOLT-METER & ELAPSED TIME METER									L15
PILOT LIGHTS									
POWER ON LIGHT									P16
RUN LIGHT									R16
DRIVE FAIL LIGHT									F16②
INCOMPLETE SEQUENCE LIGHT									S16③

- ① Refer to Section 3.2.1 for Option Board Functions.
- ② Requires the addition of Option Board MOD A07, B07, C07 or D07.
- ③ Requires the addition of Option Board MOD B07, C07, or D07, with MOD A08.
- ④ Requires the addition of Option Board MOD A07, B07, C07 or D07 for "JOG AT PRESET SPEED". "JOG AT SET SPEED" is standard.
- ⑤ Available for OMEGAPAK 3500 controllers only.

2.0 INSTALLATION

2.1 MECHANICAL INSTALLATION

The OMEGAPAK controller is mounted in a dusttight, oil tight NEMA 12 or general purpose NEMA 1 enclosure. It is suitable for use in normal industrial environments:

Temperature range of 0°C to 40°C (32°-104°F)

Humidity range of 0% to 95% maximum non-condensing

Altitude to 3300 ft. above sea level

Do not mount the OMEGAPAK controller in direct sunlight or on hot surfaces. The controller must be mounted vertically to allow for proper ventilation. When drilling for conduit entry, care must be exercised to prevent metal chips from falling on parts and electronic printed wiring boards. Mounting dimensions, conduit entry areas and controller weights are located in Section 11.0 of this service bulletin.

Wall mounted controllers must be securely attached to the mounting surface. The mounting arrangement and surface must be capable of supporting a weight of approximately 350-400 pounds.

Floor mounted controllers should be located on a concrete pad or equivalent and secured firmly in place using mounting holes provided in bottom channels of the enclosure. Adequate clearance must be provided to permit the door(s) to be fully opened for easy access.

LIFTING INSTRUCTIONS — FLOOR MOUNTED CONTROLLERS

The following instructions are provided to assist in the avoidance of personal injury and equipment damage during movement of the controller.

1. Use extra caution and very sound safety practice while moving the controller.
2. Exercise extreme care when lifting or lowering the controller using a fork lift truck or equivalent. Prevention of damage or injury due to dropping or jolting this equipment should be strictly observed.
3. When lifting enclosures, use an I beam sling or spreader bar as shown in illustration to prevent distortion of the cabinet.

CAUTION

DO NOT PASS ROPES OR CABLES
THRU LIFT HOLES; USE SLINGS
WITH SAFETY HOOKS OR SHACKLES.

ATTACH SPREADER BAR
KEEP LIFTING FORCE VERTICAL (SEE ILLUSTRATION)

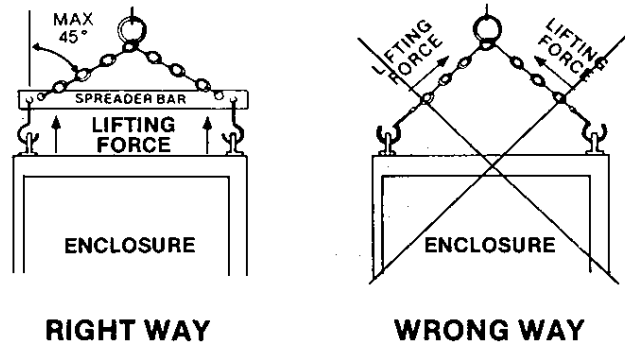

2.2 ELECTRICAL INSTALLATION

DANGER
HAZARD OF ELECTRICAL SHOCK OR BURN
TURN OFF POWER (MAIN AND REMOTE)
PRIOR TO INSTALLING THIS EQUIPMENT

2.2.1 INPUT POWER

The OMEGAPAK controller operates from three phase 460/230/200vac, + 10% - 5%, 60/50 Hertz, connected to the input disconnect switch. Current limiting fuses are installed in the controller input. These fuses are coordinated with the controller power circuit for a fault withstand capability of 65,000 RMS symmetrical amperes maximum.

The controller is factory set for 460vac, 60 Hertz input power. If the controller is connected to operate from 230vac, 200vac or 50 Hertz power, refer to the initial start-up procedure (Section 5.0) described in this service bulletin.

2.2.2.A INPUT WIRING

The ampacity of power conductors feeding the OMEGPAK controller should be sized for the maximum input currents listed in Figure 2.1, the National Electrical Code and applicable local electrical codes. Refer to Figure 2.5 for lug data and maximum wire size.

FIGURE 2.1

MAXIMUM CONTROLLER INPUT AND OUTPUT RATED CURRENTS				
MAXIMUM HORSEPOWER			INPUT AMPERES^①	MAXIMUM CONTINUOUS RATED OUTPUT AMPERES
200V	230V	460V		
20	25	50	97	68
25	30	60	116	80
30	40	75	142	104
40	50	100	190	130
50 ^②	60 ^②	125 ^②	230	156

- ① Input currents are maximum values expected. Actual current values could be less depending on the power input source impedance.
- ② Variable torque loads only

For safe operation, the controller must be grounded. A ground lug is provided in wall mounted controllers and ground bus is provided in floor mounted controllers. See Section 2.2.2.C for ground bus splicing instructions.

DANGER
HAZARD OF ELECTRICAL SHOCK OR BURN
CONTROLLER PANEL MUST BE PROPERLY GROUNDED BEFORE APPLYING POWER.

Input wiring for wall mounted controllers or floor mounted controllers without power bus should be connected to lugs on the bottom of the controller disconnect switch. Lugs provided on the switch will accept one #4 AWG-300 MCM Copper or aluminum wire per phase. Wire binding screws should be tightened to 250 lb.-in. Two-high controllers or controllers with the bypass and isolation contactor option will have main power terminals located in the power bus area at the top of the enclosure. Use of normal flexibility stranded conductors is recommended. High flexibility conductors with many fine strands should be avoided due to the increased possibility of a poor termination. Some floor mounted controllers may be equipped with horizontal power bus. In controllers so equipped, wiring from the disconnect switch to the horizontal bus will have been factory installed. It will be necessary to connect the controller power bus to the power bus in other equipment using splice bars furnished. Follow the procedure detailed in Section 2.2.2.B.

2.2.2.B POWER BUS INSTALLATION
 (OMEGAPAK 3500 controllers only)

To gain access to the power bus, open the power bus compartment door (Refer to Section 4.0 Controller Photos). Install splice bars per Figure 2.2A for single bus bars per phase or Figure 2.2B for dual bus bars per phase. Install the bus barrier plate and close and secure bus compartment door.

DANGER
HAZARD OF ELECTRICAL SHOCK OR BURN
BEFORE SPLICING TO EXISTING APPARATUS, DISCONNECT ALL POWER TO BUS OF EXISTING EQUIPMENT. DO NOT ATTEMPT TO WORK WHILE EXISTING EQUIPMENT IS ENERGIZED.

FIGURE 2.2
POWER BUS — SPLICE BAR INSTALLATION

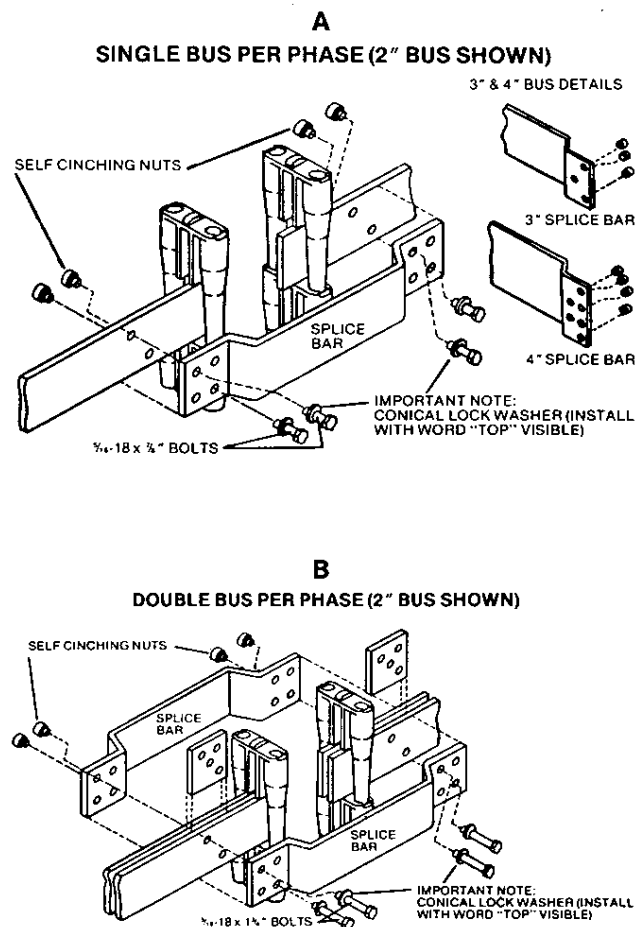

2.2.2.C GROUND BUS INSTALLATION

(OMEGAPAK 3500 controllers only)

If an adjustable frequency controller is not installed in the bottom compartment of the OMEGAPAK 3500 cabinet, follow Step 2 only.

1. Remove the four mounting screws at the bottom of the heat sink fans. Slide the fans out far enough to access the power connector. Unplug the power cords and remove the fans. (See section 4, controller photos)

Remove the screws holding the bottom fan mounting bracket in place and remove the bracket to gain access to the ground bus.

2. Install the ground bus splice bar(s) provided (See Figure 2.3).
3. Reverse the procedure in Step A to reassemble the controller.

**FIGURE 2.3
GROUND BUS — SPLICE BAR
INSTALLATION**

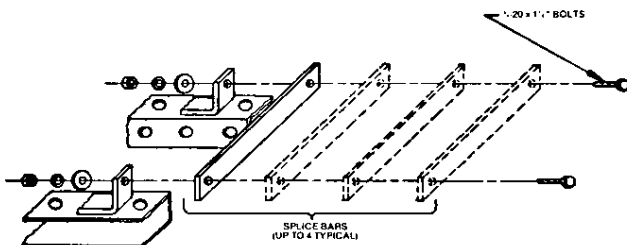

2.2.3 OUTPUT POWER

The output voltage is proportional to the output frequency to provide a constant Volts/Hertz ratio in the 20 to 60 Hertz operating range. Below 20 Hertz the Volts/Hertz ratio will vary depending on the setting of the voltage boost potentiometer.

The ampacity of motor power conductors should be sized according to the motor full load current, National Electrical Code and applicable local electrical codes.

Connect motor conductors to the lugs provided. Refer to Section 4 controller photos for lug location. Refer to Figure 2.5 for data on lugs and maximum wire size.

Do not connect the output terminals of the controller (T1, T2, or T3) to the L1, L2, or L3 controller terminals or to any other source

of voltage. To do so will cause controller damage. Should it become necessary to bypass a controller not equipped with an iso-bypass option, the customer connections to the controller T1, T2, and T3 terminals must be disconnected to prevent back feeding the controller.

If a customer supplied isolating device is installed between the controller output and the motor (e.g. isolation contactor), the isolating device must not be switched to the open position and then back to the closed position, unless sufficient time is allowed for the motor open-circuit voltage to decay to less than 10% of the motor nameplate rated voltage. Re-connecting the motor to the operating controller without allowing the motor terminal voltage to decay may cause controller damage. When multiple motors are operated from one controller, several critical requirements must be met to assure proper controller and motor operation.

1. Individual motor overload protection must be provided in accordance with the National Electrical Code or applicable local codes.
2. The total of the connected motor nameplate load currents, as seen by the controller, must not exceed the controller rated output current.
3. If one or more of the motors are to be connected or disconnected from the controller while the controller is operating, the following conditions *must be met*.
 - A) The motor isolating device must not allow reconnection of the motor to the controller without first allowing the motor open-circuit voltage to decay to less than 10% of the motor nameplate rated voltage.
 - B) The summation of the running currents of the connected motors and the locked rotor current of the motor(s) being reconnected to the controller must be less than 130% of the controller rated output current for constant torque rated controllers (110% controller rated output current for variable torque controllers).

2.2.4 CONTROL WIRING

If the OMEGAPAK controller does not have pilot devices mounted in the door cover, refer to Section 11.5 for wiring of remote control operators station. Refer to Figure 2.5 for data on maximum wire size.

NOTE: All remote Manual Speed potentiometers must be wired with insulated shielded cable. One end of the shield must be grounded at the controller per the wiring diagram. The other end must be insulated from ground and **unconnected**.

If an option board was supplied with the controller for automatic operation, refer to Section 11.6.1 thru 11.6.4 for wiring of analog follower input signals.

When wiring external control devices to the controller's sequencing circuitry the following guidelines should be considered:

Pilot Devices (push buttons, selector switches, relay contacts, etc.) — The maximum distance from the controller to an external pilot device is limited by the dc resistance of the wiring plus the remote device contact resistance and the leakage capacitance between the conductors. Wire size must be selected such that the maximum circuit resistance (wire plus remote contact) does not exceed 10.5 ohms. Higher resistance may result in failure to deliver sufficient voltage to pick up the controller sequencing relays. Maximum leakage capacitance of installed wire must not exceed 1.4 microfarads. Higher leakage capacitance may prevent the controller sequencing relays from dropping out.

Solid State Contacts — Many solid state control devices, such as programmable controllers, use solid state switches (Triacs) in the output stages. In addition to criteria stated above for resistance and leakage capacitance, the off state resistance must limit leakage current (with 24v applied) to not more than 3 ma.

OMEGAPAK Controller Relays — Some relays in the controller have extra contacts available for controlling the remote devices. These contacts are rated as described in Figure 2.4.

FIGURE 2.4

MAXIMUM ELECTRICAL RELAY CONTACT RATINGS

Contact Material	AC Amperes					HP	DC Amperes			
	AC Volts	Inductive 35% P.F.			Res. 75% P.F. Make Break & Continuous		DC Volts	Inductive		Res. Make Break & Continuous
		Make	Break	Con- tinuous				Make	Break	
Silver Cadmium Gold Flashed	120	15	1.5	5 ①	5 ①	1/10	28	1.5	1.5	5

① Limited by printed wiring board foil to 3 amperes continuous.

NOTE: To avoid electrical noise problems and nuisance tripping of the adjustable frequency controller, all remote controlled inductive loads (relay coils, contactor coils, solenoids, etc.) must be transient suppressed.

2.2.5 WIRING PRACTICE

Good wiring practice requires that control circuit wiring be separated from all power wiring (whether from the same controller, or other controllers). This minimizes the possibility of electrical transients being electrostatically or electromagnetically coupled into the control circuits from the power circuits.

1500 Controllers — Open Type

Open type controllers are intended for mounting in 1500 or 3500 enclosures only. Refer to 1500 or 3500 enclosed controllers for proper wiring practice.

1500 Controllers — Enclosed Type

Enclosed controllers are intended to be wired using conduit. Metallic conduit is preferred but non-metallic conduit is acceptable if a grounding circuit conductor is supplied. Control and power wiring must never be run in a common conduit.

3500 Controllers

All wiring recommendations for 1500 controllers should be followed. In addition, an interconnection diagram may be furnished with 3500 controllers and should be consulted for special wiring requirements.

**FIGURE 2.5
LUG & MAXIMUM WIRE SIZE TABLE**

Application	Number Conductors	Wire Size		Tightening Torque
		Min.	Max.	
Incoming Power ^①	1	4AWG	300MCM	250 lb-in
Output Power (Motor)	2	8AWG	2/0AWG	140 lb-in
Control Circuit (Main Control Board & Options Board)	1	N/A	12AWG	7 lb-in
	or 1	N/A	14AWG	
	or 2	N/A	16AWG	
	or 3	N/A	18AWG	
	or 5	N/A	20AWG	
GROUND 1500 Controller	1	8AWG	2AWG	90 lb-in
		3500 Controller Ground Bus		
Dynamic Braking Module	1			90 lb-in
Dynamic Braking Resistor	1	8AWG	2AWG	100 lb-in
Isolation or Bypass & Isolation Contactor	1	50-100 HP	00AWG 250MCM	200 lb-in
		125 HP	00AWG 350MCM	
Incoming ^② Power	2	4AWG	350MCM	275 lb-in

① Used for 1500 controllers and single 3500 controllers without bypass and isolation.

② Used for dual 3500 controllers or single 3500 controllers with bypass and isolation

3.0 APPLICATION DATA

3.1 BASIC CONTROLLER

3.1.1 INPUT

Voltage 200/230/460vac +10%,
-5%

Frequency 50/60 Hertz

Maximum Continuous Input Current -
See Section 2.0, Figure 2.1

Three Phase Phase Rotation
Only Insensitive

Displacement .95 lagging @ rated load

Power Factor

Control Power 24vac and 24vdc

Relays 12vdc

Pilot Lights 24vac (Full Voltage Only)

3.1.2 OUTPUT

Frequency 1.25 to 60 Hertz, select-
able 1.25 to 90 Hertz or
1.25 to 120 Hertz

Voltage 0 to 200vac, 0 to 230vac,
0 to 460vac, three phase

Waveform Sine coded PWM (Pulse
Width Modulated)

Maximum Continuous Output Rated
Current - See Section 2.0, Figure 2.1

Short Time 150% of maximum contin-
uous output rated
Overload current for 60 seconds.
(120% for variable
torque controllers).

Starting 175% of maximum contin-
uous output rated
Current current for 1/2 second or
until output frequency
reaches 5 Hertz. (140%
for variable torque
controllers).

OUTPUT SIGNALS

Current 0 to 5vdc proportional to
output current, 5vdc
equals 150% of maxi-
mum continuous output
current (120% for vari-
able torque controllers).

Voltage 0 to 5vdc proportional to
the fundamental output
voltage, 4vdc equals 460
output voltage.

Frequency 0 to 5vdc proportional to
output frequency/motor
speed, 2.5vdc equals
selected Hertz/motor
base (rated) speed.

Relay Form C contacts rated 5
Contacts amperes@ resistive at
115v ac maximum.

3.1.3 PERFORMANCE

Controller Linearity (Percent of F_{Base})

	F _{Base} = 60 Hz	F _{Base} = 90 Hz	F _{Base} = 120 Hz
OFC Pot Disabled:			
Hand Input [Ⓞ]	±.25 Typ.	±.25 Typ.	±.25 Typ.
Auto Input (A07)	±1.1 Typ.	±1.1 Typ.	±1.1 Typ.
Auto Input (B07)	±1.1 Typ.	±1.1 Typ.	±1.1 Typ.
Auto Input (C07)	±1.2 Typ.	±1.2 Typ.	±1.2 Typ.
Auto Input (D07)	±5.0 Typ.	±5.0 Typ.	±5.0 Typ.
OFC Pot Enabled:			
Hand Input [Ⓞ]	±.05 Typ., ±.2 max.	±.05 Typ., ±.2 max.	±.05 Typ., ±.2 max.
Auto Input (A07)	±1.5 max.	±1.5 max.	±1.5 max.
Auto Input (B07)	±1.5 max.	±1.5 max.	±1.5 max.
Auto Input (C07)	±1.5 max.	±1.5 max.	±1.5 max.
Auto Input (D07)	±7.5 max.	±7.5 max.	±7.5 max.
Frequency Stability At 25°C Ambient	±.55 Hz Max.		
Frequency Shift With Ambient Temperatures:			
Hand Input	±.01 Hz/°C Typ., ±.015 Hz/°C max.		
Auto Input (A07)	±.01 Hz/°C Typ., ±.015 Hz/°C		
Auto Input (B07)	±.01 Hz/°C Typ., ±.015 Hz/°C		
Auto Input (C07)	±.07 Hz/°C Typ., ±.15 Hz/°C		
Auto Input (D07)	±.15 Hz/°C Typ., ±.30 Hz/°C		

[Ⓞ] W/O Options Board Installed

Speed NEMA Design B induc-
Regulation tion motor ±0.5% of
base operating speed
with slip compensation.
Applicable only while
operating motor in fre-
quency range for which
constant motor torque is
possible.

Current Limit Adjustable 75% to
150% of maximum contin-
uous output rated
current (60% to 120%
for variable torque
controllers).

3.1.4 ENVIRONMENTAL CONDITIONS

Storage -17°C to 60°C (0°F to
Temperature 140°F)

Operating Enclosed 0° to 40°C
(Ambient) (32°F to 104°F) Open
Temperature 0°C to 40°C (32°F to
104°F)

Altitude To 1,000 meters (3,300
feet) w/o derating

Relative To 95% maximum
Humidity non-condensing

3.1.5 ADJUSTMENTS

Current Limit	Adjustable 75-150% of maximum continuous output rated current (60-120% for variable torque controllers).
Voltage Boost	Adjustable 100% to 600% of nominal Volts/Hertz ratio. This boost is fully effective at 1.25 Hertz and tapers to zero boost at 20 Hertz.
Output Frequency Range	Extended frequency operation to 90 Hertz or 120 Hertz.
Maximum Frequency	Adjustable 40 Hertz to maximum selected operating frequency.
Minimum Frequency	Adjustable 1.25 Hertz to 50% of maximum adjusted operating frequency.
Acceleration/Deceleration Time Range	Range selection switch for 1 to 10 seconds or 10 to 60 seconds for 60 Hertz maximum operating frequency. (Range times 1.5 for 90 Hertz or times 2 for 120 Hertz maximum operating frequency).
Acceleration Time	Adjustable over selected range.
Deceleration Time	Adjustable over selected range.
Slip Compensation	Adjustable 0% to 3% of base operating frequency from no load to full load.
Overload Threshold	Adjustable 0% to 115% of maximum continuous output rated current.
Input Voltage	200vac, 230vac or 460vac operation.
Input Frequency	The controller is factory set to operate from 60 Hertz power. Adjustable for operation from a 50 Hertz power source.
System/Motor Voltage	Selection for base output voltage at base fre-

quency to match base input voltage or 1/2 base output voltage at base frequency to permit extended constant torque frequency range.

Response to Option Fault

Selection for controller shutdown and LED illumination or LED illumination only upon a fault condition occurring on an Option Board, Dynamic Braking Unit or Regenerative Braking Controller.

One or Two Fault Lockout

The controller is factory set for lock-out (manual reset) after first protective circuit trip. Selectable automatic reset after first trip and lockout after second trip within 65 seconds of the first.

3.1.6 PROTECTION

Instantaneous Overcurrent Trip

Non-adjustable trip setting of 180% of peak maximum continuous output rated current.

Ground Fault

Non-adjustable trip setting of 27 amperes peak. Trips in 20 microseconds when current settings are exceeded.

Full Time Current Limit

Adjustable 75% to 150% of maximum continuous output rated current (60% to 120% for variable torque controllers). Constant Volts/Hertz ratio is maintained as frequency is reduced.

Over-temperature Overload

Thermostat mounted on heatsink.

Adjustable 0% to 115% of maximum continuous output rated current.

Overfrequency

Non-adjustable clamp limits output frequency to not more than 22% above maximum selected operating frequency.

- Decel. Ramp Modification Automatically extends deceleration ramp if dc bus voltage rises because of excessive regenerated energy. Deceleration ramp modification is automatically disabled if optional dynamic braking is used.
- Overvoltage Protects the controller against excessive dc bus voltage. Trips at 900vdc for 460vac systems or 450vdc for 200/230vac systems.
- Undervoltage Trips at 87.5% of rated input voltage. Automatically resets at 95% of rated input voltage.
- Shoot-Through Protects the controller against dc bus short circuits caused by missequencing of the inverter GTO switches.
- Input Fuses Three current limiting fuses provide coordinated protection of the controller power circuit for fault withstand capability of 65,000 RMS symmetrical amperes.

NOTE: A detailed description of the diagnostic and status indicators is located in Section 7.0.

3.2 OPTIONS

There are a number of factory and/or field installed options for the Class 8804 OMEGAPAK controller. To determine which options (if any) were factory installed, refer to the controller nameplate for the MOD alphanumeric listing.

3.2.1 OPTION BOARDS①

There are four (4) option boards available to accept various follower input signals for automatic speed control. Other operational functions are also included on the option boards. All option boards provide the following functions:

Mode Select Permits selection of Hand-Off-Auto, Hand-Auto logic or Run-Jog modes of operation. The motor speed is controlled by the manual speed potentiometer in the manual mode. With the appropriate option board installed, the motor speed will follow an external voltage, current or pneumatic signal in the auto mode. The Run/Jog mode is controlled by an external selector switch input.

Jog/Shutdown Adjustable jog speed when the jog at preset speed option is used. Also provides adjustment of the shutdown speed for pumping applications. Adjustable from 1.25 Hertz to 30% (Jog Speed) or 1.25 Hertz to 90% (Shutdown Speed) of maximum output frequency.

Relay Socket One socket for the drive fail relay.

3.1.7 DIAGNOSTIC AND STATUS INDICATORS

Light Emitting Diodes (LEDs) and a neon light are provided for the following:

- Undervoltage (UV)
- Overvoltage (OV)
- Ground Fault (GF)
- Instantaneous Overcurrent (IOC)
- Shoot Through (ST)
- Overtemperature (OT)
- Overload (OL)
- Overload Timer (OLT)
- Option Fault (OF)
- Drive Lockout (DL)
- + 10V Power Supply OK (+10V)
- 10V Power Supply OK (-10V)
- Motor Current Limit (MCL)
- Regen Current Limit (RCL)
- Regenerating (REG)
- Power Up Delay (PUD)
- Drive Enabled (DE)
- DC Bus Voltage (IL1)

MOD F08

Drive Fail Relay (DFR) Class 8501, Type RSD-14, 12vdc coil. Provides 1 form C contact to signal abnormal controller shut-down. Contact rated 5 amperes[Ⓢ] resistive at 115vac maximum.

timer controls the optional Auxiliary Sequence Relay No. 1 (ASR1).

MOD S08

Auxiliary Sequence Relay No. 2 (ASR2) Class 8501, Type RSD-14, 12vdc coil. Provides 1 form C contact to signal that the drive is running. Contact rated 5 amperes[Ⓢ] resistive at 115vac maximum.

MOD C07 (Kit Class 8804, Type MC-12)

ISOLATED OPTION BOARD — This option board provides a voltage/current follower function with Offset & Span adjustments, plus the following functions:

DC Current 1-5madc, 2-10madc, 4-20madc, 10-50 madc

DC Voltage/ DC Tachometer 0-10vdc,0-35vdc, 0-100vdc, 0-250vdc

AC Tachometer 0-10vac, 0-35vac, 0-100vac, 0-250vac

Signal/Loss Detector Detects loss of a live zero analog input signal and illuminates Fault LED on option board.

Rotation Direction Select Provides automatic selection of direction of rotation as a function of dc input signal polarity. Zero to + signal causes increasing speed in the forward direction and zero to – signal causes increasing speed in the reverse direction.

Solid State Run Relay Automatic start command for the controller from an external 4-33vdc signal.

Sequence Timing Relay Provides a selectable timing range. The timing range is switch adjustable in 10 second increments from 10 to 160 seconds. The sequence timer controls the optional Auxiliary Sequence Relay No. 1 (ASR1).

MOD T08

Auxiliary Sequence Relay No. 1 (ASR1) Class 8501, Type RSD-14, 12vdc coil. Operates in conjunction with the sequence timing relay. Provides 1 form C contact to signal that the starting sequence was not successfully completed within the allotted time. This relay is normally used to monitor external activity such as Output Contactors, Pump Check Valves, and etc. Contact rated 5 amperes[Ⓢ] resistive at 115vac maximum.

MOD A07 (Kit Class 8804, Type MC-11)

NON-ISOLATED OPTION BOARD - This option board provides a voltage follower function with Offset & Span adjustments. Will accept the following analog input signals:

DC Voltage 0-10vdc

MOD B07 (Kit Class 8804, Type MC-14)

NON-ISOLATED OPTION BOARD W/RUN RELAY - This option board provides a voltage follower function with Offset & Span adjustments, plus a solid state run relay. Will accept the following analog input signals:

DC Voltage 0-10vdc

Solid State Run Relay Automatic start command for the controller from an external 4-33vdc signal.

Sequence Timing Relay Provides a selectable timing range. The timing range is switch adjustable in 10 second increments from 10 to 160 seconds. The sequence

MOD D07 (Kit Class 8804, Type MC-13)

PNEUMATIC OPTION BOARD - This option board provides a pneumatic follower function plus a solid state run relay.

<p>Pneumatic</p>	<p>3 to 15 psig. Input connection 5MM (0.20") O.D. male tubing slip on connector. Maximum pressure input is 45 psig.</p>	<p>Stop Push Button</p>	<p>Class 9001, Type KR1R-H13 Class 9001, Type KN-302 Legend Plate</p>
<p>Solid State Run Relay</p>	<p>Automatic start command for the controller from an external 4-33vdc signal.</p>	<p>Fast Stop^④ Push Button</p>	<p>Class 9001, Type KR1R-H13 Class 9001, Type KN-399 (FAST STOP) Legend Plate</p>
<p>Sequence Timing Relay</p>	<p>Provides a selectable timing range. The timing range is switch adjustable in 10 seconds increments from 10 to 160 seconds. The sequence timer controls the optional Auxiliary Sequence Relay No. 1 (ASR1).</p>	<p>Manual Speed Potentiometer</p>	<p>Class 9001, Type K2107</p>
<p>3.2.2 DYNAMIC BRAKING (DB)</p>		<p>MOD H10</p>	
<p>MOD D09 (Kit Class 8804, Type DB-XX)</p>		<p>Hand-Off-Auto Selector Switch</p>	
<p>Dynamic braking provides a means of rapid deceleration or quick stopping by dissipating motor rotational energy as heat in the braking resistor. An electronic module with a gate turn-off thyristor (GTO) & resistor is included.</p>		<p>Class 9001, Type KS43B-H2 Class 9001, Type KN-360 Legend PLate</p>	
<p>3.2.3 CONTROLLER MOUNTED PILOT DEVICES^③</p>		<p>Manual Speed Potentiometer</p>	
<p>MOD A10</p>		<p>MOD S10</p>	
<p>Hand-Auto-Selector Switch</p>	<p>Class 9001, Type KS11B-H2 Class 9001, Type KN 340 Legend Plate</p>	<p>Start Push Button</p>	<p>Class 9001, Type KR1B-H13</p>
<p>Start Push Button</p>	<p>Class 9001, Type KR1B-H13 Class 9001, Type KN301 Legend Plate</p>	<p>Stop Push Button</p>	<p>Class 9001, Type KR1R-H13 Class 9001, Type KN-302 Legend Plate</p>
<p>Stop Push Button</p>	<p>Class 9001, Type KR1R-H13 Class 9001, Type KN302 Legend Plate</p>	<p>Manual Speed Potentiometer</p>	<p>Class 9001, Type K2107 MOD B11</p>
<p>Manual Speed Potentiometer</p>	<p>Class 9001, Type K2107</p>	<p>Forward-Reverse Selector</p>	<p>Class 9001, Type KS11B-H1 Class 9001, Type KN339 Legend Plate</p>
<p>MOD F10</p>		<p>Run-Jog Selector Switch</p>	<p>Class 9001, Type KS11B-H1 Class 9001, Type KN348 Legend Plate</p>
<p>Start Push Button</p>	<p>Class 9001, Type KR1B-H13 Class 9001, Type KN-301 Legend Plate</p>	<p>MOD F11</p>	
<p>MOD J11</p>		<p>Forward-Reverse Selector Switch</p>	
<p>Class 9001, Type KS11B-H1 Class 9001, KN-348 Legend Plate</p>		<p>Class 9001, Type KS11B-H1 Class 9001, Type KN339 Legend Plate</p>	

MOD F16

Drive Fail^⑤ Pilot Light Class 9001, Type KT35
 Class 9001, Type KN399
 (DRIVE FAIL)

MOD P16

Power On Pilot Light Class 9001, Type KP35
 Class 9001 KN338 Leg-
 end Plate

MOD R16

Run Pilot Light Class 9001, Type KT35
 Class 9001, Type KN324
 Legend Plate

MOD S16

Incomplete^⑥ Sequence Pilot Light Class 9001, Type KT35
 Class 9001, Type KN399
 (INCOMPLETE SE-
 QUENCE) Legend Plate

- ① For Option Board set-up procedure refer to Section 5.2 of this service bulletin.
- ② Limited by printed wiring board foil to 3 amperes continuous.
- ③ Refer to wiring diagram section of this service bulletin for terminal connections.
- ④ Fast Stop must not be used with two wire control or with automatic operation having a remote start contact.
- ⑤ Drive Fail Pilot Light Option requires a Drive Fail Relay (DFR).
- ⑥ Incomplete Sequence Pilot Light Option requires an Auxiliary Sequence Relay No. 1 (ASR1).

3.2.4 OUTPUT ISOLATION CONTACTOR

MOD C13

Square D Class 8502 Type S Contactor properly sized for controller maximum continuous output current. Includes a 200/230/460 - 120 volt control power transformer with 2 primary and one secondary fuse. Available with OMEGAPAK 3500 controllers only.

3.2.5 ISOLATION & BYPASS CONTACTORS

MOD B13 & S13

Includes isolation contactor mechanically and electrically interlocked with a full voltage combination starter to provide

emergency full speed operation in the event the controller is out of service, a transfer delay timer and an AFC-Bypass Selector Switch. NOTE: Combination starter does **not include** thermal overload heaters. Available with OMEGAPAK 3500 controllers only.

MOD B13 provides a circuit breaker type combination starter and MOD S13 provides a fusible switch type combination starter.

3.2.6 POWER AND GROUND BUS MOD A12 THROUGH T12.

Various combinations of power and ground bus are available to permit the OMEGAPAK 3500 controller to be arranged in a motor control center line-up. Power and ground bus matches that used in Square D Model 4 motor control centers.

3.2.7 METERS

The meters described below are available in kit form for remote mounting or factory installed in the controller.

MOD A14 (Kit Class 8804, Type AM-1)

Analog Speed Meter - 3-1/2 inch meter with indicating scale of 0-100% speed. This meter is connected to the Main Control Board. A 0-5vdc signal is used to drive this meter.

MOD D14 (Kit Class 8804, Type DM-1) ①

Digital Speed Meter - 3-1/2 inch meter selectable to indicate 0-100% speed or 0-1999 RPM (Maximum RPM indication is 1999). This meter is connected to the same terminal points as the analog meter (MOD A14) described above.

MOD T15

Elapsed Time Meter - 3-1/2 inch meter with indicating scale of 99999.9 hours maximum. This meter is connected to the Main Control Board (refer to wiring diagram section of this Service Bulletin).

MOD V15 (Kit Class 8804, Type AM-2)

Analog Voltmeter - 3-1/2 inch meter with indicating scale of 0-125% of rated output voltage. This meter is connected to the main control board. A 0-5 vdc signal drives this meter.

MOD F15 (Kit Class 8804, Type DM-1) ①

Digital Voltmeter - 3-1/2 inch meter adjustable to read 0-100.0% of rated output voltage. This meter is driven by the same 0-5 vdc signal as the analog voltmeter.

MOD A15 (Kit Class 8804, Type AM-3)

Analog Ammeter - 3-1/2 inch meter with indicating scale to read 0-150% of rated controller output current. This meter is connected to the main control board. A 0-5 vdc signal drives this meter.

MOD G15 (Kit Class 8804, Type DM-1) ①

Digital Ammeter - 3-1/2 inch meter adjustable to read 0-150.0% of rated controller output current. This meter is driven by the same 0-5 vdc signal as the analog ammeter.

3.2.8 REGENERATIVE BRAKING

Provides rapid deceleration or quick stopping capability similar to Dynamic Braking but by returning motor rotational energy to the ac line.

This option is available for separate mounting when used with the OMEGAPAK 1500 controller and can be mounted in the OMEGAPAK 3500 controllers.

- ① The Class 8804 Type DM-1 meter can be field adjusted to display speed, voltage or current.

4.0 CONTROLLER PHOTOS

4.1 OMEGAPAK 1500 CONTROLLER

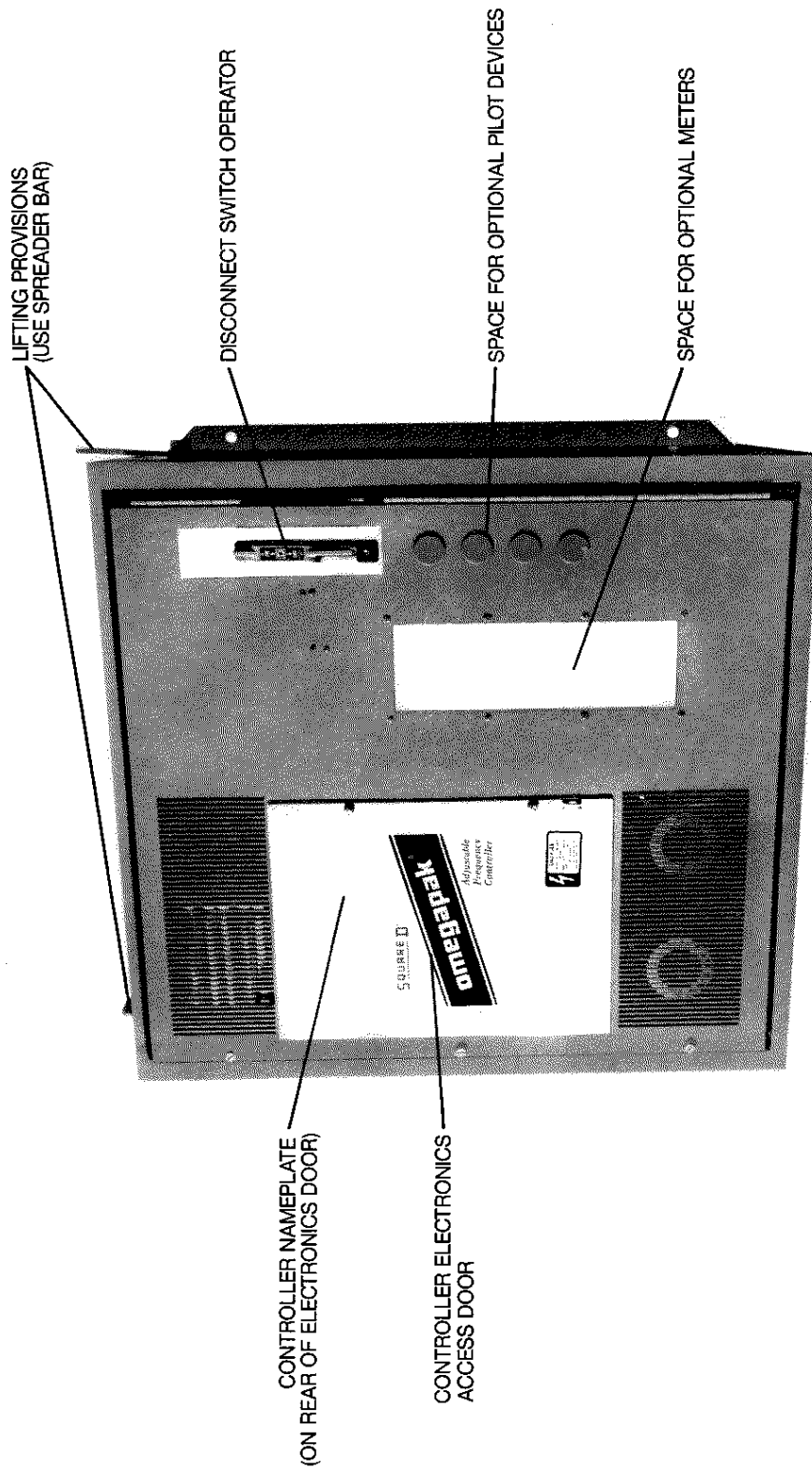

4.2 OMEGAPAK 3500 CONTROLLER — WITH ELECTRONICS DOOR OPEN

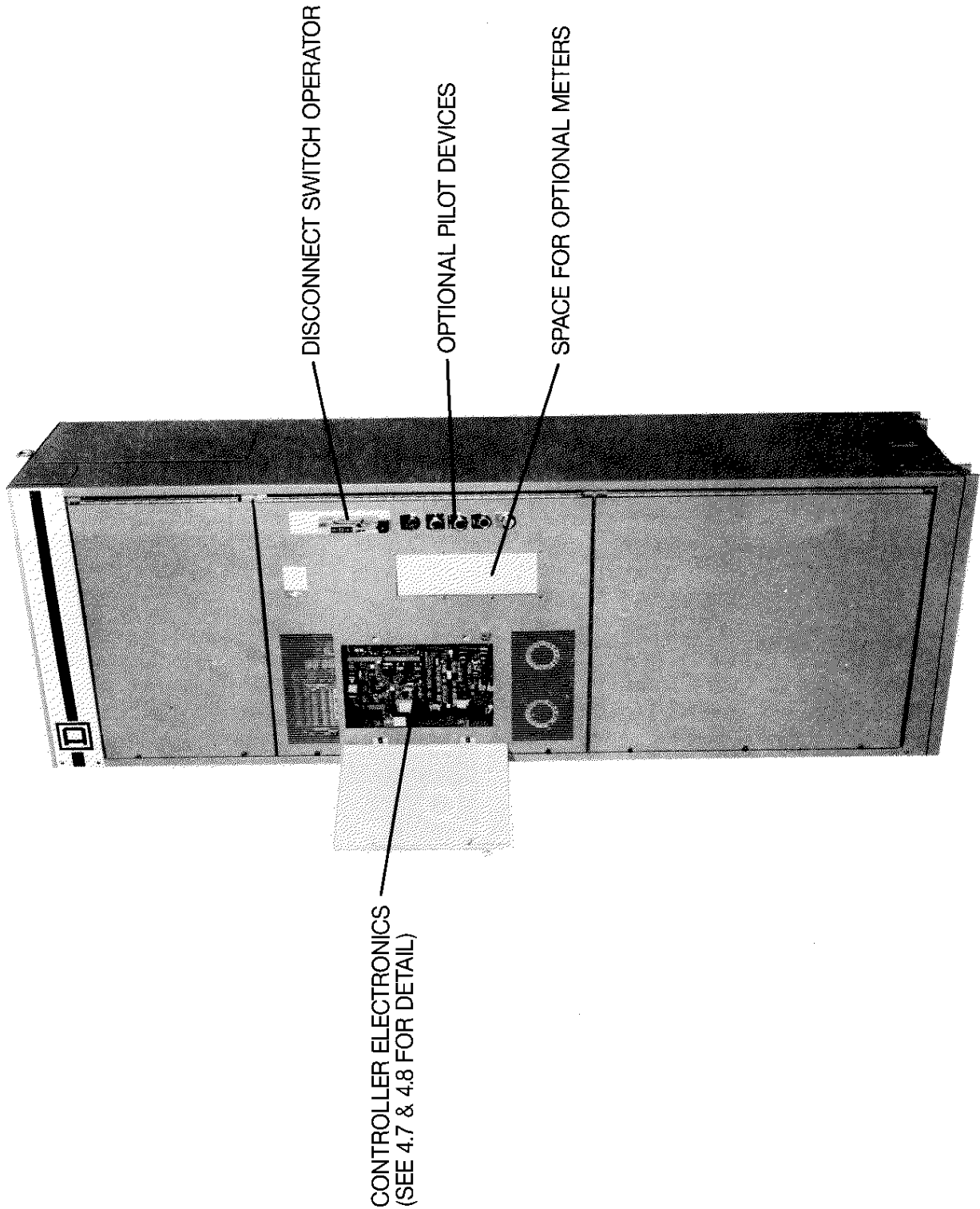

4.3 OMEGAPAK 3500 CONTROLLER — WITH MAIN DOOR OPEN

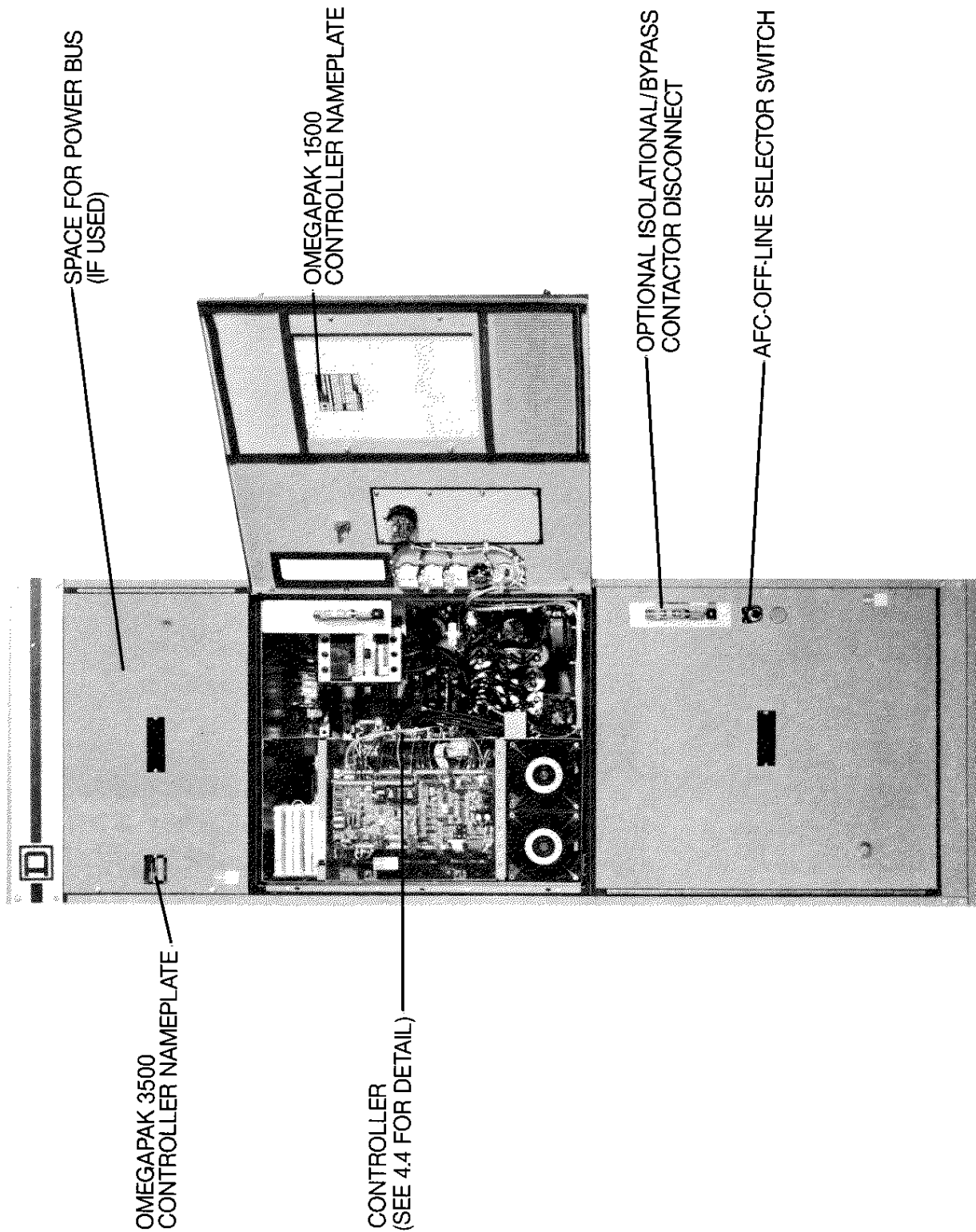

4.4 CLOSE-UP OF CONTROLLER INSIDE

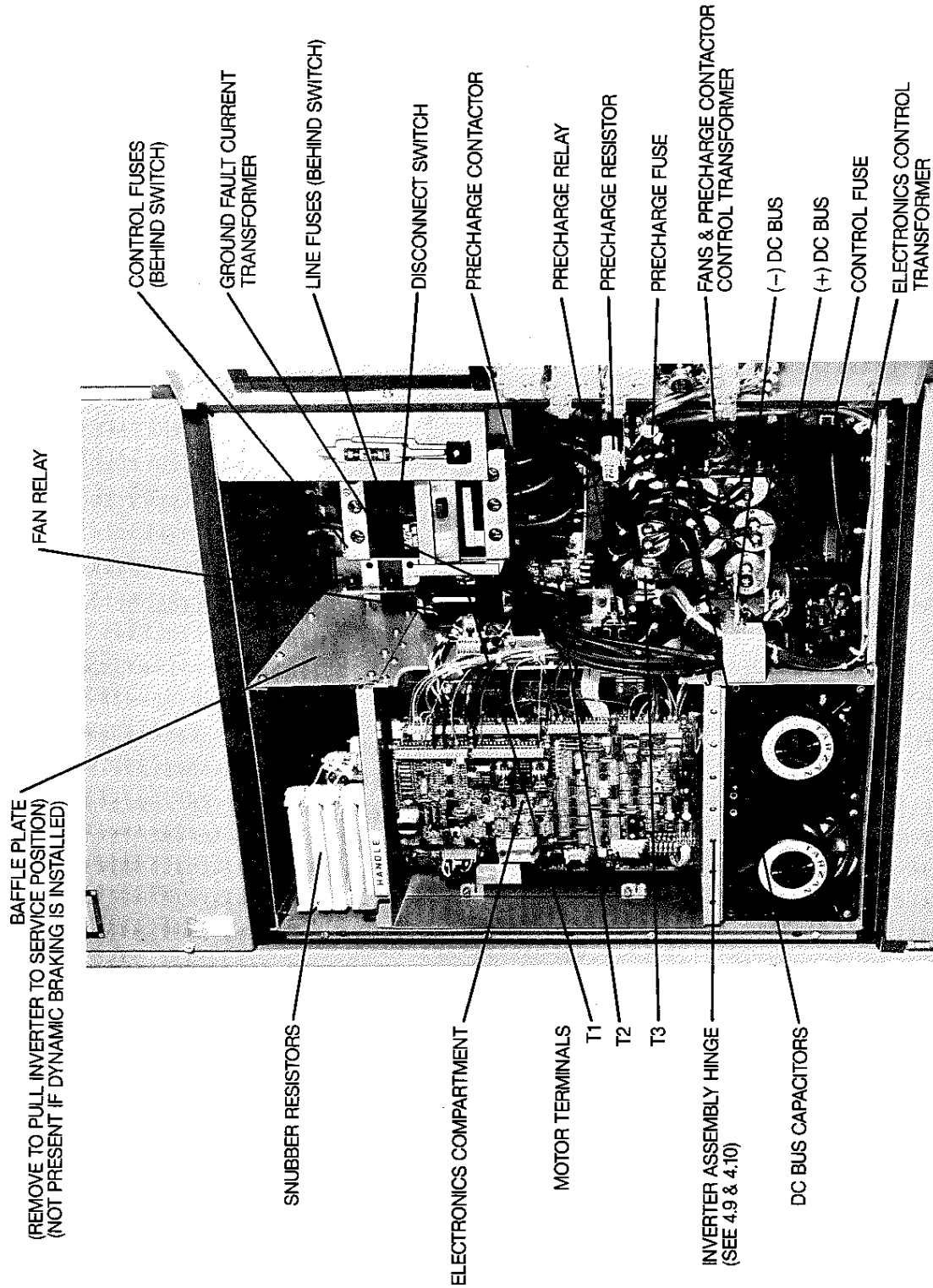

4.5 GROUND BUS ACCESS — HEATSINK FAN REMOVAL

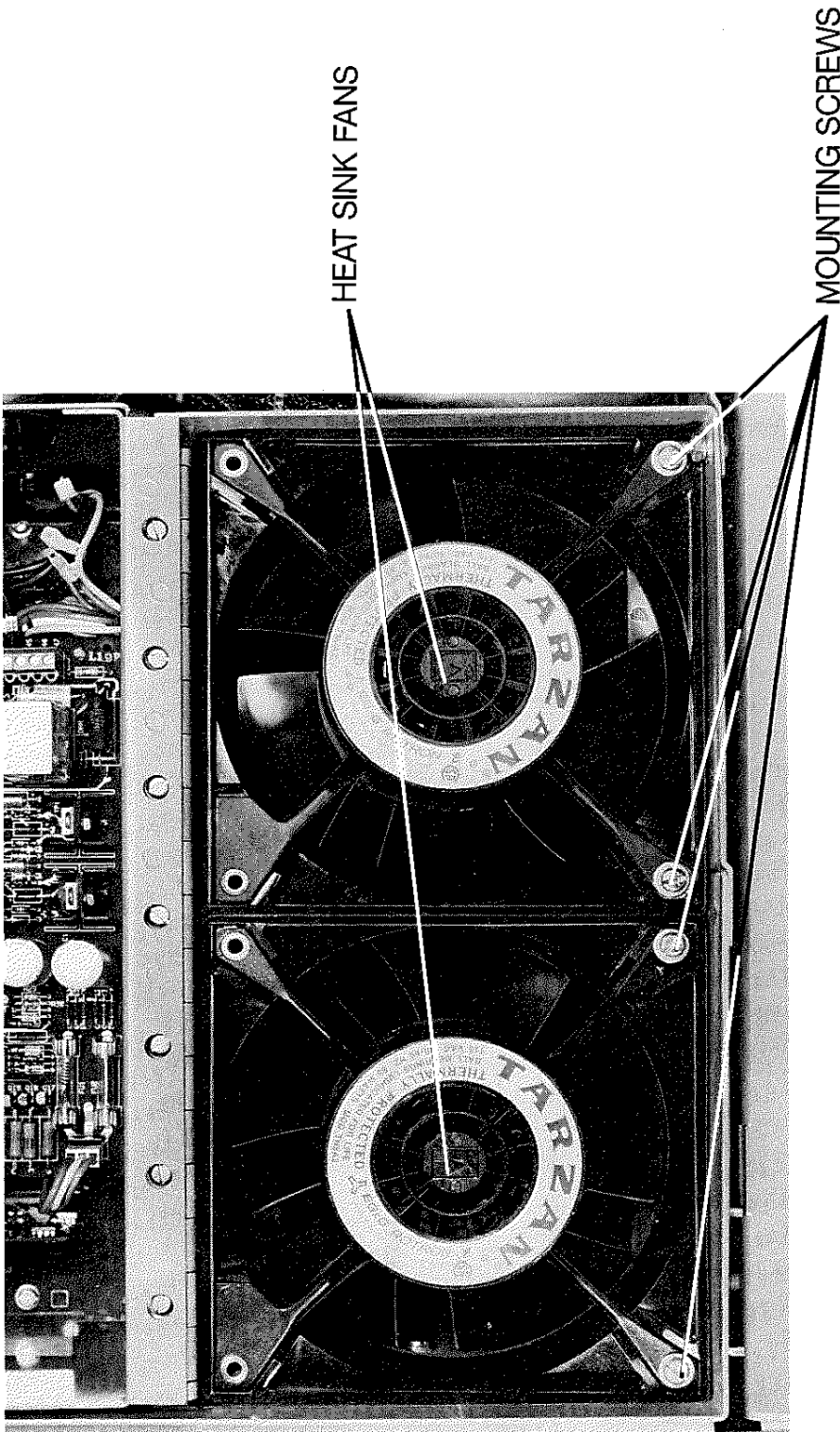

4.6 GROUND BUS ACCESS — FAN BRACKET REMOVAL

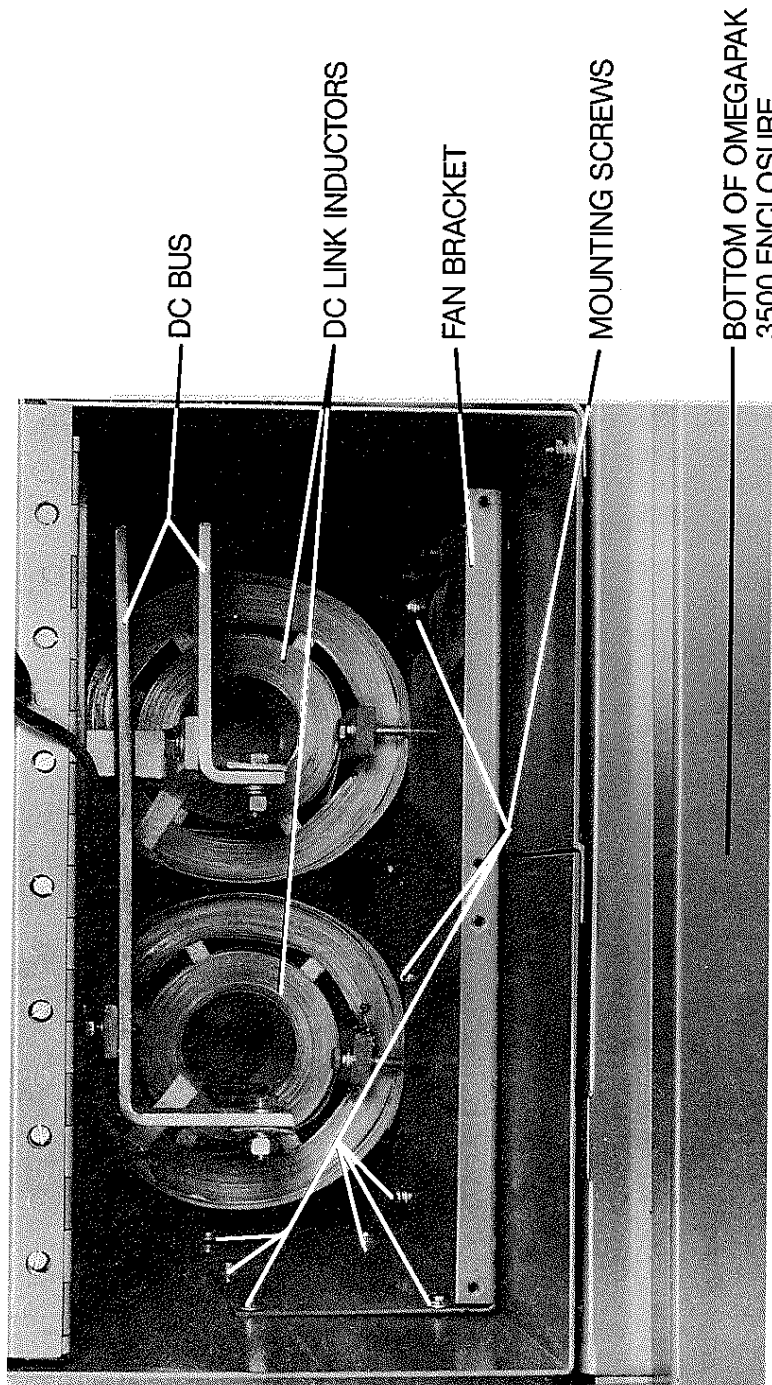

4.7 CLOSE-UP OF MAIN CONTROL AND OPTION BOARD

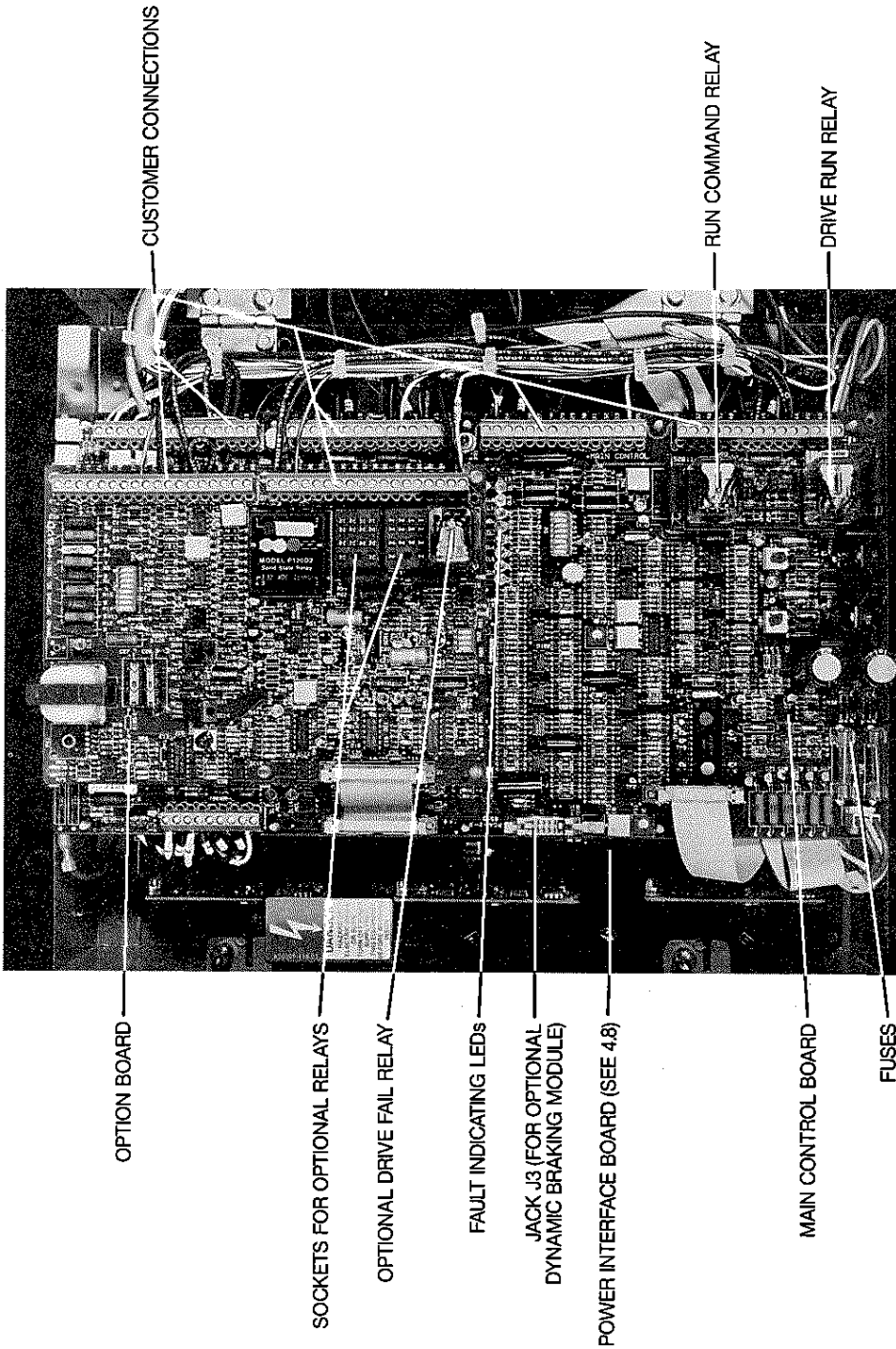

4.8 CLOSE-UP OF POWER INTERFACE BOARD

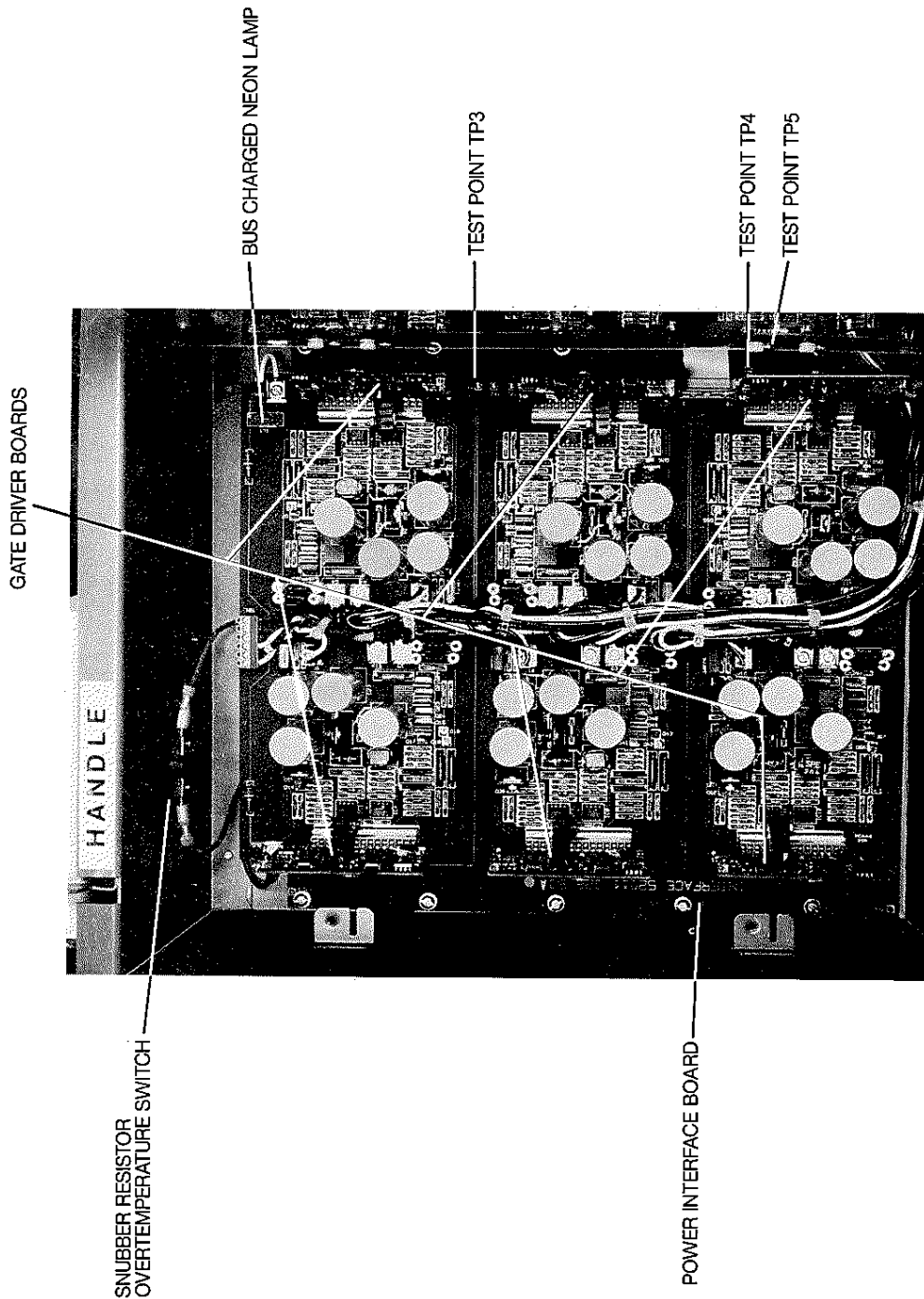

4.9 INVERTER IN SERVICE POSITION

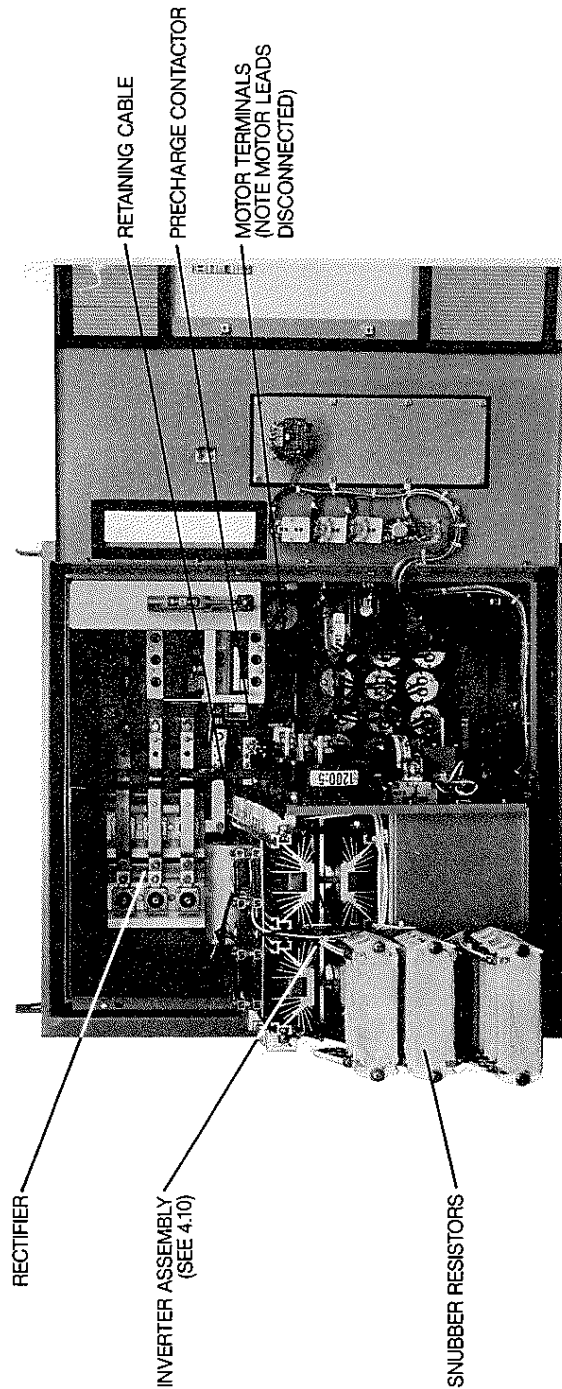

4.10 CLOSE-UP OF INVERTER ASSEMBLY

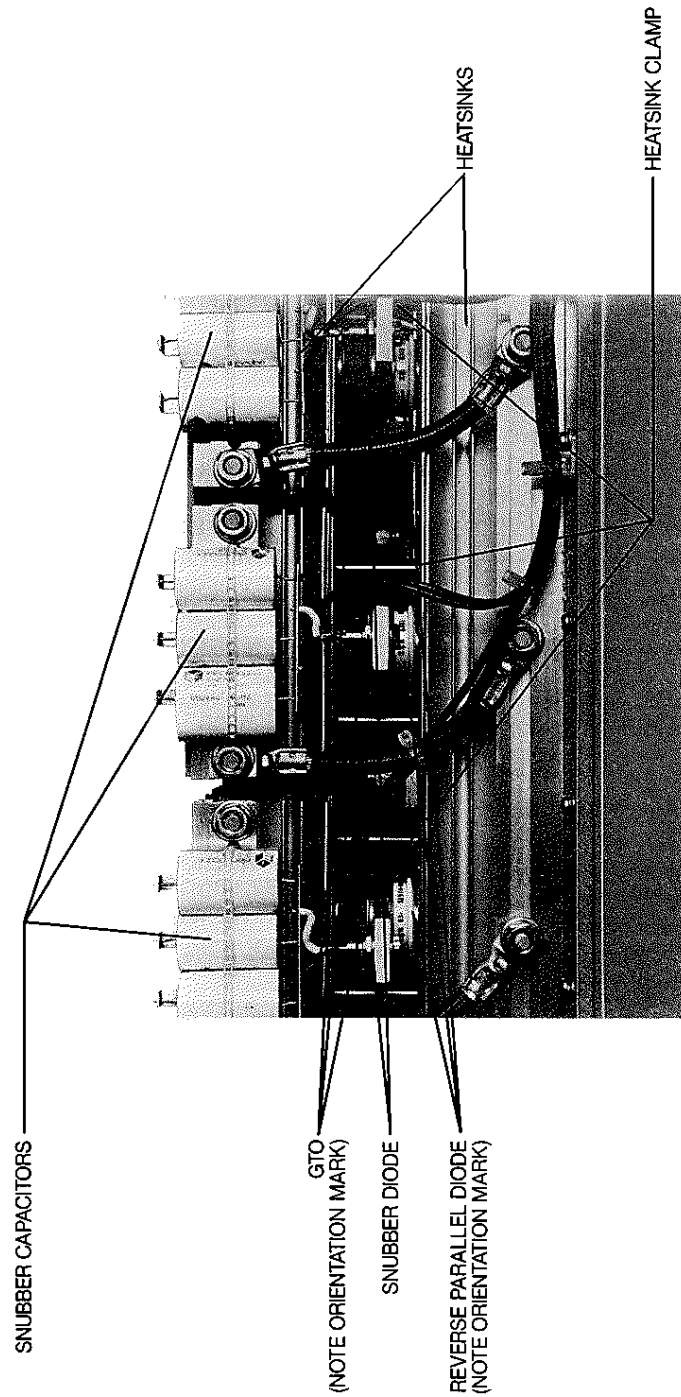

5.0 INITIAL START-UP PROCEDURE

5.1 INITIAL START-UP PROCEDURE WITHOUT OPTION BOARD

The OMEGAPAK controller has been tested at the factory and should require only minor adjustments to complete the field installation. This start-up procedure should be followed step by step. In case of difficulty refer to the TROUBLESHOOTING section of this service bulletin.

DANGER
HAZARD OF ELECTRICAL SHOCK OR BURN BEFORE SERVICING, TURN OFF POWER SUPPLY(S) TO THIS EQUIPMENT. WAIT FIVE MINUTES. MEASURE CAPACITOR VOLTAGES TO VERIFY THEY ARE ZERO. DO NOT SHORT ACROSS CAPACITORS WITH VOLTAGE PRESENT.

WITH ALL INCOMING POWER REMOVED, make the following equipment settings and adjustment:

- A. Verify that all equipment disconnect means are open.
- B. Connect the Control Power Transformer primary taps of both control power transformers as illustrated in Section 6.0, Figures 6.1 and 6.2, for the system input voltage. Refer to Section 4.0, OMEGAPAK Controller Photo for location of the control power transformers.
- C. Connect the Control Power Transformer primary taps for the Isolation Contactor or Isolation and By-Pass Contactor (if used) as illustrated in Section 6.0, Figure 6.2, for the system input voltage. Refer to Section 4.0, OMEGAPAK Controller Photo for location of the control power transformer.
- D. Connect the Dynamic Braking Resistors (if used) as illustrated in Section 11.0, Drawing 11.8.1, for the system input voltage.
- E. Set selection switches SW1 through SW8 on the main control board as required. See Section 6.0, Figure 6.3. Refer to Section 8.0, Selection Switch Placement chart, for location of switch.

F. Configure the snip-out resistors on the main control board as required. See Section 6.0, Figure 6.4. Refer to Section 8.0, Snip-Out Resistor Placement chart, for location of resistors.

G. The following adjustments on the main control board were factory set as follows. Refer to Section 8.0, Potentiometer Placement chart, for location of potentiometers. *Do not adjust any potentiometers unless directed in the start-up procedure.*

+10VDC SUPPLY ADJUST (P1)*	+10vdc
-10VDC SUPPLY ADJUST (P2)*	-10vdc
REGEN CURRENT LIMIT (P3)	Maximum (full clockwise)
MOTOR CURRENT LIMIT (P4)	Maximum (full clockwise)
OVERLOAD THRESHOLD (P5)	Maximum (full clockwise)
GAIN ADJUST (P6)*	Optimized for controller
FREQUENCY CLOCK OFFSET (P7)	Disabled
HAND MINIMUM SPEED (P8)	Minimum 1.25 Hz (full counterclockwise)
ACCELERATION TIME (P9)	Maximum (full clockwise)
DECELERATION TIME (P10)	Maximum (full clockwise)
SLIP COMPENSATION (P11)	Minimum (full counterclockwise)
VOLTS/HERTZ TRIM (P12)*	Optimized for standard motor
VOLTAGE BOOST (P13)	Minimum (full counterclockwise)
MAXIMUM SPEED (P14)	60 Hz Output with nominal speed ref.
OFFSET NULL (P15)*	Optimized for controller

* Designates potentiometers that have been factory sealed. **DO NOT ADJUST!**

- H. Place the Start switch (controller mounted or remote mounted) to the off position.
- I. Set the Manual Speed adjustment potentiometer (controller mounted or remote mounted) to minimum (full counterclockwise).
- J. Check wiring of input power panel ground, motor, manual speed potentiometer (if remote) and Start-Stop circuit connections, (if remote). Refer to Section 11.0 for the controller connection diagram and wiring diagram for remote control operators station.

- K. Verify that the incoming line voltage at the line side of the disconnecting means is within +10% to -5% of the controller nameplate input voltage.

DANGER
HAZARD OF ELECTRICAL SHOCK OR BURN
CONTROLLER PANEL MUST BE PROPERLY GROUNDED BEFORE APPLYING POWER. CLOSE AND SECURE ENCLOSURE DOOR BEFORE APPLYING POWER.

WITH INCOMING POWER PRESENT

DANGER
HAZARD OF ELECTRICAL SHOCK OR BURN
CERTAIN ADJUSTMENTS AND TEST PROCEDURES REQUIRE THAT POWER BE APPLIED TO THIS CONTROLLER. WHEN WORKING WITH ENERGIZED EQUIPMENT, EXTREME CAUTION MUST BE EXERCISED AS HAZARDOUS VOLTAGES EXIST. THE ENCLOSURE DOOR MUST BE CLOSED AND SECURED WHILE TURNING ON POWER, OR STARTING AND STOPPING THIS CONTROLLER.

- L. Close and secure the enclosure door. Close the equipment disconnect means. The Power On lamp (if used) should light. Other lamps (if used) may be tested by pushing their lenses (if push to test lamps are used).

- M. Open the electronics compartment door to verify that **only** LED's (IL1) and (IL2) on the Main Control Board, and Neon lamp (IL1) on the Power Interface Board are lighted. Refer to Section 8.0, LED Placement Chart for location of LED's and Section 4.0, Controller Photo, for location of Neon lamp.

- N. Initiate the Start circuit. Slowly turn the Manual Speed adjustment potentiometer clockwise to accelerate the drive motor. Check the direction of motor rotation. If correct, proceed to step Q. If incorrect, stop drive[Ⓢ]. **REMOVE ALL POWER!**

DANGER
HAZARD OF ELECTRICAL SHOCK OR BURN
BEFORE SERVICING, TURN OFF POWER SUPPLY(S) TO THIS EQUIPMENT. WAIT FIVE MINUTES. MEASURE CAPACITOR VOLTAGES TO VERIFY THAT THEY ARE ZERO. DO NOT SHORT ACROSS CAPACITORS WITH VOLTAGE PRESENT.

- O. Correct the direction of motor rotation by one of the following methods:
1. If a Forward-Reverse selector switch is not used, place a jumper from TB1-22 to TB1-27 on the main control board.
 2. If a Forward-Reverse selector switch is used, change the contact arrangement on the Forward-Reverse selector switch. Refer to Section 11.0, wiring diagrams, for controller mounted or remote mounted pilot devices.
- P. Reset the Manual Speed adjustment potentiometer setting to minimum speed (full counter clockwise). Close and secure the enclosure door then, reapply power and restart the controller.
- Q. Slowly increase the Manual Speed adjustment potentiometer setting to maximum (full clockwise). The motor speed should follow. If the motor will not accelerate refer to Section 6.0, Controller Adjustments, for setting of the Voltage Boost Potentiometer (P13).
- R. Check the maximum motor speed. Adjust the Max Speed Potentiometer (P14) on the main control board to obtain motor rated speed.
- S. Return the Manual Speed adjustment potentiometer to minimum setting (full counterclockwise). The motor speed[Ⓢ] should follow.
- T. Slowly adjust the Hand Minimum Speed Potentiometer (P8) on the main control board to obtain the desired minimum speed.
- U. Using the Manual Speed adjustment potentiometer adjust the motor speed for the point of maximum motor current. (This must not exceed the motor or controller nameplate current.) Slowly turn the Overload Threshold Adjust Potentiometer (P5) on the main control board counter-

clockwise until the Overload Timer LED (IL11) lights. Now, slowly turn P5 clockwise until the Overload Timer LED (IL11) just extinguishes. Then turn P5 an additional 5 degrees clockwise rotation.

NOTE: If the motor cannot be loaded refer to Section 6.0, Controller Adjustments, for alternate method of adjusting the Overload Threshold Adjust Potentiometer (P5).

CAUTION

THIS CONTROLLER DOES NOT PROVIDE OVERTEMPERATURE PROTECTION FOR THE MOTOR AT ALL SPEEDS OR LOADING CONDITIONS. A MOTOR THERMAL SENSOR IS RECOMMENDED.

V. The Acceleration Time (P9) and Deceleration Time (P10) potentiometers on the main control board may be adjusted to suit individual applications. If a high inertia load is present, then the drive may require extremely long times to decelerate if no dynamic braking or regenerative control options are used. If an overvoltage trip occurs during deceleration, increase the deceleration time setting.

W. This completes the initial start-up procedure. The controller is now setup for most applications.

The settings listed above are suitable for most applications. If your application requires different operating characteristics, refer to Section 6.0, Controller Adjustment, in this service bulletin.

Abnormal Operation

Refer to Section 7.0, Diagnostic Indicating Lights, if any of the following LEDs on the main control board are illuminated.

- IL3 Undervoltage (UV)
- IL4 Overvoltage (OV)
- IL5 Shoot Through (ST)
- IL6 Ground Fault (GF)
- IL7 Instantaneous Overcurrent (IOC)
- IL8 Overload (OLD)
- IL9 Overtemperature (OT)
- IL10 Option Fault (OF)
- IL11 Overload Timer (OLT)
- IL13 Drive Lockout (DL)

5.2 INITIAL START-UP PROCEDURE WITH OPTION BOARD

The OMEGAPAK controller has been tested at the factory and should require only minor adjustments to complete the field installation. This start-up procedure should be followed step by step. In case of difficulty refer to the TROUBLESHOOTING section of this service bulletin.

DANGER

HAZARD OF ELECTRICAL SHOCK OR BURN BEFORE SERVICING, TURN OFF POWER SUPPLY(S) TO THIS EQUIPMENT. WAIT FIVE MINUTES. MEASURE CAPACITOR VOLTAGES TO VERIFY THEY ARE ZERO. DO NOT SHORT ACROSS CAPACITORS WITH VOLTAGE PRESENT.

WITH ALL INCOMING POWER REMOVED, make the following equipment settings and adjustment:

- A. Verify that all equipment disconnect means are open.
- B. Connect the Control Power Transformer primary taps of both control power transformers as illustrated in Section 6.0, Figures 6.1 and 6.2, for the system input voltage. Refer to Section 4.0, OMEGAPAK Controller Photo, for location of the control power transformers.
- C. Connect the Control Power Transformer primary taps for the Isolation Contactor or Isolation and By-Pass Contactor (if used) as illustrated in Section 6.0, Figure 6.2, for the system input voltage. Refer to Section 4.0, OMEGAPAK Controller Photo, for location of the control power transformer.
- D. Connect the Dynamic Braking Resistors (if used) as illustrated in Section 11.0, drawing 11.8.1 for the system input voltage.
- E. Temporarily place a jumper from TB1-89 to TB1-91 on the option board. If TB1-89 and TB1-91 not present on option board, disregard this step.
- F. Determine the type of option board installed and if the shutdown reference (SPEED) mode of operation is used, then proceed as follows:

Non-Isolated or Isolated Option Board
(Mod. A07, B07, C07)

Temporarily disconnect and isolate the analog follower input signal wiring from TB1 of the option board. Proceed to Step G.

Pneumatic Option Board (Mod. D07)

Connect an automatic follower pneumatic signal to the pressure sensor PS1. Proceed to Step G.

Shutdown Reference (Speed) (if used)

The jumper between TB1-12 (+10vdc) on the main control board and TB1-80 (Jog Ref.) on the option board must be moved. Remove one end of the jumper from TB1-80 (Jog Ref.) and re-connect to TB1-82 (Shutdown Ref.) on the option board. Leave the other end of the jumper connected to TB1-12 (+10vdc) on the main control board.

G. Set selection switches SW1 through SW8 on the main control board as required. See Section 6.0, Figure 6.3. Refer to Section 8.0, Selection Switch Placement chart, for location of switch. Temporarily set SW4 to the open position. This will prevent nuisance shutdowns due to option fault when adjusting the MOD C07 isolated follower.

H. Configure the snip-out resistors on the main control board as required. See Section 6.0, Figure 6.4. Refer to Section 8.0, Snip-Out Resistor Placement chart, for location of resistors.

I. Set selection switches SW1-1 through SW1-4 or switches SW1-5 through SW1-8 on the option board (if used) as required. See Section 6.0, Figure 6.5. Refer to Section 8.0, Selection Switch Placement chart, for location of switch.

J. Set selection switches SW2-1 through SW2-4 on the option board for the Sequence Timing Relay (STR), time delay as required (if used). See Section 6.0, Figure 6.5. Refer to Section 8.0, Selection Switch Placement chart for location of switch. For controllers equipped with check valves, the incomplete sequence timing relay must be set for a time greater than that required for the check valve to operate.

K. The following adjustments on the main control board were factory set as follows. Refer to Section 8.0, Potentiometer Placement chart, for location of potentiometers. (Do not adjust any potentiometers unless directed in the start-up procedure).

+10VDC SUPPLY	+10vdc
ADJUST (P1)*	
-10VDC SUPPLY	-10vdc
ADJUST (P2)*	
REGEN CURRENT	Maximum (full
LIMIT (P3)	clockwise)
MOTOR CURRENT	Maximum (full
LIMIT (P4)	clockwise)
OVERLOAD	Maximum (full
THRESHOLD (P5)	clockwise)
GAIN ADJUST (P6)*	Optimized for controller
FREQUENCY CLOCK	Disabled
OFFSET (P7)	
HAND MINIMUM	Minimum 1.25 Hz (full
SPEED (P8)	counterclockwise)
ACCELERATION TIME	Maximum (full
(P9)	clockwise)
DECELERATION TIME	Maximum (full
(P10)	clockwise)
SLIP COMPENSATION	Minimum (full
(P11)	counterclockwise)
VOLTS/HERTZ TRIM	Optimized for standard
(P12)*	motor
VOLTAGE BOOST (P13)	Minimum (full
	counterclockwise)
MAXIMUM SPEED (P14)	60 Hz Output with
	nominal speed ref.
OFFSET NULL (P15)*	Optimized for controller

* Designates potentiometers that have been factory sealed. **DO NOT ADJUST!**

L. The following adjustments on the option board were factory set as follows. Refer to Section 8.0 Potentiometer Placement chart, for location of potentiometers. (Do not adjust any potentiometers unless directed in the start-up procedure).

ZERO (P3) (if used)*	Optimized for Option Board
MIN SP/OFFSET (P2)**	Zero output with 3 PSI input or zero offset.

* Designates potentiometers that have been factory sealed. **DO NOT ADJUST!**

** Factory sealed on Pneumatic Option Board (MOD D07) only.

Adjust the potentiometers on the option board as follows:

SPAN 1 (P1) (if used)	Minimum (full
	counterclockwise)
SPAN 2 (P4) (if used)	Minimum (full
	counterclockwise)
JOG/SHUTDOWN REF	Minimum (Full
(P5)	counterclockwise)

- M. Set the HAND-OFF-AUTO switch to OFF[Ⓢ].
- N. Set the MANUAL SPEED adjustment potentiometer to minimum (full counterclockwise)
- O. Confirm that the Isolation-Bypass Unit (if used) AFC-Off-Line selector switch is in the OFF position.
- P. Check wiring of input power, panel ground, motor, manual speed potentiometer (if remote) and Hand-Off-Auto circuit connections, (if remote). Refer to Section 11.0 for the controller connection diagram and wiring diagram for remote control station.
- Q. Verify that the incoming line voltage at the line side of the disconnecting means is within +10% to -5% of the controller nameplate input voltage.

DANGER
HAZARD OF ELECTRICAL SHOCK OR BURN
CONTROLLER PANEL MUST BE PROPERLY
GROUNDING BEFORE APPLYING POWER.
CLOSE AND SECURE ENCLOSURE DOOR
BEFORE APPLYING POWER.

WITH INCOMING POWER PRESENT

DANGER
HAZARD OF ELECTRICAL SHOCK OR BURN
CERTAIN ADJUSTMENTS AND TEST PRO-
CEDURES REQUIRE THAT POWER BE AP-
PLIED TO THIS CONTROLLER. WHEN WORK-
ING WITH ENERGIZED EQUIPMENT, EX-
TREME CAUTION MUST BE EXERCISED AS
HAZARDOUS VOLTAGES EXIST. THE
ENCLOSURE DOOR MUST BE CLOSED AND
SECURED WHILE TURNING ON POWER,
OR STARTING AND STOPPING THIS
CONTROLLER.

- R. Close and secure the enclosure door. Close the equipment disconnect means. The Power On lamp (if used) should light. Other lamps (if used) may be tested by pushing their lenses (if push to test lamps are used).
- S. Verify that **only** the following lamps are lighted: LED's (IL1) and (IL2) on the Main Control Board, IL2 (if used), IL3 (if used) and IL7 on the Option Board and Neon

Lamp (IL1) on the Power Interface Board. Refer to Section 8.0, LED Placement chart, for location of LED's and Section 4.0 Controller Photo, for location of Neon lamp.

NOTE: It is possible that LED (IL10) on the main control board may be lighted if an isolated follower (MOD C07) board is being adjusted.

- T. If an Isolation-Bypass unit is not used proceed to Step X.
- U. If the Isolation-Bypass unit is used, turn the AFC-Off-Line selector switch to the Line position. If necessary, adjust the disconnect means trip setting to the lowest value that will not result in nuisance tripping. The motor should accelerate to full speed. Check the motor rotation. If it is incorrect, stop the drive by turning the AFC-Off-Line selector switch to Off. **REMOVE ALL POWER!**
- V. Correct the phase sequence of the motor by reversing motor leads T1 and T2 at the output of the Isolation-Bypass unit. Reapply power.
- W. Turn the Isolation-Bypass unit (if used) AFC-Off-Line selector switch to AFC.
- X. Close and secure the enclosure door. Turn the Hand-Off-Auto[Ⓢ] Selector Switch to Hand. Slowly turn the Manual Speed adjustment potentiometer clockwise to accelerate the drive motor. Check the direction of motor rotation. If correct, proceed to Step AA. If incorrect, stop drive[Ⓢ]. **REMOVE ALL POWER!**

DANGER
HAZARD OF ELECTRICAL SHOCK OR BURN
BEFORE SERVICING, TURN OFF POWER
SUPPLY(S) TO THIS EQUIPMENT. WAIT FIVE
MINUTES. MEASURE CAPACITOR VOLTAGES
TO VERIFY THAT THEY ARE ZERO. DO NOT
SHORT ACROSS CAPACITORS WITH
VOLTAGE PRESENT.

- Y. Correct the direction of motor rotation by one of the following methods:
 1. If a Forward-Reverse selector switch is not used, place a jumper from TB1-22 to TB1-27 on the main control board. Proceed to Step AA.

2. If a Forward-Reverse selector switch is used, change the contact arrangement on the Forward-Reverse selector switch. Refer to Section 11.0, wiring diagrams for controller mounted or remote pilot devices.
- Z. Reset the Manual Speed adjustment potentiometer setting to minimum speed (full counterclockwise). Close and secure the enclosure door then, reapply power and restart the controller.
- AA. Slowly increase the Manual Speed adjustment potentiometer setting to maximum (full clockwise). The motor speed should follow. If the motor will not accelerate refer to Section 6.0, Controller Adjustment, for setting of the Voltage Boost Potentiometer (P13).
- BB. Check the maximum motor speed. Adjust the Maximum Speed Potentiometer (P14) on the main control board to obtain motor rated speed.
- CC. Return the Manual Speed adjustment potentiometer to minimum setting (full counterclockwise). The motor speed① should follow.
- DD. Slowly adjust the Hand Minimum Speed potentiometer (P8) on the main control board to obtain the desired minimum speed.
- EE. Using the Manual Speed adjustment potentiometer adjust the motor speed for the point of maximum motor current. (This must not exceed the motor or controller nameplate current.) Slowly turn the Overload Threshold Adjust Potentiometer (P5) on the main control board counterclockwise until the Overload Timer LED (IL11) lights. Now, slowly turn P5 clockwise until the Overload Timer LED (IL11) just extinguishes. Then turn P5 an additional 5 degrees clockwise rotation.

NOTE: If the motor can not be loaded refer to Section 6.0, Controller Adjustment, for alternate method of adjusting the Overload Threshold Adjust Potentiometer (P5).

- FF. The Acceleration Time (P9) and Deceleration Time (P10) Potentiometers on the main control board may be adjusted to suit individual applications. If a high inertia load is present, then the drive may require extremely long times to decelerate if no dynamic braking or regenerative control options are used. If an overvoltage trip occurs during deceleration, increase the deceleration time setting.
- GG. Turn the Hand-Off-Auto③ switch to Auto. Proceed to the section which corresponds to the type of option board installed.

CAUTION

THIS CONTROLLER DOES NOT PROVIDE OVERTEMPERATURE PROTECTION FOR THE MOTOR AT ALL SPEEDS OR LOADING CONDITIONS. A MOTOR THERMAL SENSOR IS RECOMMENDED.

- GGA. **Pneumatic Option Board Mod. D07** (Kit Class 8804, type MC-11)
Apply a 0% automatic follower pneumatic (3 PSIG) signal to the pressure sensor (PS1). The drive should accelerate to minimum speed. Increase the signal to 15 PSIG. The motor speed should increase to rated speed. Proceed to Step HH.
- GGB. **Isolated Option Board Mod. C07** (Kit Class 8804, type MC-12)
Refer to the two paragraphs below for the type of analog follower input signal used.

“Zero-Based Signal” (Zero Offset)

A Zero-based signal is an analog follower input signal that does not use an offset level. A 0-10V signal is one form of a zero-based signal.

Apply 0% of the zero-based follower input signal to TB1-75 (+) and TB1-74 (-) (dc current input) or TB1-71 (+) and TB1-74 (-) (dc voltage input) or TB1-73 and TB1-72 (ac voltage input). The drive should accelerate to intermediate speed. Adjust P2 (MIN SP/OFFSET) on the option board for the desired minimum motor speed. Increase the analog follower input signal to 100% of the

zero-based signal. The drive should accelerate to intermediate speed. Adjust P1 (SPAN 1) on the option board for the rated motor speed. Proceed to Step HH.

“Live Zero” (Offset) Signal (Above Zero Offset)

A live-zero signal is an analog follower input signal that uses an offset level. A 4-20 MA signal is one form of a live-zero signal.

For adjustment purposes, an equivalent zero-based signal must be used. To create this signal, subtract the offset from the “Live Zero” signal (i.e. a 4-20 MA signal will be converted to a 0-16 MA signal). Use the proper equivalent zero based signal in the following procedure:

Apply 0% of the equivalent zero-based analog follower input signal to TB1-75 (+) and TB1-74 (dc current input) or TB1-71 (+) and TB1-74 (-) (dc voltage input) or TB1-73 and TB1-72 (ac voltage input). The drive should accelerate to intermediate speed. Adjust P2 (MIN SP/OFFSET) on the option board to obtain absolute minimum motor speed. Increase the analog follower input signal to 100% of the equivalent zero-based signal. The drive should accelerate to intermediate speed. Adjust P1 (SPAN 1) on the option board for the rated motor speed. At this point, a “Live Zero” signal is necessary to complete the adjustment. Decrease the analog follower input signal to the live-zero offset level. Readjust P2 (MIN SP/OFFSET) to obtain the desired minimum speed. Proceed to Step HH.

GGC. Non-Isolated Option Board (with or without Run Relay) (Mod A07, B07) (Kit Class 8804, Type MC-11) or (Kit Class 8804, Type MC-14)

The non-isolated option board can be used with a potentiometer input, voltage input, or current input. If the input signal is isolated from ground, minimum speed/offset adjustments and span adjustments may be made.

The set-up procedure for two of the most common input strategies is described below. For input signals not described below, refer to Section 6.2.3. for set-up adjustment.

“Zero Based” Signal (Zero Offset)

A zero-based signal is an analog input that does not use an offset level. A 0-10 volt signal from a potentiometer is one form of a zero based signal. Zero volts input may be adjusted for absolute minimum speed or a minimum speed greater than absolute.

With the controller deenergized, connect a 5 K ohm potentiometer as shown in Figure 5.1 and remove snip out resistor R92 from the option board. Energize the controller. Turn P2 (Min SP/OFFSET) full CW. Turn the input potentiometer full CW and adjust P4 (SPAN 2) for base (60 Hz) speed. Turn input potentiometer full CCW and adjust P2 (MIN SP/OFFSET) CCW until the desired minimum speed is obtained.

“Live Zero” (Offset) Signal (Above Zero Offset)

A live zero signal is an analog input signal that uses an offset level. For example, a 2 to 10 V voltage supply could be used to control the output from absolute minimum speed to base speed. For this application, the supply must be connected as shown in Figure 5.2.

Turn P2 (MIN SP/OFFSET) full CW. Apply 0% of live zero reference as measured from TB1-71 to test point TP4 on the option board (refer to Section 8, Figure 8.2 to determine the location of TP4). Adjust P2 (MIN SP/OFFSET) CCW until zero volts is measured from TB1-71 to TP4. Apply 100% of live zero reference as measured from TB1-71 to TB1-74 and adjust P4 (SPAN 2) for base (60 Hz) speed.

HH. Turn the Hand-Off-Auto[®] selector switch to Off. If check valve limit switches (pumping applications only) are used, the drive will continue to run when the Hand-Off-Auto[®] switch is switched Off until the check valve closes or until

FIGURE 5.1

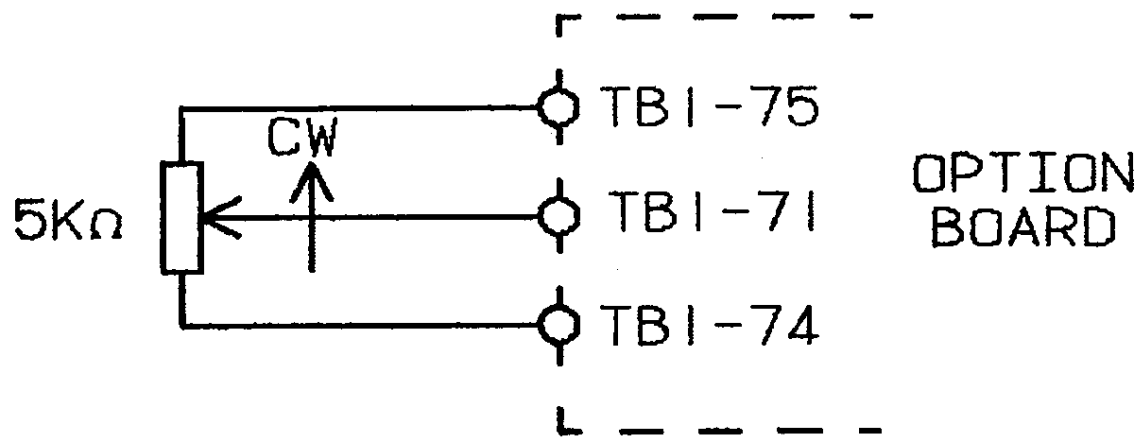
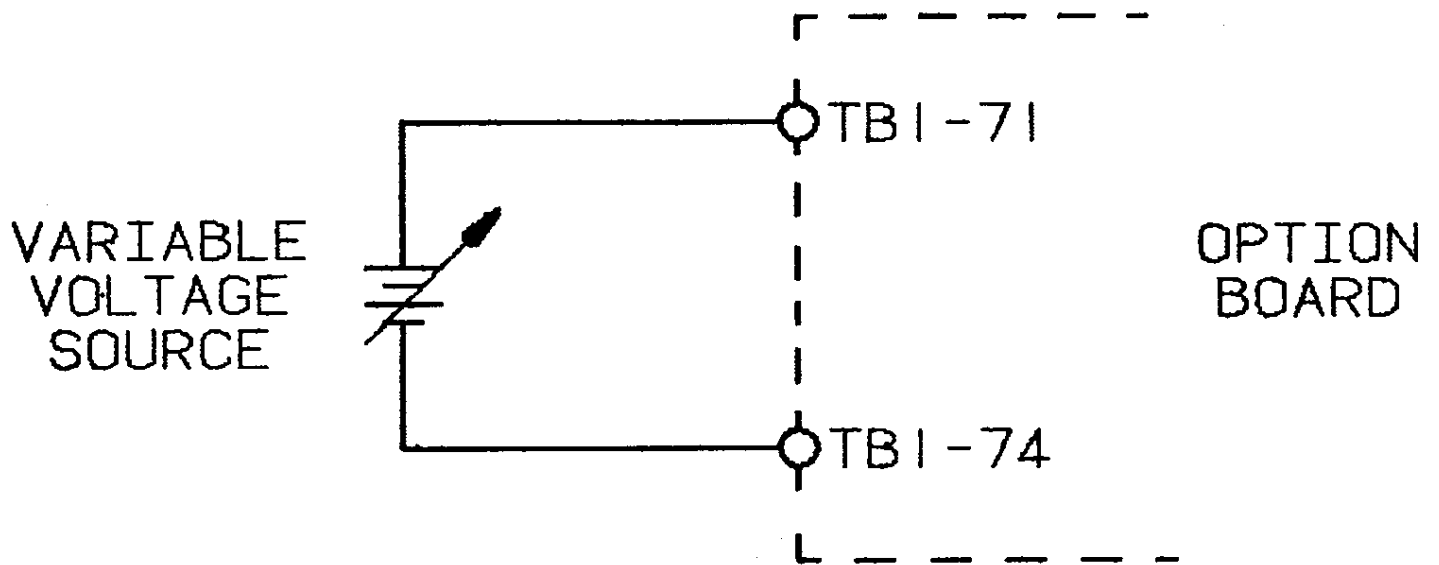

FIGURE 5.2



the Incomplete Sequence Timer times out (if used). The drive speed during this time is controlled by P5 (JOG/SHUT-DOWN REF.) on the option board. Adjust P5 (JOG/SHUTDOWN REF.) to obtain the desired shutdown speed.

- II. Return SW4 to the closed position. If annunciation only of option faults is desired, SW4 can be left in the open position. Refer to Section 6, Figure 6.3 for a description of main control board switch functions.
- JJ. Turn the Jog/Run selector switch (if used) to Jog. Depress the Start push button to run the drive. The drive speed at this time is controlled by the option board. Adjust P5 (JOG/SHUTDOWN REF.) to obtain the desired Jog speed. After the drive has stopped, **REMOVE ALL POWER!**

DANGER
HAZARD OF ELECTRICAL SHOCK OR BURN BEFORE SERVICING, TURN OFF POWER SUPPLY(S) TO THIS EQUIPMENT. WAIT 5 MINUTES. MEASURE CAPACITOR VOLTAGES TO VERIFY THAT THEY ARE ZERO. DO NOT SHORT ACROSS CAPACITORS WITH VOLTAGE PRESENT.

Remove all the jumpers installed in Step E. Reconnect any wires removed in Step F. Confirm that all wiring is per the option board used. Refer to Section 11.0, Option Board Wiring Diagrams.

KK. This completes the initial start-up and adjustment procedure. The controller is now set for most applications. If your application requires different operational characteristics, refer to Section 6.0, Controller Adjustment Description, in this service bulletin.

Abnormal Operation

Refer to Section 7.0, Diagnostic Indicating Lights, if any of the following LED's on the Main Control Board or Option Board are illuminated.

- A. Undervoltage (UV)
- B. Overvoltage (OV)
- C. Shoot Through (ST)
- D. Ground Fault (GF)
- E. Instantaneous overcurrent (IOC)
- F. Overload (OLD)
- G. Overtemperature (OT)
- H. Option Fault (OF)
- I. Overload Timer (OLT)
- J. Drive Lockout (DL)

- ① The drive may require as long as 60 seconds to decelerate or stop. If a high inertia load is present, then the drive may require extremely long times to decelerate unless the Dynamic Braking or Regeneration Unit options are installed.
- ② If pump check valve limit switches are used the drive will continue to run, until the check valve closes, when the Hand-Off-Auto^③ selector switch is turned to Off.
- ③ The Hand-Off-Auto selector switch may not always be used. Refer to Section 11.0, for other control configurations, either controller mounted or remote mounted.

6.0 CONTROLLER ADJUSTMENTS

A number of adjustments have been provided in the OMEGAPAK controller for modifying the controller operating characteristics. These adjustments include Printed Wiring Board mounted Selection Switches, Snip-Out Resistors and Potentiometers. If the controller contains optional equipment there may be adjustments associated with these too. Each adjustment is described in the following paragraphs.

CAUTION

DO NOT CHANGE THE POSITION OF ANY PRINTED WIRING BOARD SWITCH OR REMOVE ANY PRINTED WIRING BOARD WITH THE DRIVE RUNNING. TO DO SO MAY CAUSE AN EQUIPMENT MALFUNCTION.

- Set the selection switches SW1, SW2, SW3, SW6, SW7, and SW8 on the main control board for the desired system input voltage, motor voltage, and motor base frequency as illustrated in Figure 6.3. Additional system configurations are available as shown in Figure 6.7. (Refer to Section 8.0, selection switch placement chart, main control board, for selection switch location).

FIGURE 6.1 (A)

CONTROL TRANSFORMER CONNECTION ELECTRONICS CONTROL POWER (T1)		
SYSTEM INPUT VOLTAGE	PRIMARY TAPS	JUMPER CONNECTIONS
200	H1, H5	H1 TO H4, H2 TO H5
230	H1, H6	H1 TO H4, H3 TO H6
460	H1, H6	H3 TO H4

6.1 MAIN CONTROL BOARD ADJUSTMENTS

The adjustments on the main control board are:

- INPUT VOLTAGE SELECTION
- INPUT FREQUENCY SELECTION
- CONTROLLER FAULT LOCKOUT SELECTION
- ACCEL/DECEL TIME RANGE SELECTION
- MAX. OUTPUT FREQUENCY SELECTION
- POTENTIOMETER ADJUSTMENTS

6.1.1 INPUT VOLTAGE SELECTION

The controller is factory set to operate from 460vac. To operate the OMEGAPAK controller from 200vac or 230vac, the control power transformers jumper connections and selection switches must be repositioned. If optional isolation or isolation and by-pass contactor or dynamic braking unit is used, there are wiring jumper changes necessary to operate from 200vac or 230vac. The procedure is as follows:

- Reconnect the control power transformers jumper connections for the desired system input voltage as illustrated in Figures 6.1 and 6.2. (Refer to Section 4.0, Controller Photo, for control power transformer locations).

FIGURE 6.1 (B)

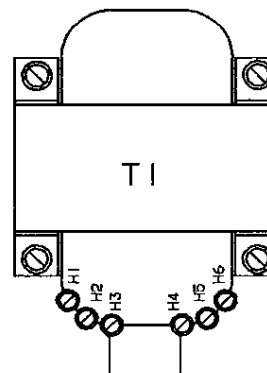

TERMINAL & JUMPER LOCATIONS
460V OPERATION

FIGURE 6.1 (C)

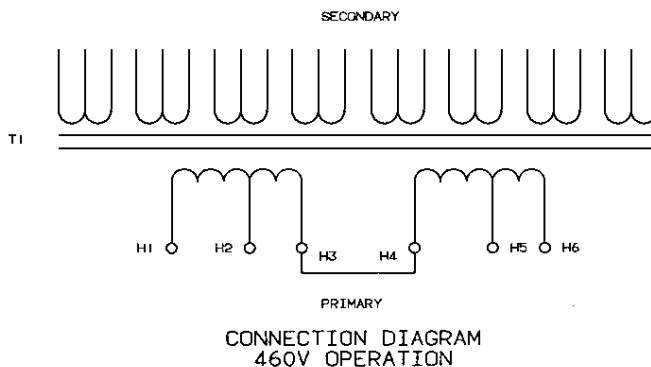

CONNECTION DIAGRAM
460V OPERATION

FIGURE 6.2 (A)

CONTROL TRANSFORMER CONNECTION FANS AND PRECHARGE CONTACTOR CONTROL POWER (T2)			
SYSTEM INPUT VOLTAGE	PRIMARY TAPS	SECONDARY TAPS	JUMPER CONNECTIONS
200	H1, H4	X1, X3	H1 TO H3, H2 TO H4
230	H1, H4	X1, X2	H1 TO H3, H2 TO H4
460	H1, H4	X1, X2	H2 TO H3

FIGURE 6.2 (B)

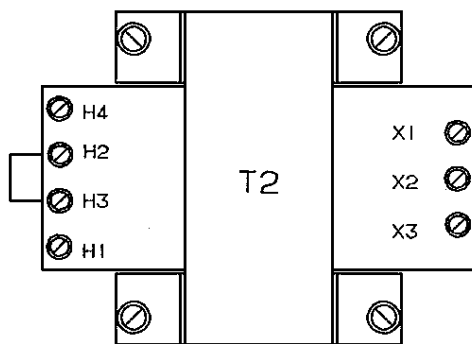

TERMINAL AND JUMPER LOCATIONS
460V OPERATION

FIGURE 6.2 (C)

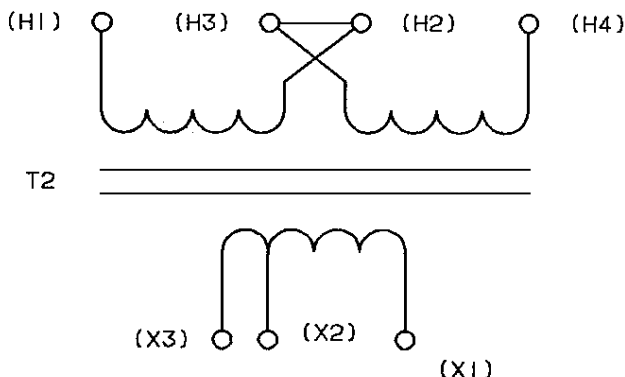

CONNECTION DIAGRAM
460V OPERATION

3. If optional isolation or isolation and bypass contactors are used with the OMEGAPAK 3500 controllers, their control power transformer jumper connections must be reconnected to operate from 200vac or 230vac as illustrated in Figure 6.2. (Refer to Section 4.0, OMEGAPAK Controller Photo, for control power transformer location.)

4. If optional dynamic braking unit is used with the OMEGAPAK controller, the dynamic braking resistors must be reconnected to operate from 200vac or 230vac. (Refer to Section 11.0, drawing 11.8.1, for resistor connections.)

6.1.2 INPUT FREQUENCY SELECTION

The controller is factory set to operate from 60 Hertz power. To operate the controller from 50 Hertz power, four (4) Main Control Board Snip-Out Resistors (R28, R25, R152, R15) must be removed as illustrated in Figure 6.4. (Refer to Section 8.0, Snip-Out Resistor Placement chart, Main Control Board, for snip-out resistors location.)

6.1.3 CONTROLLER FAULT LOCKOUT SELECTION

The controller is factory set to Lockout, requiring manual reset, on the first fault detected. Controller faults that will cause lockout are:

- Overvoltage (OV)
- Shoot Through (ST)
- Ground Fault (GF)
- Overload (OLD)
- Instantaneous Overcurrent (IOC)
- Overtemperature (OT)
- Option Fault (OF)

If first fault lockout is not desired, the controller can be set up for second fault lockout. When the controller is set up for second fault lockout operation, the drive will stop for 5 seconds, or the duration of the fault (whichever is longer), upon the first fault then restart automatically if two-wire control is used. If a second fault occurs within 65 seconds after the first fault the drive will stop and lockout.

To adjust the controller for two fault operation, one (1) Main Control Board Snip-Out Resistor (R172) must be removed as illustrated in Figure 6.4. (Refer to Section 8.0, Snip-Out Resistor Placement chart, Main Control Board, for snip-out resistor location).

NOTE: All controller faults can be manually reset by depressing the Reset Button (PB1) on the main control board (see component placement chart for PB1 location) or by interrupting power to the controller input.

An undervoltage (UV) trip condition will stop the drive but will not cause a controller lockout. After the undervoltage (UV) fault subsides the drive will immediately restart on two wire control systems. Systems with three wire control will require a manual restart.

6.1.4 ACCEL/DECCEL TIME RANGE SELECTION

The controller is factory set for an Accel/Decel Time Range Selection of 1 to 10 seconds. If longer accel/decel times are desired, the controller must be adjusted.

To adjust the controller for 10 to 60 seconds accel/decel time range, one (1) Main Control Board Selection Switch (SW5) must be set as illustrated in Figure 6.3. (Refer to Section 8.0, Selection Switch Placement chart, Main Control Board, for selection switch location).

NOTE: After the Accel/Decel Time Range has been selected, individual acceleration and deceleration times are adjustable by potentiometers. (Refer to Section 6.1.6, Potentiometer Adjustments).

6.1.5 MAXIMUM OUTPUT FREQUENCY SELECTION

The controller is factory set for 60 Hertz maximum output frequency. If higher output frequencies are desired, the controller must be adjusted.

CAUTION

SOME MOTORS AND/OR LOADS MAY NOT BE SUITED FOR OPERATION AT HIGHER THAN NAMEPLATE MOTOR SPEED AND FREQUENCY. TO AVOID DANGER OF OVERSPEED, CONSULT THE MOTOR MANUFACTURER AND EQUIPMENT MANUFACTURER BEFORE OPERATING THE MOTOR ABOVE 60 HERTZ.

After determining that the motor and its load are suitable for operation with an output frequency greater than 60 Hertz, the maximum output frequency range can be selected.

To adjust the controller for 90 Hertz or 120 Hertz maximum output frequency, certain main control board snip-out resistors must be removed. For 90 Hertz maximum output frequency, Snip-Out Resistor (R251) must be removed as illustrated in Figure 6.4 and the Maximum Speed (MSD) potentiometer must be adjusted as described in Section 6.1.6. For 120 Hertz maximum output frequency, Snip-Out Resistors (R250 and R251) must be removed as illustrated in Figure 6.4 and the Maximum Speed (MSD) potentiometer must be adjusted as described in Section 6.1.6. (Refer to Section 8.0, Snip-Out Resistor Placement chart, Main Control Board, for snip-out resistor location).

When the maximum output frequency has been selected, the connected motor will have the capability of driving a constant torque load to 60 Hertz and a load where the torque decreases as a function of the $(V/Hz)^2$ from 60 Hertz to 90 Hertz or 120 Hertz.

Some applications may require constant torque output of the motor to 90 Hertz or 120 Hertz. For these applications the controller input voltage must be 460V ac, with a motor connected for 230V ac. The controller output must be rated for the 230V ac connected motor nameplate rated current.

To adjust the controller for constant torque applications operating above 60 Hertz output frequencies, one (1) Main Control Board Selection Switch (SW2) must be repositioned as illustrated in Figure 6.3. (Refer to Section 8.0, Selection Switch Placement chart, Main Control Board, for selection switch location).

FIGURE 6.3
MAIN CONTROL BOARD DIP SWITCH SETTINGS

Switch	Function							
SW5	Accel/Decel Range Select							
	1-10 Sec. (Adjustable) X*				10-60 Sec. (Adjustable) O			
SW1 SW3 SW6 SW7	Controller Input/Motor Nameplate (Base) Voltage Select							
	Input (V)	200	230	230	460	460	460	460 ^②
	Base (V)	200	200	230	200	230	400	460 ^②
		X	X	X	X	X	O	O*
		X	X	O	X	O	O	O*
	O	O	O	X	X	X	X*	
	O	O	O	O	O	X	O*	
SW2	Volts Per Hertz Characteristic							
	Base Voltage At Base Freq.				Base Voltage At 2X Base Freq.			
	X*				O			
SW8	Nameplate (Base) Frequency Select ^②							
	60 Hertz X*				50 Hertz O			
SW4	Drive Stop On Option Fault							
	Dynamic braking unit, regen unit and/or option card failure will annunciate and stop drive upon fault.				Dynamic braking unit, regen unit and/or option card failure will only annunciate fault.			
	X*				O			

① This switch setting also applies to 380 volts input and a 380 V motor. It is necessary to select 50 Hertz operation on SW8 to get the correct volts/Hertz relationship and adjust potentiometer P14, maximum speed (MSD) per section 6.1.6 to achieve a base frequency of 50 Hertz.

② Operation from a 50 Hertz supply also requires removal of snip-out resistors per section 6, Figure 6.4.

Typical Printed Wiring Board Switch

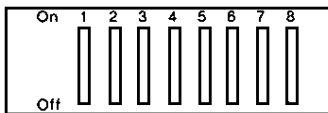

Depress this end to close (ON) switch

Depress this end to open (OFF) switch

X = Closed Switch (ON)
O = Open Switch (OFF)
* = Factory Setting

FIGURE 6.4
MAIN CONTROL BOARD SNIP-OUT RESISTORS

Snip-Out Resistors	Function	Condition
R28 R25 R152 R15	50 Hz or 60 Hz operation ^①	Installed: 60 Hz operation Removed: 50 Hz operation
R172	One or two fault lockout — all faults except UV and Regen.	Installed: Drive will lockout upon one fault. Removed: Drive will stop for 5 sec. upon 1st fault and will lockout upon 2nd fault occurring 65 sec. after 1st fault.
R251 R250	Normalizing maximum speed	Installed: With both resistors installed maximum output frequency is 60 Hz. Removed: R251-90 Hz maximum R251 and R250-120 Hz maximum.
R299	FCT linearity adjust	Installed: P7 (OFC) has no effect on circuit. Removed: P7 (OFC) may be adjusted to cancel offset in FCT reference.
R373	Power-up delay	Installed: 1.5 sec. delay. Removed: 6.5 sec. delay.
R420	Drive Restart after regen unit failure	Installed: Drive will restart immediately after fault subsides. Removed: Drive will restart 5 sec. after fault is initiated or immediately after fault subsides (whichever is longer).
R169	Hand reference input	Installed: Single ended input with minimum potentiometer. Note: R317 must not be present. Removed: Differential input. Note: R317 must be installed.

① Switch SW8 on the the main control board must also be positioned per Figure 6.3 if a 50 Hertz base frequency is also desired.

6.1.6 POTENTIOMETER ADJUSTMENTS

The potentiometer adjustments were factory set as described in the initial start-up procedure. Certain potentiometers are not expected to ever require adjustment. These have been factory sealed.

If further adjustments are necessary, adjust potentiometers one at a time in the following order.

P14- Maximum Speed (MSD) — This potentiometer is used to control the controller output frequency when the Manual Speed potentiometer (controller mounted or remote mounted) is set at its maximum level (full clockwise). This potentiometer is factory set so that the output frequency will be 60 Hertz when the Manual Speed potentiometer is set full clockwise. The Maximum Speed (MSD) potentiometer has an adjustment range of 40 Hertz to the selected maximum output frequency.

The maximum controller output frequency is selectable between 40 to 60 Hertz, 90 Hertz or 120 Hertz. (40-50 Hertz, 75 Hertz or 100 Hertz if a 50 Hz base frequency is selected per Section 6 Figures 6.3 and 6.4.) Refer to Section 6.1.5, Maximum Output Frequency Selection, in this service bulletin.

The Maximum Speed (MSD) potentiometer must be adjusted if a maximum frequency other than 60 Hertz is required. Clockwise rotation increases output frequency.

CAUTION

SOME MOTORS AND/OR LOADS MAY NOT BE SUITED FOR OPERATION AT HIGHER THAN NAMEPLATE MOTOR SPEED AND FREQUENCY. TO AVOID DANGER OF OVERSPEED, CONSULT THE MOTOR MANUFACTURER AND EQUIPMENT MANUFACTURER BEFORE OPERATING THE MOTOR ABOVE 60 HERTZ.

P7- Frequency Clock Offset(OFC) — This potentiometer is used to improve the linearity of output frequency vs input speed reference. For most applications, improved linearity is not required; however, should greater

linearity be required, the OFC potentiometer and the MSD potentiometer may be used to trim offset and gain errors in the voltage to frequency conversion.

ADJUSTMENT PROCEDURE

A. Snip-out resistor R299 must be removed before the OFC potentiometer has any effect on circuit operation. Place the OFC potentiometer at midscale.

B. Determine the voltage to frequency conversion required. For example, a 10 V input that would produce 60 Hz on the motor would be a voltage/frequency ratio of 1/6.

C. Remove the T1, T2, and T3 motor leads from the controller.

D. Connect a frequency counter from TP7 to TP12. (Note: TP designates test point. Refer to Section 8, Figure 1 for the location of test points.) This is a 0 to 10 V signal with a 1 to 2 microsec logic low pulse occurring 3360 times a cycle of motor frequency. Connect a voltmeter (0 to 20 VDC) from TB1-2 to TP12.

E. Energize the controller. Turn the manual speed potentiometer full CW. Adjust the maximum speed (MSD) potentiometer until the frequency measured at TP7 equals f_1 as calculated below.

$$f_1 = -3360 \times \frac{\text{(voltage at TB1-2 to TP12)}}{\text{(voltage to frequency ratio)}}$$

F. Turn the manual speed potentiometer CCW until the voltage, measured from TB1-2 to TP12 equals V_2 as calculated below.

$$V_2 = -3.5 \times \text{(voltage to frequency ratio)}$$

G. Adjust the OFC potentiometer until a frequency of 11.76 KHZ is measured.

H. Repeat step E if necessary.

P11-Slip Compensation (SC) — This adjustment potentiometer is used to improve motor speed regulation. Adjustment range covers 0 to 3% of max-

imum controller output frequency. The Slip Compensation (SC) potentiometer can be adjusted to provide speed regulation up to $\pm 0.5\%$ of base speed of a standard NEMA design B squirrel cage motor for operation from 1.25 to 60 Hertz.

This potentiometer is factory set for zero (0) slip compensation. If improved speed regulation is not required, this potentiometer should not be adjusted.

If improved speed regulation is required, this potentiometer must be adjusted. The adjustment procedure must be followed:

ADJUSTMENT PROCEDURE

A. Energize the controller with no load on the motor and adjust the Manual Speed potentiometer (controller mounted or remote mounted) to the motor base (60 Hertz) maximum speed position. Measure the actual motor shaft speed and record the value.

Note: For controllers adjusted for extended constant torque operation (refer to Section 6.1.5, Maximum Output Frequency Selection), adjust the Manual Speed potentiometer to the maximum speed position.

B. Load the motor.

C. Measure the motor shaft speed with the load applied and adjust the Slip Compensation (SC) potentiometer so that the speed matches the value recorded in Step A.

If the Slip Compensation (SC) potentiometer is not adjusted correctly, the motor output will oscillate. Do not attempt to operate the controller if the condition exists.

P13- Voltage Boost (EB) — This potentiometer increases the Volts per Hertz (V/Hz) ratio at frequencies 20 Hertz and below. In high starting torque or

rapid acceleration applications the V/Hz ratio must be increased at low frequencies to compensate for IR losses in the motor windings. This potentiometer is factory set for zero (0) voltage boost. If the motor accelerates normally, this potentiometer should not be adjusted.

If the motor will not accelerate normally, this potentiometer must be adjusted.

Energize the controller with the motor loaded and adjust the Manual Speed potentiometer (controller mounted or remote mounted) to the maximum speed position. Turn the Voltage Boost (EB) potentiometer clockwise until the motor accelerates. Do not turn the potentiometer any further than necessary to accelerate the motor.

NOTE: If the VOLTAGE BOOST (EB) potentiometer is set too high, the controller will lock up in current limit and inhibit the acceleration ramp. If this condition occurs it will be necessary to reduce the setting of the Voltage Boost (EB) potentiometer until the motor will accelerate.

P8- Hand Minimum Reference (HMR) — This potentiometer controls the minimum speed the motor will run, when the Manual Speed potentiometer (controller mounted or remote mounted) is set at minimum level (full counterclockwise). This potentiometer is factory set to produce an output frequency of 1.25 Hertz when the Manual Speed potentiometer is set full counterclockwise. The Hand Minimum Reference (HMR) potentiometer has an adjustable range of 1.25 Hertz to 50% of the controller maximum operating frequency.

CAUTION

THIS CONTROLLER DOES NOT PROVIDE OVER-TEMPERATURE PROTECTION FOR THE MOTOR AT ALL SPEEDS OR LOADING CONDITIONS. A MOTOR THERMAL SENSOR IS RECOMMENDED.

The minimum speed is set by rotating the Manual Speed potentiometer to the minimum level (full counterclockwise) and adjusting the Hand Minimum Reference (HMR) clockwise for desired minimum motor speed. The Maximum Speed (MSD) potentiometer and snip out resistors for extended frequency range operation will affect the Hand Minimum Reference (HMR) setting, therefore the controller maximum frequency output should be preset before adjusting the Hand Minimum Reference (HMR) potentiometer.

- P9- Acceleration Time (ACC) — The potentiometer controls the amount of time for the output frequency to increase from 1.25 Hertz to 60 Hertz. The time is adjustable in two ranges, 1 to 10 seconds and 10 to 60 seconds. The timing range is controlled by a selection switch on the main control board. Refer to Section 6.1.4, Acceleration/Deceleration Time Range Selection. This potentiometer is factory set for 10 second acceleration time.

If output frequencies above 60 Hertz have been selected the acceleration timing range will change. The acceleration timing range will be:

Maximum Output Frequency Selection	Acceleration Timing Range
1.25-90 Hertz	1.5 to 15 sec. and 15 to 90 sec.
1.25-120 Hertz	2 to 20 sec. and 20 to 120 sec.

With the motor stopped, turn the Manual Speed potentiometer to the maximum setting. Start the motor and observe the length of time that it takes to accelerate to full speed. Clockwise rotation of the Acceleration Time (ACC) potentiometer increases acceleration ramp time.

- P10- Deceleration Time (DEC) — This potentiometer controls the amount of time for the output frequency to decrease from 60 Hertz to 1.25 Hertz. The Deceleration Time (DEC) potentiometer operates in the same man-

ner as the Acceleration Time (ACC) potentiometer. This potentiometer is factory set for 10 second deceleration time.

If output frequencies above 60 Hertz have been selected the deceleration timing range will change in the same manner as listed for the Acceleration Time (ACC) potentiometer.

With the motor running at full speed, stop the motor and observe the length of time that it takes to decelerate to zero speed. Clockwise rotation of the Deceleration Time (DEC) potentiometer increases deceleration time.

If a high inertia load is present two conditions could occur, if dynamic braking or regeneration unit options are not installed.

1. Deceleration time set too fast could cause an overvoltage trip. If this occurs increase the deceleration time setting.
2. The ramp modification feature will automatically override the deceleration time setting and extend the deceleration time.

- P4- Motor Current Limit (MCL) — This potentiometer limits the maximum motor running current in the range of 75-150% of the controller maximum output rated current for constant torque rated controllers. Variable torque rated controllers have an adjustment range of 60 to 120%. The Motor Current Limit (MCL) potentiometer is factory set full clockwise to allow maximum current to be delivered to the motor.

During motor starting this potentiometer setting is automatically rescaled to provide a higher current limiting range of 87-175% for constant torque controllers (70-140% for variable torque controllers). This feature maximizes motor starting torque.

If less than 150% current limit setting is required for a particular application the potentiometer can be adjusted counterclockwise.

- P5- Overload Adjust (OLA) — This potentiometer is used to set the threshold at which the overload timer will be activated. The Overload Adjust (OLA) potentiometer is factory set full clockwise which corresponds to 115% of the controller output rated current.

If the motor current exceeds 115% of the controller output rated current, an overload timer will activate and the Overload Timer (OLT) LED will light. If the controller is to be used with a motor whose full load current is less than the controller output rated current, an adjustment will be required.

CAUTION

THIS CONTROLLER DOES NOT PROVIDE OVER-TEMPERATURE PROTECTION FOR THE MOTOR AT ALL SPEEDS OR LOADING CONDITIONS. A MOTOR THERMAL SENSOR IS RECOMMENDED.

All main control board potentiometer adjustments should be made before attempting to adjust the Overload Adjust (OLA) potentiometer. The adjustment procedure must be followed:

Adjustment Procedure

- A. Start the motor
- B. Adjust the Manual Speed potentiometer for the point of maximum motor current. (This must not exceed 100% of motor nameplate current or controller rated output current)
- C. Slowly turn the Overload Adjust (OLA) potentiometer counterclockwise until the Overload Timer (OLT) LED lights.
- D. Slowly turn the Overload Adjust (OLA) potentiometer until the Overload timer (OLT) LED extinguishes.
- E. Turn Overload Adjust (OLA) potentiometer clockwise an additional 5 degrees.

Alternate Adjustment Procedure:

- A. Calculate the Overload Adjust (OLA) potentiometer voltage setting per the following method:

$$V_{OL} = \frac{M}{C} \times 10V$$

Where: V_{OL} = New voltage setting for OLA potentiometer

M = Motor Full Load Amperes (from motor nameplate)

C = Controller Maximum Output Amperes (from controller nameplate)

New Overload Adjust (OLA) voltage setting

- B. Slowly turn the Overload Adjust (OLA) potentiometer counterclockwise until the calculated new voltage setting in step A is measured between test point 12 (OV) and test point 14 (+) on the main control board. (Refer to Section 8.0 for location of test points).

The Overload Adjust (OLA) potentiometer is now set and any motor current exceeding that level will cause the controller to trip out in one minute.

- P3- Regeneration Current Limit (RCL) — This potentiometer is factory set to allow 100% (80% for variable torque controllers) regenerative current to flow from the motor if the optional dynamic braking unit is installed. If dynamic braking is not installed this potentiometer has no effect on the controller operation. If less than 100% regeneration current is required this potentiometer can be adjusted counterclockwise to lower the current limit setting.
- P12- Volts/Hertz (VHZ) — This potentiometer allows trimming of the volts per Hertz ratio of the controller output. The Volts/Hertz (P12) potentiometer is factory adjusted and sealed. **This potentiometer should not be adjusted in the field.**
- P1- Positive 10V (+10V) — This potentiometer allows adjustment of the +10 volts regulated power supply. Potentiometer (P1) is factory adjusted and sealed. **This potentiometer should not be adjusted in the field.**

- P2- Negative 10V (– 10V) — This potentiometer allows adjustment of the – 10 volt regulated power supply. Potentiometer (P2) is factory adjusted and sealed. **This potentiometer should not be adjusted in the field.**
- P15- Offset Null (OSN) - Permits cancellation of offset in the current feedback circuit to compensate for component tolerances. This potentiometer is factory adjusted and sealed. **It must not be field adjusted. Warranty will be voided if factory seal is broken.**
- P6- GAIN (GA) — Sets the gain in the current feedback circuit to compensate for component tolerances. This potentiometer is factory adjusted and sealed. **It must not be field adjusted. The warranty is voided if the seal is broken.**

6.2 OPTION BOARD ADJUSTMENTS

The adjustments of the option boards are:

VOLTAGE/CURRENT FOLLOWER SELECTION
INCOMPLETE SEQUENCE TIME SELECTION
POTENTIOMETER ADJUSTMENTS

6.2.1 VOLTAGE/CURRENT FOLLOWER SELECTION

There are three (3) option boards for use with analog input follower signals. These option boards are:

Non-Isolated Option Board (MOD A07)
Non-Isolated Option Board W/Run Relay (MOD B07)
Isolated Option Board (MOD C07)

The non-isolated option boards share the same common (reference ground) as the input signal source. An isolated option board is optically isolated from the input signal source common (reference ground). The isolated option board reduces ground currents that could otherwise occur.

These option boards will accept a wide range of analog input signals. The range of signals each will accept are:

Non-Isolated Option Board With or Without Run Relay Input signals:
0-10vdc

Isolated Option Board Input signals:

1-5 MA DC, 2-10 MA DC, 4-20 MA DC, 10-50 MA DC, 0-10 V DC or AC, 0-35 V DC or AC, 0-100 V DC or AC, 0-250 V DC or AC.

Note: Motor rotation can be controlled (on the Isolated Option Board only) by changing the polarity of the analog input follower signal. Zero to + signal causes increasing speed in the forward direction and zero to – signal causes increasing speed in the reverse direction. If this function is used snip-out Diodes D37 and D39 and Resistor R39 on the isolated option board must be removed. (Refer to Section 8.0, Snip-Out Components Placement chart, on the Option Board.)

The option boards are not factory set for any particular signal input value. After determining what signal input is desired, reposition the appropriate Option Board Selector Switch (SW1) as illustrated in Figure 6.5. (Refer to Section 8.0, Selection Switch Placement chart, Option Board, for selector switch location).

6.2.2 INCOMPLETE SEQUENCE TIME SELECTION

Option Boards (Mod B07, C07 and D07) include a sequence timing relay. This is a solid state timer with an adjustable time setting from 10 seconds to 160 seconds, in 10 second increments.

The sequence timing relay time delay can be initiated by an external contact or by starting the controller. If optional Auxiliary Sequence Relay (ASR1) (MOD T08) is installed, it will signal that the starting sequence was not successfully completed within the selected time. This timer and relay ASR1 combination is normally used to monitor external activity such as optional isolation contactor, isolation and bypass contactor operation, pump check valve sequencing and etc.

The option board sequence timing relay is not factory set for any particular time delay. After determining the desired time delay, reposition the appropriate Option Board Selector Switch (SW2) as illustrated in Figure 6.5. (Refer to Section 8.0, Selection Switch Placement chart, Option Board, for selector switch location).

FIGURE 6.5

Option Board Switch	Switch Settings															
	Auto Reference Gain Adjustment															
	Current Input								AC or DC Voltage Input							
	1-5 MA	2-10 MA	4-20 MA	10-50 MA	0-10 Volts	0-35 Volts	0-100 Volts	0-250 Volts								
SW1-1	X	O	O	O												
SW1-2	O	X	O	X												
SW1-3	O	O	X	O												
SW1-4	O	O	O	X												
SW1-5					X	X	X	O								
SW1-6					X	X	O	O								
SW1-7					X	O	X	O								
SW1-8					X	X	X	O								
Input Impedance (ohms)	1K	500	250	100	100K	350K	1.0M	2.5M								
	Incomplete Sequence Time (Seconds)															
	10	20	30	40	50	60	70	80	90	100	110	120	130	140	150	160
SW2-4	X	O	X	O	X	O	X	O	X	O	X	O	X	O	X	O
SW2-3	X	X	O	O	X	X	O	O	X	X	O	O	X	X	O	O
SW2-2	X	X	X	X	O	O	O	O	X	X	X	X	O	O	O	O
SW2-1	X	X	X	X	X	X	X	X	O	O	O	O	O	O	O	O

Typical Printed Wiring Board Switch

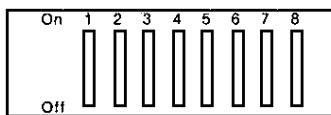

Depress this end to close (ON) switch

Depress this end to open (OFF) switch

X = Closed Switch (ON)
O = Open Switch (OFF)

FIGURE 6.6

Snip-Out Component	Function	Condition
R92 ^①	Fixed or adjustable minimum speed. Also, non-grounded or grounded follower signal transmitter.	Installed: Controller minimum speed in the automatic mode is fixed at absolute minimum speed. Also, follower signal must be isolated from ground on the transmitter end. Removed: Minimum speed in the automatic mode is adjustable (refer to Section 5.2 paragraph GGC and Section 6.2.3). Also, allows follower signal transmitter to be grounded without damage to the option board.
D37 ^② ^③ D39 R39	AC follower input or auto reversing from polarity change of input follower.	Installed: Controller will accept ac follower signal with output frequency proportional to follower signal magnitude. Removed: Signal polarity reversal. With a negative (-) to 0 to positive (+) follower signal, direction of rotation is selected by the polarity of the input signal. Positive (+) selects forward rotation, negative (-) selects reverse rotation. Output frequency is proportional to signal magnitude.

① Located on non-isolated follower boards (MOD A07, kit MC-11 and B07, kit MC-14) only.
② Located on isolated follower board (MOD C07, kit MC-12) only.
③ Refer to section 6.2.1.

6.2.3 POTENTIOMETER ADJUSTMENTS

The potentiometer adjustments were factory set as described in the initial start-up procedure for controllers with an option board. Certain potentiometers are not expected to ever require field adjustment. These have been factory sealed.

The option board potentiometer adjustment set-up procedure is described in Section 5.2 of this service bulletin. The function of each potentiometer adjustment is listed below:

- P5- (Jog/Shutdown Ref) — This potentiometer is on all option boards. It controls the jog speed when the jog at preset speed option is used or when the shutdown reference (Speed) for check valve control in pumping applications is used.

JOG FUNCTION

A Run/Jog selector switch must be added to the control circuit so that the START push button will either initiate maintained operation or a momentary Jog function for the controller.

The jog speed is adjusted by potentiometer P5 (Jog/Shutdown Ref) located on the option board. It has an adjustable range of 1.25 Hertz to 30% of the maximum output frequency. During the Jog mode of operation the acceleration and deceleration time is fixed at one second.

SHUTDOWN REF FUNCTION

If the shutdown reference (Speed) mode of operation is used, the jumper between TB1-12 (+ 10vdc) on the main control board and TB1-80 (Jog Ref) on the option board must be moved. Remove one end of the jumper from TB1-80 (Jog Ref) and re-connect to TB1-82 (Shutdown Ref) on the option board. Leave the other end of the jumper connected to TB1-12 (+ 10vdc) on the main control board.

When the controller is commanded to stop,① the Run Command Relay (RCR) is deenergized. When deenergized, this relay switches the normal speed reference signal to the shutdown speed reference signal.

The shutdown reference (Speed) is adjusted by potentiometer P5 (Jog/Shutdown Ref) located on the option board. It has an adjustable range of 1.25 Hertz to 90% of the maximum output frequency.

① If pump check valve limit switches are used the drive will continue to run until the check valve closes.

6.2.3.A ISOLATED OPTION BOARD

Both P1 (SPAN 1) and P2 (MIN SP/OFFSET) potentiometers are included on the isolated option board.

P1 (SPAN 1) — This potentiometer controls the slope or gain of the analog input follower signal. For example, an input follower signal of 4-20 ma dc can be used for automatic speed control. Normally P1 (SPAN 1) would be adjusted to provide motor rated speed at 20 ma dc input. In some applications it may be desired that motor rated speed occur at some value other than 20 ma dc input.

P1 (SPAN 1) has a span adjustment range of 40% to 140% of the nominal 20 ma input follower signal. This means that the controller can be set-up to produce motor rated speed over a range of input signal from 8 ma to 28 ma.

P2 (MIN SP/OFFSET) — This potentiometer can be used on the isolated option board as an offset adjustment as was described in Section 5.2 in live zero signal adjustments or as a minimum speed adjustment as was described in zero based signal adjustments. When used as an offset adjustment, as in the case of a 4-20 ma input, 4 ma will correspond to the absolute minimum speed (minimum controller output frequency). When used as a minimum speed adjustment, as in the case of a 0-10V dc input, 0V dc may correspond to a desired minimum speed greater than the absolute minimum speed.

P2 (MIN SP/OFFSET) has an adjustment range of zero to 30%. In the offset mode 0 to 30% of the nominal input can be adjusted to obtain absolute minimum frequency. For a 4-20 ma input, 20 ma is the nominal input value. In the minimum speed mode, 0 to 30% of rated speed can be obtained with zero input signal.

On the isolated option board, if the input signal drops below the offset setting, the option board fault LED (IL1) will light and shutdown the drive if the main control board selection switch SW4 has been set to its closed position.

6.2.3.B NON-ISOLATED OPTION BOARD (with or without Run Relay) Both P4 (SPAN 2) and P2 (MIN SP/OFFSET) potentiometers are included on the non-isolated option board.

P4 (SPAN 2) — This potentiometer controls the slope or gain of an analog input follower signal. Its function is the same as P1 (SPAN 1) on the isolated option board. The adjustment range is 60 to 160% of nominal. For example, for a 4-20 ma input, 60 to 160% of 20 ma may be adjusted for rated speed.

P2 (MIN SP/OFFSET) This potentiometer can be used on the non-isolated option board as an offset adjustment as was described in Section 5.2 (Live Zero Signal) adjustments or as a minimum speed adjustment as was described in Zero Based Signal adjustments. On the non-isolated option board, this potentiometer has an adjustment range of 0 to 40%.

Section 5.2 described two typical set-ups for the non-isolated input; 1) potentiometer input with zero based signal and 2) isolated voltage input with live zero signal. However, the non-isolated option board can be used with any of the following inputs:

- 1) Potentiometer input (5K ohm). Refer to Figure 6.7.
- 2) Isolated voltage input. Refer to Figure 6.8.
- 3) Isolated current input. Refer to Figure 6.9.

1) Potentiometer input (refer to Figure 6.7). The minimum speed adjustment for the potentiometer input was described in Section 5.2. An offset adjustment may also be made with the potentiometer input so that a given potentiometer wiper position will correspond to absolute minimum speed. To make this adjustment, turn P2 (MIN SP/OFFSET)

full CW. Apply 100% of nominal input and adjust P4 (SPAN 2) for base speed. Apply 0% of live zero reference and adjust P2 (MIN SP/OFFSET) CCW slowly until absolute minimum speed is obtained. Over adjusting P2 (MIN SP/OFFSET) will cause the speed to be non-linear with respect to wiper position.

FIGURE 6.7

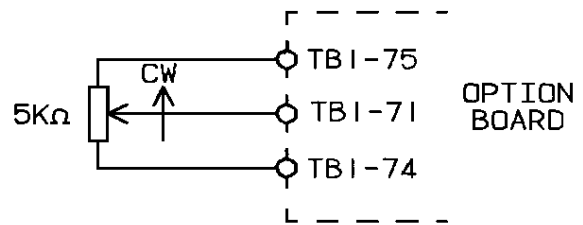

- 2) Isolated voltage input (refer to Figure 6.8). The offset adjustment was described in Section 5.2. A minimum speed adjustment may also be made with the isolated voltage input by removing snip out resistor R92 and installing a 5K ohm, 1/4W resistor between TB1-74 and TB1-75 as shown in Figure 6.8. To make the min speed adjustment, turn P2 (MIN SP/OFFSET) full CW. Calculate the desired offset voltage.

$$\text{Offset Voltage} = (100\% \text{ Zero Based Input}) \frac{(\text{Desired Min Freq})}{(\text{Base Freq})}$$

Apply an input equal to the 100% zero based input plus the calculated offset voltage. Adjust P4 (SPAN 2) until base speed is obtained. Apply 0% input from TB1-71 to TB1-74 and adjust P2 (MIN SP/OFFSET) CCW until desired minimum speed is obtained. Apply 100% zero based input and re-adjust P4 (SPAN 2) for base speed. Apply 0% zero based input and re-adjust P2 (MIN SP/OFFSET) for desired minimum speed. Several iterations may be required.

FIGURE 6.8

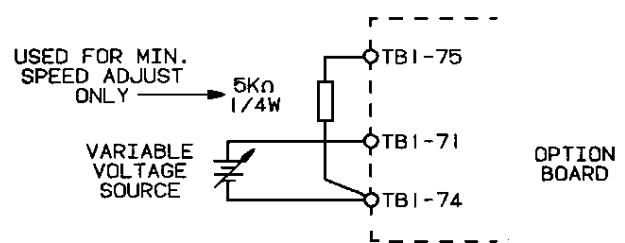

3) Isolated current input (refer to Figure 6.9). The non-isolated option board will accept a current input by connecting a 1/2W resistor between TB1-71 to TB1-74 as shown in Figure 6.9. The value of this resistor can be calculated by

$$R_I = 10 / (\text{Nominal Input Current in Amperes})$$

FIGURE 6.9

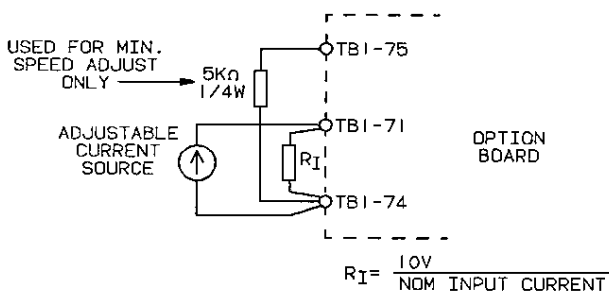

The adjustment procedure for the isolated current input is the same as the isolated voltage input.

6.2.3.C PNEUMATIC OPTION BOARD

The pneumatic option board is designed for a 3-15 PSI input. P2 (MIN SP/OFFSET) has been sealed at the factory for a 3 PSI offset. No field adjustments are necessary.

6.3 METER ADJUSTMENTS

Analog or digital speed indicating meters can be furnished factory installed on OMEGAPAK 1500 or 3500 controllers only or furnished in kit form for remote mounting.

6.3.1 Analog Speed Indicating Meter (MOD A14) (Kit Class 8804, Type AM-1) (Scale 0-100%)

STANDARD FREQUENCY RANGE (0-60 Hz) — A factory installed analog speed indicating meter is set to indicate 100% (full scale) at 60 Hertz output frequency. If the controller is to operate over the range of 0-60 Hertz no field adjustment will be necessary. A meter reading of 100% corresponds to 100% of motor rated speed.

EXTENDED FREQUENCY RANGE (0-90 Hz or 0-120 Hz) — If extended frequency range operation is selected as described in Section 6.0, Controller Adjustments, it will be

necessary to adjust the speed indicating meter calibration potentiometer on the rear of the meter. Set up the controller for the desired maximum operating speed and adjust the meter calibration potentiometer to produce a meter reading of 100%. The meter is now calibrated in percent of maximum operating speed, not percent of motor rated speed.

6.3.2 Digital Speed Indicating Meter (MOD D14) (Kit Class 8804, Type DM-1) (Scale 0-199.9 or 0-1999)

STANDARD FREQUENCY RANGE (1-60 Hz) — A factory installed digital speed indicating meter is factory set to indicate 100.0 at 60 Hertz output frequency. This corresponds to 100% of motor rated speed. If the controller is to operate over the range of 0-60 Hertz and percent of motor rated speed is the desired indication, no adjustment is necessary.

EXTENDED FREQUENCY RANGE (0-90 Hz or 0-120 Hz) — If extended frequency range operation is selected as described in Section 6.0, Controller Adjustments, the digital speed indicating meter will read out in percent of maximum operating speed to a maximum of 199.9 percent which would correspond to a controller output frequency of 120 Hertz. No adjustment is necessary.

FIGURE 6.10
PRINTED WIRING BOARD
FOR DIGITAL
INDICATING METER

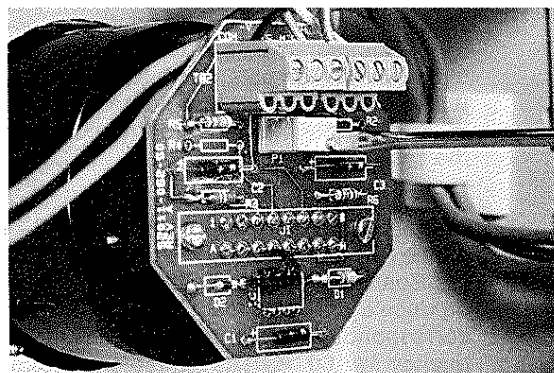

CONVERSION TO FREQUENCY READOUT

— To change calibration of the speed meter to indicating **approximate** output frequency it is only necessary to adjust the Calibration Potentiometer (P1) on the rear of the meter. With the controller operating at maximum speed as factory set (60 Hertz output), adjust the meter calibration potentiometer to produce a meter reading of 60.0. If extended frequency range is used, the meter will read properly up to maximum adjusted controller output frequency (90 or 120 Hertz).

If the controller maximum speed has been changed from the factory set maximum speed, the meter can be calibrated using a dc voltmeter. Measure the voltage between terminals MTR (+) and COM (–) on the Printed Wiring Board (see Figure 6.10) and adjust the controller Manual Speed Adjust potentiometer until the voltmeter reads exactly 2.5vdc. This voltage corresponds to 60 Hertz output. Adjust the Meter Calibration potentiometer to read 60.0

NOTE: The meter provides only a relative indication of output frequency. Operation of the slip compensation feature will cause changes in output frequency of up to $\pm 3\%$ which will not be indicated.

CONVERSION TO RPM READOUT — The digital speed meter is capable of displaying RPM over the range of 0-1999 RPM. To convert the meter to RPM readout it is necessary to clip out resistor R6 located on the Printed Wiring Board on the rear of the meter (see Figure 6.10). This disables the decimal point. The controller should then be operated at 60 Hertz and the motor speed measured with a tachometer. The Meter Calibration potentiometer located on the rear of the meter should be adjusted until the meter indication corresponds to the tachometer reading.

Alternate method — Measure the voltage between terminal MTR (+) and COM (–) on the Speed Indicating Meter Printed Wiring Board. Adjust the controller speed to produce a voltmeter reading of 2.5vdc. This corresponds to a controller operating frequency of 60 Hertz. Adjust the Meter Calibration potentiometer until the meter reads the motor rated speed as shown on the motor nameplate.

6.3.3 ANALOG VOLTMETER (MOD V15) (Kit Class 8804 Type AM-2) (Scale 0-125%)

Factory installed analog voltmeters are set to read 100% with 460 volts output from the controller. This meter operates from a 0-5 vdc signal from the controller. Meter output signals correspond to controller output voltages as follows:

$$\begin{aligned} 4 \text{ vdc} &= 460\text{V} \\ 2 \text{ vdc} &= 230\text{V} \\ 1.74 \text{ vdc} &= 200\text{V} \end{aligned}$$

If the controller is to be used on 230V or 200V systems, it will be necessary to recalibrate the meter. The meter can be calibrated by the following procedure:

1. Connect a DC Voltmeter between terminals TB1-26 (+) and TB1-31 (–) on the Main Control Board. Energize the controller and increase the output frequency until a reading of 4.0 vdc is obtained for 460V operation, 2.0 vdc is obtained for 230V operation or 1.74 vdc is obtained for 200V operation. This indicates the controller is operating at rated output voltage.
2. Adjust the potentiometer on the meter's printed wiring board, for 100% voltage output indication.
3. Remove the DC Voltmeter from the Main Control Board. The Voltmeter is now calibrated and should read all intermediate voltages accurately.

Note: Due to the complex output waveform from the controller, attempts to measure the controller output terminal voltage will produce erroneous readings and is therefore not recommended.

6.3.4 DIGITAL VOLTMETER (MOD F15) (Kit Class 8804 Type DM-1) (Scale 0-100.0%)

Follow the procedure for adjusting the analog voltmeter described in Section 6.3.3.

6.3.5 ANALOG AMMETER (MOD A15) (Kit Class 8804 Type AM-3) Scale 0-150%)

Factory installed analog ammeters are set to read 100% when the controller delivers rated output current as stamped on the controller nameplate. This meter operates from a 0-5 vdc signal from the controller (5 vdc = 150% of rated output current for

constant torque rated controllers or 120% of rated output current for variable torque rated controllers). The meter can be calibrated by the following procedure:

1. Connect a DC. Voltmeter between terminals TB1-30 (+) and TB1-31 (-) on the Main Control Board. Energize the controller, with a connected motor load, and increase the controller frequency until a reading of at least 1.0 vdc is obtained.
2. Calculate the percent controller rated output current using the following formula.
3. Percent rated current = $30 \times$ Measured voltage in Step 1 ($= 24 \times$ measured voltage for variable torque rated controllers).

4. Adjust the potentiometer on the meter's printed wiring board, for the percent rated current output indication as calculated in Step 2.

5. Remove the DC. Voltmeter from the Main Control Board. The Ammeter is now calibrated and should read all the intermediate currents accurately.

6.3.6 DIGITAL AMMETER (MOD G15) (Kit Class 8804 Type DM-1) Scale 0-150.0%.

Follow the procedure for adjusting the analog ammeter described in Section 6.3.5.

7.0 DIAGNOSTIC AND STATUS INDICATING LIGHTS

There are twenty-three (23) diagnostic and status indicating, Light Emitting Diodes (LED's) & one Neon light in a basic controller. If the controller contains optional equipment there will be LED's associated with each assembly. The LED's and Neon light are located on the following printed wiring boards:

Basic Controller:

- Main Control Board — Seventeen (17) LED's
- Gate Driver Board — One (1) LED on each board (there are a total of six (6) gate driver boards).
- Power Interface board — One (1) Neon Light

Optional Equipment:

- Non-Isolated Option Board (MOD A07) — 4 LED's
- Non-Isolated Option board W/Run Relay (MOD B07) — 4 LED's
- Isolated Option Board (MOD C07) — 7 LED's
- Pneumatic Option Board (MOD D07) — 4 LED's
- Dynamic Braking Module (MOD D09) — 3 LED's

These LED's provide a visual indication of protective functions and circuit status. When diagnosing a controller operational problem the prospective LED will illuminate to indicate what protective function was activated. There are some LED's lighted when power is applied to the controller. The function of each indicator is described in the following 7.1 through 7.5 paragraphs. (Refer to Section 8.0, LED Placement chart, Main Control Board and Option Board for location of LED's and Section 4.0, Controller Photo, for location of Neon Light.)

7.1 MAIN CONTROL BOARD LED'S

- IL1- (+ 10 V) dc power supply voltage. Should be illuminated whenever there is power applied to the controller.
- IL2- (- 10 V) dc power supply voltage. Should be illuminated whenever there is power applied to the controller.

- IL3- Undervoltage (UV). Will illuminate whenever line voltage to the controller is less than 87.5% of the rated voltage. This LED will extinguish when line voltage is 95% of the rated voltage.
- IL4- Overvoltage (OV). Will illuminate whenever the bus voltage exceeds 900vdc or 450vdc, the level is determined by the System Voltage Selection switch (SW6). To extinguish this LED will require the controller to be reset.
- IL5- Shoot Through (ST). Will illuminate when the dc bus voltage falls below 100v or 50v, the level being determined by the system voltage selection switch (SW6). To extinguish this LED will require the controller to be reset.
- IL6- Ground Fault (GF). Will illuminate when there is current flowing from the controller output to ground. When ground current is detected, trip out will be instantaneous. To extinguish this LED will require the controller to be reset.
- IL7- Instantaneous Overcurrent (IOC). Will illuminate when there is 180% of the controller peak maximum output rated current sensed by the output current transformers. To extinguish this LED will require the controller to be reset.
- IL8- Overload (OLD). Will illuminate when the controller output current has exceeded the current setting of the Overload Adjustment Potentiometer (P5) for one minute. To extinguish this LED will require the controller to be reset.
- IL9- Overtemperature (OT) and precharge contactor failure. Will illuminate if the controller is subject to excessive ambient temperature or upon loss of cooling air. Will also illuminate if the precharge contactor fails to pick up when power is applied to the controller. To extinguish this LED will require the controller to be reset.
- IL10- Option Fault (OF). Will illuminate when a fault occurs on the option board, dynamic braking option, or regeneration controller option. If option fault selection switch (SW4) is closed any of

these faults will cause a controller lockout, and a controller reset will be required to extinguish the LED. If option fault selection switch (SW4) is open (IL10) will illuminate, but the controller will not shut-down and lockout.

IL11- The Overload Timer LED (OLT). Illuminates whenever the controller output current exceeds the level determined by potentiometer P5 (overload adjust). If this level is exceeded for 1 minute the controller faults on Overload (OLD) and the Overload (OLD) LED (IL8) will light. It is important to recognize that the overload timing circuitry has an electronic memory characteristic much as a thermal overload unit possesses a thermal memory. The memory characteristic functions such that it requires approximately the same amount of time for the timer to reset as was required to accumulate that amount of time. For example, after faulting on OLD approximately 1 minute is required to reset the timer. If the Main Control Board fault reset button was depressed 10 seconds after faulting on OLD and the controller was started with an overload condition present (IL11 illuminated) it would be only 10 seconds before the controller faulted on OLD (as opposed to 60 seconds initially). Along the same lines the OLT (IL11) does not have to be activated continuously for 60 seconds, but rather, must only average on for 60 seconds. The above comments relating to the electronic memory characteristic are valid only if power to the controller is not removed and reapplied. The removal of power from the controller results in the immediate reset of the OLT.

IL12- Power Up Delay (PUD). Illuminates nominally for 1.5 seconds when power is initially applied to the controller. During controller power up the shoot through fault and the overvoltage circuit is disabled.

IL13- Drive Lockout (DL). Will illuminate whenever a fault occurs that requires a controller reset. The controller can be set-up to lockout on either one or two faults by a snipout resistor (R172).

IL14- Regenerating (REG). Illuminates whenever power flow is from the motor to the controller. Regenerative power flow will occur when decelerating high inertia loads or controlling overhauling loads.

IL15- Regenerating Current Limit (RCL). Will illuminate whenever the current from the motor is at the level determined by the Regeneration Current Limit Adjustment Potentiometer (P3).

IL16- Motor Current Limit (MCL). Will illuminate whenever the current to the motor is at the level determined by the Motor Current Limit Adjustment Potentiometer (P4).

IL17- Drive Enable (DE). Will illuminate whenever the drive run relay (DRR) and run command relay (RCR) are both energized.

7.2 GATE DRIVER BOARD LED

IL1- This LED will not illuminate until the controller is operating. During controller operation the LED will illuminate continuously.

7.3 POWER INTERFACE BOARD NEON

IL1- This Neon indicates presence of dc bus voltage at the inverter. This Neon should be illuminated anytime power is applied to the controller. The Neon will remain illuminated after power is removed from the controller until the voltage across the dc bus is less than 100vdc.

7.4 OPTIONS BOARD LED'S

IL1⊕ -(Fault). The purpose of this LED is to indicate loss of voltage or current follower signal. If the input follower signal drops below the Min SP/Offset Adjustment Potentiometer (P2) setting (if minimum speed is 1.25 Hertz), this LED will illuminate. To extinguish the LED will require the input follower signal to be restored and the controller to be reset.

IL2⊕ -(+VISO) dc power supply voltage. Should be illuminated whenever there is power applied to the controller.

- IL3^① - (- VISO) dc power supply voltage. Should be illuminated whenever there is power applied to the controller.
 - IL4- (Jog). Will illuminate whenever the Jog mode of operation is selected.
 - IL5- (Auto). Will illuminate whenever the automatic mode of operation is selected.
 - IL6- (Shutdown). Will illuminate whenever the shutdown speed reference is selected.
 - IL7- (Hand). Will illuminate whenever the Hand mode of operation is selected.
- ① Present on Isolated Option Board.

7.5 DYNAMIC BRAKING MODULE LED'S

- IL1- Will not illuminate until dynamic braking action is necessary to reduce motor speed. (This LED is located on the plug-in Gate Driver Board.)
- IL1- (IOC). Instantaneous Overcurrent. Will illuminate whenever the dynamic braking current is at or above the instantaneous trip level. Resetting the controller will extinguish this LED.
- IL2- (Overload). Will illuminate whenever the dynamic braking current is above the long term trip level for a time which could cause damage to the DB Module. Resetting the controller will extinguish this LED.

7.6 STAND-BY MODE LAMP STATUS

There are a large variety of possible lamp indications while the controller is operating, however it is possible to predict the condition of most of the lamps while in a stand-by condition. Standby is defined as "Power applied with the drive stopped". The following tabulation contains the lamp conditions for the stand-by mode.

Lamps	Main Control Board	On	Off	Indeterminate	Comments
IL1		X			
IL2		X			
IL3			X		May flicker momentarily when power is applied
IL4			X		
IL5			X		
IL6			X		
IL7			X		
IL8			X		
IL9			X		
IL10			X		
IL11			X		May glow dimly with no over-load present
IL12			X		Illuminates for approximately 1.5 sec when power is applied and then extinguishes
IL13			X		
IL14			X	X	May change states randomly
IL15			X		
IL16			X		
IL17			X		
Gate Driver Board					
IL1			X		6 of these/1 for each gate driver
Power Interface Board Neon					
			X		
Option Boards LEDs					
IL1			X		
IL2		X			Both IL2 and IL3 are illuminated for C07 (MC-12). Lamps are not present on A07, B07, D07 (MC-11, MC-13, ML-14)
IL3		X			
IL4				X	These 4 depend on external select logic
IL5				X	
IL6				X	
IL7				X	
Dynamic Braking Module					
IL1 (Gate Driver)			X		
IL1 (Dynamic Brake Board)			X		
IL2 (Dynamic Brake Board)			X		Only present on 50-100 HP constant torque rated controllers

8.0 POTENTIOMETER, SELECTION SWITCH, LED & SNIP-OUT COMPONENT PLACE-
MENT CHART

8.1 MAIN CONTROL BOARD

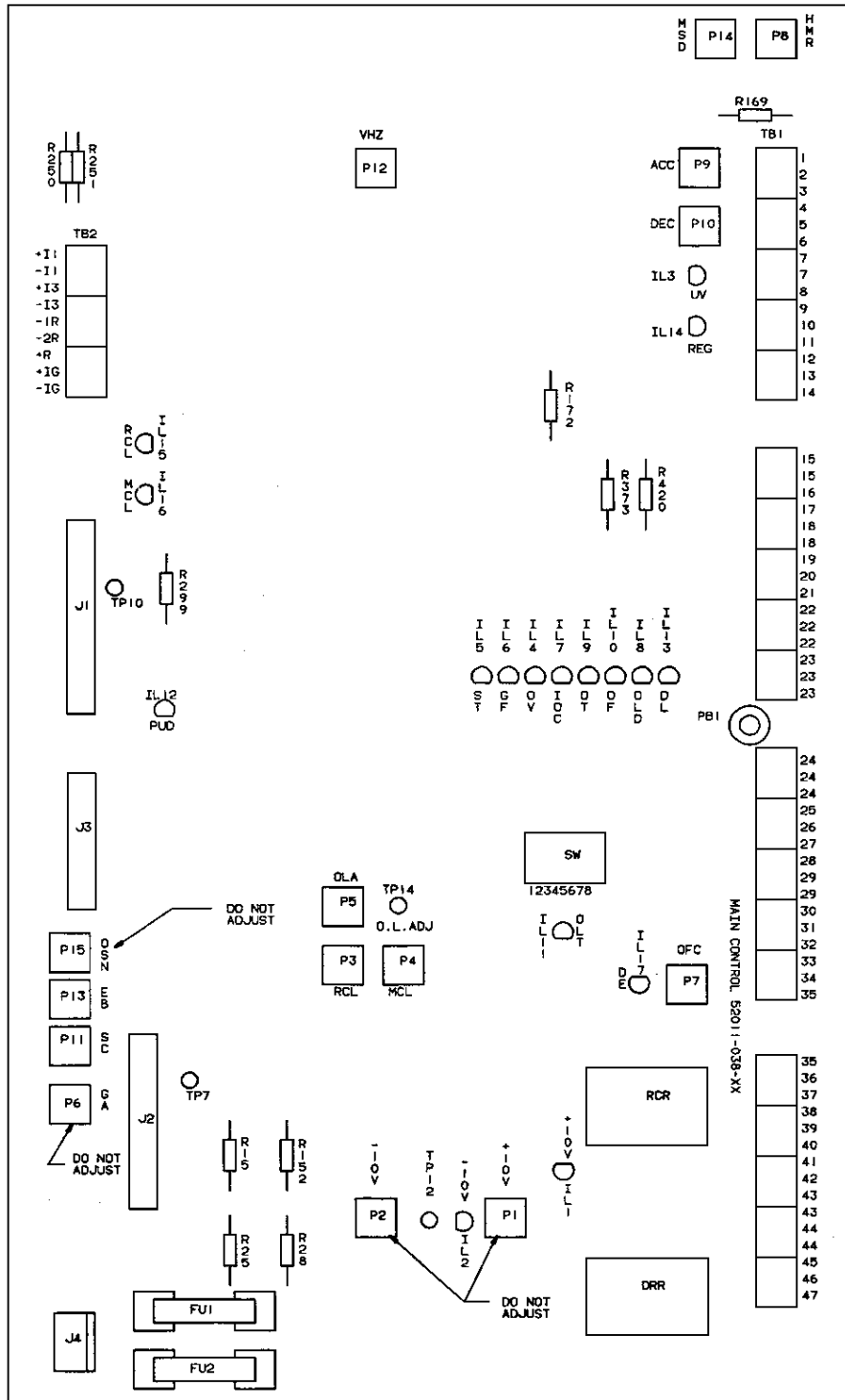

8.2 OPTION BOARD

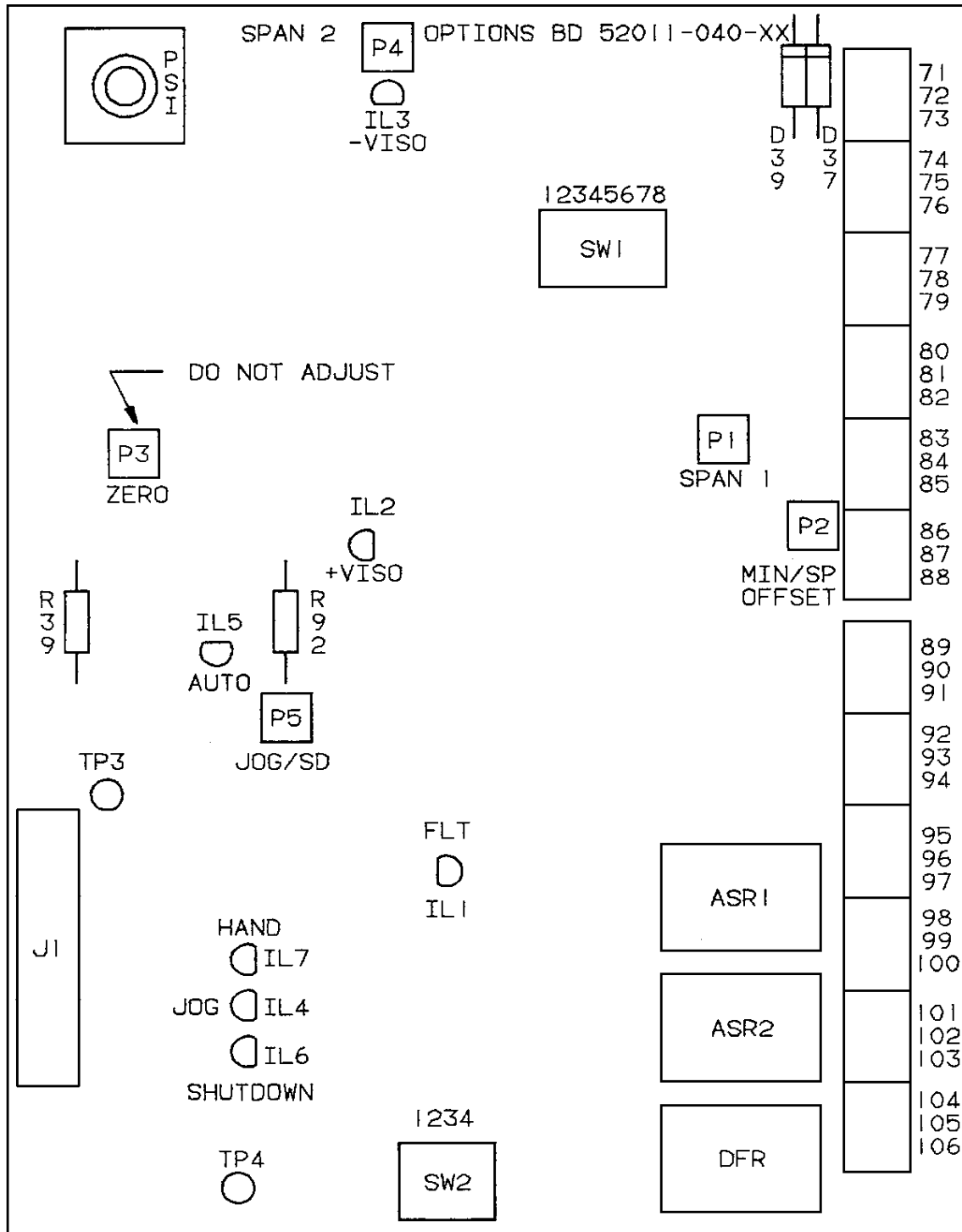

9.0 CONTROLLER OPERATION

9.1 BLOCK DIAGRAM DESCRIPTION

FIGURE 9.1
OMEGAPAK CONTROLLER
BLOCK DIAGRAM

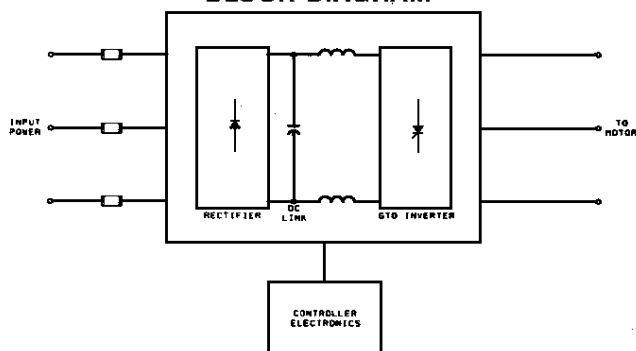

RECTIFIER

The rectifier section consists of six power diodes arranged in a three phase, full wave bridge configuration. Its purpose is to change fixed voltage, fixed frequency ac voltage to dc voltage.

DC LINK

The dc link couples the rectifier output to the inverter input. The dc link includes capacitors to smooth the voltage present on the rectifier output plus inductors to limit the rate of change of current during output short circuit conditions.

INVERTER

The inverter section consists of six Gate Turn-Off (GTO) Thyristors which, under control of the OMEGAPAK controller electronics, reconstruct a three phase ac waveform for application to a standard three phase ac motor. A Sine Coded Pulse Width Modulation (PWM) switching technique is used.

Section 11, drawing 11.1.1 details the controller power circuit.

CONTROLLER ELECTRONICS

Electronic circuitry located on a main control board generates all signals necessary to control the turn-on and turn-off of the Inverter GTOs for controlling the output frequency and voltage. The electronics also contains circuitry to protect the controller against various fault conditions and Light Emitting Diodes (LEDs) to indicate controller status. Refer to Section 11, Drawing

11.7.3 for a block diagram of the controller electronics.

9.2 CONTROL CIRCUIT SEQUENCE

The flexibility of available pilot devices to control the OMEGAPAK controller makes possible a wide range of control circuit sequences. The descriptions of operation have been limited to those which are most commonly used.

9.2.1 Pilot Lights, Elapsed Time Meter and Heat Sink Fan(s)

For pilot lights, elapsed time meter and heat sink fan control circuit sequence, refer to Section 11.0, diagram 11.2.6 and the description below.

MOD P16

The Power On light (if used) will illuminate when power is applied to the controller.

MOD R16

The Run light (if used) will illuminate when the Drive Run Relay (DRR) N.O. contact closes. This same relay contact will also energize the heat sink fan relay.

MOD F16

The Drive Fail light (if used) will illuminate when the Drive Fail Relay (DFR) (if used) N.C. contact closes. This light is normally not lighted until a controller protective circuit has caused an abnormal shutdown, dropping out the drive fail relay (DFR).

MOD S16

The Incomplete Sequence light (if used) will illuminate when the Auxilliary Sequence Relay 1 (ASR1) (if used) N.O. contact closes. If the controller has been unable to successfully complete the start sequence in a time less than the Incomplete Sequence Timer setting, relay (ASR1) will be energized.

MOD T15

The Elapsed Time Meter (if used) will be energized when the Drive Run Relay (DRR) N.O. contact closes.

9.2.2 Start-Stop Push Buttons and Manual Speed Potentiometer (MOD S10) (Class 9001, Type CA-31 Assembled Control Station)

For operation of the control circuit sequence, refer to Section 11.0, diagram 11.2.1 and the description below:

Starting Sequence

A. Pressing the Start push button will energize the Run Command Relay (RCR) causing the following:

- 1) The RCR N.O. contact between terminals 40 and 36 will close to seal around the Start push button.
- 2) The RCR N.C. contact between terminal 38 and the Shutdown Enable input opens removing the negative voltage ($-V$ unreg.) from the Shutdown Enable input causing the controller to switch from the shutdown mode.
- 3) The RCR N.O. contact between terminal 38 and the Drive Run Relay (DRR) N.O. closes preparing to enable the controller when the DRR N.O. contact closes.
- 4) The RCR N.O. contact between terminals 44 and 41 closes to energize the Drive Run Relay (DRR).

B. Energizing the DRR causes the following:

- 1) The DRR N.O. contact between RCR N.O. and the Drive Enable input closes applying $-V$ unreg. to the enable input to place the electronics in the run mode.
- 2) The DRR N.O. contact between terminal 44 and the DRR coil closes to seal around RCR.

C. The controller should now be operating with the output frequency controlled by the manual speed potentiometer.

Normal Stopping Sequence

A. Pressing the Stop push button deenergizes the RCR causing the following:

- 1) The RCR N.O. contact between terminals 40 and 36 opens to break the seal around the Start push button.
- 2) The RCR N.O. contact between terminal 38 and the DRR N.O. opens to take the electronics out of the run mode.
- 3) The RCR N.C. contact between terminal 38 and the Shutdown Enable input closes causing the controller

to switch to the shutdown mode and begin ramping the output frequency to minimum.

- 4) The RCR N.O. contact between terminals 44 and 41 opens, removing the pick-up circuit from the DRR. Note DRR does not drop out due to the seal in contact.

B. When the deceleration ramp has returned the output frequency to minimum, the electronic circuitry will pulse the silicon controlled rectifier (SCR) in parallel with the DRR coil to drop out the DRR.

C. The controller is now stopped.

Abnormal Stopping Sequence

A. Operation of a protective circuit will cause immediate controller shutdown upon occurrence of a fault condition. The electronic circuitry will trigger the SCRs in parallel with the RCR and DRR coils and keep them triggered until the controller is reset.

B. The RCR and DRR relays will drop out returning all contacts to their deenergized state.

C. The controller will stop immediately and the motor will coast to a stop.

9.2.3 Hand-Automatic Selector Switch, Start-Stop Push Buttons and Manual Speed Potentiometer (Mod. No. A10) (Class 9001, Type CA-42 Assembled Control Station)

For operation of the control circuit sequence, refer to Section 11.0, diagram 11.2.2 and the description below:

Hand Mode

A. Placing the Hand-Auto (H-A) Selector Switch in the Hand position causes the following:

- 1) Opens the circuit between terminals 91 and 34 disabling the automatic start contacts.
- 2) Closes the circuit between terminal 89 and the Stop push button enabling the Start-Stop push buttons.
- 3) Opens the circuit between terminal 22 ($-V$ unreg.) and terminal 78 (Hand/Auto) reference select on

the option board to switch control of the output frequency to the manual speed potentiometer.

- 4) Closes the circuit between terminals 22 (-V unreg.) and 16 (RCR Short Pulse) to momentarily pulse the SCR in parallel with the Run Command Relay. This ensures that the RCR will drop out and cause a controller shutdown if switching from the Auto to Hand modes.

Starting Sequence

A. Pressing the Start push button will energize the Run Command Relay (RCR) causing the following:

- 1) The RCR N.O. contact between terminals 40 and 36 will close to seal around the Start push button.
- 2) The RCR N.C. contact between terminal 38 and the Shutdown Enable input opens removing the negative voltage (-V unreg.) from the Shutdown Enable input causing the controller to switch from the shutdown mode.
- 3) The RCR N.O. contact between terminal 38 and the Drive Run Relay (DRR) N.O. closes preparing to enable the controller when the DRR N.O. contact closes.
- 4) The RCR N.O. contact between terminals 44 and 41 closes to energize the Drive Run Relay (DRR).

B. Energizing the DRR causes the following:

- 1) The DRR N.O. contact between RCR N.O. and the Drive Enable input closes applying -V unreg. to the enable input to place the electronics in the run mode.
- 2) The DRR N.O. contact between terminal 44 and the DRR coil closes to seal around RCR.

C. The controller should now be operating with the output frequency controlled by the manual speed potentiometer.

Normal Stopping Sequence

A. Pressing the Stop push button deenergizes the RCR causing the following:

- 1) The RCR N.O. contact between terminals 40 and 36 opens to break the seal around the Start push button.

- 2) The RCR N.O. contact between terminal 38 and the DRR N.O. opens to take the electronics out of the run mode.

- 3) The RCR N.C. contact between terminal 38 and the Shutdown Enable input closes causing the controller to switch to the shutdown mode and begin ramping the output frequency to minimum.

- 4) The RCR N.O. contact between terminals 44 and 41 opens, removing the pick-up circuit from the DRR. Note DRR does not drop out due to the seal in contact.

B. When the deceleration ramp has returned the output frequency to minimum, the electronic circuitry will pulse the Silicon Controlled Rectifier (SCR) in parallel with the DRR coil to drop out the DRR.

C. The controller is now stopped.

Abnormal Stopping Sequence

A. Operation of a protective circuit will cause immediate controller shutdown upon occurrence of a fault condition. The electronic circuitry will trigger the SCRs in parallel with the RCR and DRR coils and keep them triggered until the controller is reset.

B. The RCR and DRR relays will drop out returning all contacts to their deenergized state.

C. The controller will stop immediately and the motor will coast to a stop.

Auto Mode

A. Placing the Hand-Auto (H-A) selector switch in the Auto position causes the following:

- 1) Opens the circuit between terminal 89 and the Stop push button disabling the Start-Stop push buttons.
- 2) Closes the circuit between terminals 91 and 34 enabling the automatic start contact.
- 3) Closes the circuit between terminal 22 (-V unreg.) and terminal 78 (Hand/Auto) reference select on the option board to switch control of the output frequency to an analog input follower signal.

- 4) Opens the circuit between terminals 22 (- V unreg.) and 16 (RCR SHORT PULSE) to prevent triggering of the RCR shorting SCR.

Start Sequence

A. Closing the user supplied contact between terminals 44 and 91 energizes the Run Command Relay (RCR). NOTE: On option boards so equipped, a 4 to 33vdc signal can be used to pickup a Solid State Run Relay (RR) to start the controller. Refer to the option boards connection diagram for input terminals for the 4 to 33vdc signal. Energizing the RCR causes the following:

- 1) The RCR N.O. contact between terminals 40 and 36 closes but has no effect since power to the Stop push button has been disabled.
- 2) The RCR N.C. contact between terminal 38 and the Shutdown Enable input opens removing the negative voltage (- V unreg.) from the Shutdown Enable input causing the controller to switch from the shutdown mode.
- 3) The RCR N.O. contact between terminal 38 and the Drive Run Relay (DRR) N.O. closes preparing to enable the controller when the DRR N.O. contact closes.
- 4) The RCR N.O. contact between terminals 44 and 41 closes to energize the Drive Run Relay (DRR).

B. Energizing the DRR causes the following:

- 1) The DRR N.O. contact between RCR N.O. and the Drive Enable input closes applying -V unreg. to the enable input to place the electronics in the run mode.
- 2) The DRR N.O. contact between terminal 44 and the DRR coil closes to seal around RCR.

C. The controller should now be operating with the output frequency controlled by the analog input follower signal.

Normal Stopping Sequence

A. Opening the automatic start contact deenergizes the RCR causing the following:

- 1) The RCR N.O. contact between terminals 40 and 36 opens, however, this contact has no effect in the auto mode.
- 2) The RCR N.O. contact between terminal 38 and the DRR N.O. opens to take the electronics out of the run mode.
- 3) The RCR N.C. contact between terminal 38 and the Shutdown Enable input closes causing the controller to switch to the shutdown mode and begin ramping the output frequency to minimum.
- 4) The RCR N.O. contact between terminals 44 and 41 opens, removing the pick-up circuit from the DRR. Note DRR does not drop out due to the seal in contact.

B. When the deceleration ramp has returned the output frequency to minimum, the electronic circuitry will pulse the silicon controlled rectifier (SCR) in parallel with the DRR coil to drop out the DRR.

C. The controller is now stopped.

Abnormal Stopping Sequence

A. Operation of a protective circuit will cause immediate controller shutdown upon occurrence of a fault condition. The electronic circuitry will trigger the SCRs in parallel with the RCR and DRR coils and keep them triggered until the controller is reset.

B. The RCR and DRR relays will drop out returning all contacts to their deenergized state.

C. The controller will stop immediately and the motor will coast to a stop.

9.2.4 Hand-Off-Automatic selector switch, and Manual Speed potentiometer (Mod. No. H10)

For operation of the control circuit sequence, refer to Section 11.0, diagram 11.2.3 and the description below:

Hand Mode

A. Placing the Hand-Off-Auto (H-O-A) selector switch in the Off position disables controller operation.

B. Placing the Hand-Off-Auto (H-O-A) selector switch in the Hand position causes the following:

- 1) The H-O-A contact between terminals 91 and 34 opens disabling the Automatic Start contact.
- 2) The H-O-A contact between terminals 22 (- V unreg.) and 78 (Hand-Auto) located on an option board opens causing the output frequency to respond to the manual speed potentiometer.
- 3) The H-O-A contact between terminals 89 and 34 closes, energizing the Run Command Relay (RCR) coil. If the H-O-A switch is rapidly moved from Auto to Hand, the RCR will momentarily drop out but will immediately pick up and the controller will continue to operate but with the speed controlled by the manual speed potentiometer.

C. Energizing RCR causes the following:

- 1) The RCR N.C. contact between terminal 38 and the Shutdown Enable input opens removing the negative voltage (- V unreg.) from the Shutdown Enable input causing the controller to switch from the shutdown mode.
- 2) The RCR N.O. contact between terminal 38 and the Drive Run Relay (DRR) N.O. closes preparing to enable the controller when the DRR N.O. contact closes.
- 3) The RCR N.O. contact between terminals 44 and 41 closes to energize the Drive Run Relay (DRR).

D. Energizing the DRR causes the following:

- 1) The DRR N.O. contact between RCR N.O. and the Drive Enable input closes applying - V unreg. to the enable input to place the electronics in the run mode.
- 2) The DRR N.O. contact between terminal 44 and the DRR coil closes to seal around RCR.

E. The controller should now be operating with the output frequency controlled by the manual speed potentiometer.

Normal Stopping Sequence

A. Moving the H-O-A selector switch to the Off position deenergizes the RCR causing the following:

- 1) The RCR N.O. contact between terminal 38 and the DRR N.O. opens to take the electronics out of the run mode.
- 2) The RCR N.C. contact between terminal 38 and the Shutdown Enable input closes causing the controller to switch to the shutdown mode and begin ramping the output frequency to minimum.
- 3) The RCR N.O. contact between terminals 44 and 41 opens, removing the pick-up circuit from the DRR. Note DRR does not drop out due to the seal in contact.

B. When the deceleration ramp has returned the output frequency to minimum, the electronic circuitry will pulse the silicon controlled rectifier (SCR) in parallel with the DRR coil to drop out the DRR.

C. The controller is now stopped.

Abnormal Stopping Sequence

A. Operation of a protective circuit will cause immediate controller shutdown upon occurrence of a fault condition. The electronic circuitry will trigger the SCRs in parallel with the RCR and DRR coils and keep them triggered until the controller is reset.

B. The RCR and DRR relays will drop out returning all contacts to their deenergized state.

C. The controller will stop immediately and the motor will coast to a stop.

Auto Mode

A. Placing the Hand-Off-Auto (H-O-A) selector switch in the Auto mode causes the following:

- 1) The H-O-A contact between terminals 91 and 34 closes to enable the controller to start when the automatic start contact closes.
- 2) The H-O-A contact between terminals 89 and 34 opens preventing the controller from being manually started.

- 3) The H-O-A contact between terminals 22 (– V unreg.) and 78 (Hand-Auto) located on an options card closes causing the output frequency to respond to an analog input follower signal.
- B. Closing the automatic start contact energizes the Run Command Relay (RCR) causing the following:
- 1) The RCR N.C. contact between terminal 38 and the Shutdown Enable input opens removing the negative voltage (– V unreg.) from the Shutdown Enable input causing the controller to switch from the shutdown mode.
 - 2) The RCR N.O. contact between terminals 38 and the Drive Run Relay (DRR) N.O. closes preparing to enable the controller when the DRR N.O. contact closes.
 - 3) The RCR N.O. contact between terminals 38 and the Drive Run Relay (DRR) N.O. closes preparing to enable the controller when the DRR N.O. contact closes.
 - 4) The RCR N.O. contact between terminals 44 and 41 closes to energize the Drive Run Relay (DRR).
- C. Energizing the DRR causes the following:
- 1) The DRR N.O. contact between RCR N.O. and the Drive Enable input closes applying – V unreg. to the enable input to place the electronics in the run mode.
 - 2) The DRR N.O. contact between terminal 44 and the DRR coil closes to seal around RCR.
- D. The controller should now be operating with the output frequency controlled by the analog input follower signal.

Normal Stopping Sequence

- A. Opening the automatic start contact or moving the H-O-A switch to the OFF position deenergizes the RCR causing the following:
- 1) The RCR N.O. contact between terminal 38 and the DRR N.O. opens to take the electronics out of the run mode.

- 2) The RCR N.C. contact between terminal 38 and the Shutdown Enable input closes causing the controller to switch to the shutdown mode and begin ramping the output frequency to minimum.
- 3) The RCR N.O. contact between terminals 44 and 41 opens, removing the pick-up circuit from the DRR. Note DRR does not drop out due to the seal in contact.

- B. When the deceleration ramp has returned the output frequency to minimum, the electronic circuitry will pulse the silicon controlled rectifier (SCR) in parallel with the DRR coil to drop out the DRR.

- C. The controller is now stopped.

Abnormal Stopping Sequence

- A. Operation of a protective circuit will cause immediate controller shutdown upon occurrence of a fault condition. The electronic circuitry will trigger the SCRs in parallel with the RCR and DRR coils and keep them triggered until the controller is reset.
- B. The RCR and DRR relays will drop out returning all contacts to their deenergized state.
- C. The controller will stop immediately and the motor will coast to a stop.

9.2.5. Start-Stop Push buttons, Fast Stop Push button, Manual Speed Potentiometer (MOD F10), Forward Reverse Selector Switch, Run-Jog Selector Switch (MOD F11, J11)

For operation of the control circuit sequence, refer to Section 11.0, diagram 11.2.4 and the description below:

Forward-Reverse Selection

Selection of forward or reverse rotation is independent of Start-Stop or Run-Jog functions and is described separately.

- A. Placing the Forward-Reverse selector switch in the Forward position opens the contact between terminals 22 (– V unreg.) and 27 (Reverse) causing the output frequency to assume an A, B, C phase rotation.
- B. Placing the Forward-Reverse selector

switch in the Reverse position closes the contact between terminals 22 (– V unreg.) and 27 (Reverse) causing the output frequency to electronically reverse phase rotation.

- C. Moving the Forward-Reverse selector switch from Forward to Reverse or Reverse to Forward while the controller is operating is permissible. The controller will decelerate to minimum frequency under control of the deceleration ramp, electronically switch phase rotation and accelerate back to the set speed under control of the acceleration ramp.

Run Mode

- A. Placing the Run-Jog selector switch in the Run position causes the following:
- 1) The Run-Jog switch contact between the Stop push button and terminal 40 closes permitting the Run Command Relay (RCR) N.O. contact to seal around the Start push button.
 - 2) The contact between terminals 22 (– V unreg.) and 79 (Jog Select) opens causing the output frequency to respond to the manual speed potentiometer.
- B. Pressing the Start push button will energize the Run Command Relay (RCR) causing the following:
- 1) The RCR N.O. contact between terminals 40 and 36 will close to seal around the Start push button through the closed Run-Jog selector switch contact.
 - 2) The RCR N.C. contact between terminal 38 and the Shutdown Enable input opens removing the negative voltage (– V unreg.) from the Shutdown Enable input causing the controller to switch from the shutdown mode.
 - 3) The RCR N.O. contact between terminal 38 and the Drive Run Relay (DRR) N.O. closes preparing to enable the controller when the DRR N.O. contact closes.
 - 4) The RCR N.O. contact between terminals 44 and 41 closes to energize the Drive Run Relay (DRR).

- C. Energizing the DRR causes the following:

- 1) The DRR N.O. contact between RCR N.O. and the Drive Enable input closes applying – V unreg. to the enable input to place the electronics in the run mode.
- 2) The DRR N.O. contact between terminal 44 and the DRR coil closes to seal around RCR.

- D. The controller should now be operating with the output frequency controlled by the manual speed potentiometer.

Normal Stopping Sequence

- A. Pressing the Stop push button deenergizes the RCR causing the following:

- 1) The RCR N.O. contact between terminals 40 and 36 opens to break the seal around the Start push button.
- 2) The RCR N.O. contact between terminal 38 and the DRR N.O. opens to take the electronics out of the run mode.
- 3) The RCR N.C. contact between terminal 38 and the Shutdown Enable input closes causing the controller to switch to the shutdown mode and begin ramping the output frequency to minimum.
- 4) The RCR N.O. contact between terminals 44 and 41 opens, removing the pick-up circuit from the DRR. Note DRR does not drop out due to the seal in contact.

- B. When the deceleration ramp has returned the output frequency to minimum, the electronic circuitry will pulse the silicon controlled rectifier (SCR) in parallel with the DRR coil to drop out the DRR.

- C. The controller is now stopped.

Fast Stop

- A. Pressing the Fast Stop push button opens the circuit between terminals 22 (– V unreg.) and 3 (Fast Stop) causing the output frequency to ramp to minimum frequency as quickly as possible regardless of the time setting of the Deceleration Ramp Potentiometer. If optional Dynamic Braking or Regenerative

Braking is used, the minimum ramp time will be 1 second for 60 Hertz operation (2 seconds for 120 Hertz). If DB or REGEN are not used, the minimum ramp time will be determined by the load inertia.

- B. When the output frequency reaches minimum, the electronic circuitry will pulse the SCR in parallel with RCR and DRR causing them to drop out.
- C. The controller is now stopped.

Abnormal Stopping Sequence

- A. Operation of a protective circuit will cause immediate controller shutdown upon occurrence of a fault condition. The electronic circuitry will trigger the SCRs in parallel with the RCR and DRR coils and keep them triggered until the controller is reset.
- B. The RCR and DRR relays will drop out returning all contacts to their deenergized state.
- C. The controller will stop immediately and the motor will coast to a stop.

Jog Mode

- A. Placing the Run-Jog selector switch in the Jog position causes the following:
 - 1) The Run-Jog switch contact between the Stop push button and terminal 40 opens breaking the seal-in path for the Run Command Relay (RCR).
 - 2) The Run-Jog switch contact between terminals 22 (- V unreg.) and 79 (Jog Select) closes to enable the jog speed reference on the option board. Jog speed is controlled by the jog speed adjust potentiometer. NOTE: If an option board is not used, the controller will jog at the speed set by the manual speed potentiometer.
- B. Pressing the Start push button will energize the Run Command Relay (RCR) causing the following:
 - 1) The RCR N.O. contact between terminals 40 and 36 will close to seal around the Start push button but the seal-in path is broken by the open Run-Jog selector switch contact.

- 2) The RCR N.C. contact between terminal 38 and the Shutdown Enable input opens removing the negative voltage (- V unreg.) from the Shutdown Enable input causing the controller to switch from the shutdown mode.
 - 3) The RCR N.O. contact between terminal 38 and the Drive Run Relay (DRR) N.O. closes preparing to enable the controller when the DRR N.O. contact closes.
 - 4) The RCR N.O. contact between terminals 44 and 41 closes to energize the Drive Run Relay (DRR).
- C. Energizing the DRR causes the following:
- 1) The DRR N.O. contact between RCR N.O. and the Drive Enable input closes applying - V unreg. to the enable input to place the electronics in the run mode.
 - 2) The DRR N.O. contact between terminal 44 and the DRR coil closes to seal around RCR.
 - 3) If an option board is used, the output frequency follows the minimum ramp time (1 sec) to the setting called for by the jog pre-set speed potentiometer.
 - 4) If an option board is not used, the output frequency follows the normal acceleration ramp time to the setting called for by the manual speed potentiometer.
- D. Releasing the Start push button deenergizes the RCR causing the following:
- 1) The RCR N.O. contact between terminal 38 and the DRR N.O. opens to take the electronics out of the run mode.
 - 2) The RCR N.C. contact between terminal 38 and the Shutdown Enable input closes causing the controller to switch to the shutdown speed reference and begin ramping the output frequency to minimum.
 - 3) The RCR N.O. contact between terminals 44 and 41 opens, removing the pick-up circuit from the DRR. Note DRR does not drop out due to the seal in contact.

- 4) If an option board is used, the output frequency follows the minimum ramp time (1 second) to minimum frequency.
- 5) If an option board is not used, the output frequency follows the normal deceleration time ramp to minimum frequency.

E. When the deceleration ramp has returned the output frequency to minimum, the electronic circuitry will pulse the silicon controlled rectifier (SCR) in parallel with the DRR coil to drop out the DRR.

F. The controller is now stopped.

Abnormal Stopping Sequence

- A. Operation of a protective circuit will cause immediate controller shutdown upon occurrence of a fault condition. The electronic circuitry will trigger the SCRs in parallel with the RCR and DRR coils and keep them triggered until the controller is reset.
- B. The RCR and DRR relays will drop out returning all contacts to their deenergized state.
- C. The controller will stop immediately and the motor will coast to a stop.

9.2.6 OMEGAPAK 3500 controller with optional Isolation Contactor (Mod C13) or optional Isolation/Bypass Contactor (Mod B13 or D13) and Hand-Off-Auto Selector Switch and Manual Speed Potentiometer (Mod H10), and Option Board relays (Mod's F08, T08, S08).

For operation of the control circuit sequence, refer to Section 11.0 diagram 11.2.5 and the description below

Operation With Isolation Contactor

(Diagram 11.2.5) Note: AFC-Off-Line switch is not used and a jumper is installed between terminals 22 and 3.

Hand Mode

- A. Placing the Hand-Off-Auto (H-O-A) selector switch in the Hand position causes the following:
 - 1) The H-O-A contact between terminal 91 and 34 opens disabling the Automatic Start contact.

- 2) The H-O-A contact between terminals 22 (- V unreg.) and 78 (Hand-Auto) located on an options card opens causing the output frequency to respond to the manual speed potentiometer.
- 3) The H-O-A contact between terminals 89 and 34 closes, energizing the Run Command Relay (RCR) coil. If the H-O-A switch is rapidly moved from Auto to Hand, the RCR will momentarily drop out but will immediately pick up and the controller will continue to operate but with the speed controlled by the manual speed potentiometer.

B. Energizing RCR causes the following:

- 1) The RCR N.C. contact between terminal 38 and the Shutdown Enable input opens removing the negative voltage (- V unreg.) from the Shutdown Enable input causing the controller to switch from the shutdown mode.
- 2) The RCR N.O. contact between terminal 38 and the Drive Run Relay (DRR) N.O. closes preparing to enable the controller when the DRR N.O. contact closes.
- 3) The RCR N.O. contact between terminals 37 and 39 closes to energize the Isolation Contactor (IC) (refer to diagram 11.3.17).
- 4) The RCR N.O. contact between terminals 44 and 41 closes preparing to energize the Drive Run Relay (DRR), and Auxiliary Sequence Relay No. 2 (ASR2), when the isolation contactor (IC) N.O. contact closes. This contact also energizes the Sequence Timing Relay (STR) through the IC N.C. contact between terminals 41 and 86.

C. Energizing the Isolation Contactor (IC) shown on 11.3.17 causes the following:

- 1) The IC N.O. contact between terminal 41 and 42 closes energizing the Drive Run Relay (DRR) and Auxiliary Sequence Relay No. 2 (ASR2).
- 2) The IC N.C. contact between terminals 41 and 86 opens to disable STR. This must take place before STR times out to prevent Incomplete Sequence Shutdown of the controller.

- D. Energizing the DRR causes the following:
- 1) The DRR N.O. contact between RCR N.O. and Drive Enable input closes applying -V unreg. to the enable input to place the electronics in the run mode.
 - 2) The DRR N.O. contact between terminal 44 and the DRR coil closes to seal around RCR.
- E. The controller should now be operating with the output frequency controlled by the Manual Speed Potentiometer.
- F. Energizing ASR2 provides a form C contact in addition to the one provided by the DRR which can be used for external control or annunciation.
- G. If the Isolation Contactor does not pick up before STR times out, Auxiliary Sequence Relay No. 1 (ASR1) will be energized causing the following:
- H. Energizing ASR1 will cause the following:
- 1) The ASR1 N.O. contact in parallel with the Drive Fail Relay (DFR) coil will close causing DFR to drop out.
 - 2) The ASR1 N.O. contact between terminal 87 and the STR coil closes to seal in STR and ASR1 until the H-O-A switch is moved to the Off position.
 - 3) The ASR1 N.O. contact between J1-23 and terminal 85 will close illuminating the Incomplete Sequence pilot light (if used). Refer to wiring diagram 11.2.6.
- I. Dropping out the Drive Fail Relay (DFR) will cause the following:
- 1) The DFR N.C. Contact in parallel with the RCR coil will close causing RCR to drop out.
 - 2) DFR N.C. contact in parallel with the ASR2 coil will close causing ASR2 and DRR to drop out. This along with the RCR drop out from Step 1 will shutdown the controller.
 - 3) The DFR N.C. contact between terminals 105 and 106 will close to illuminate the Drive Fail pilot light (if used). Refer to wiring diagram 11.2.6.

Normal Stopping Sequence

- A. Moving the H-O-A selector switch to the OFF position deenergizes the RCR causing the following:
- 1) The RCR N.O. contact between terminal 38 and the DRR N.O. opens to take the electronics out of the run mode.
 - 2) The RCR N.C. contact between terminal 38 and the Shutdown Enable input closes causing the controller to switch to the shutdown mode and begin ramping the output frequency to minimum.
 - 3) The RCR N.O. contact between terminals 44 and 41 opens, removing the pick-up circuit from the DRR. Note DRR does not drop out due to the seal in contact. This contact also deenergizes the STR circuit causing STR to reset.
 - 4) The RCR N.O. contact between terminal 37 and 39 opens but the Isolation Contactor does not drop out because the DRR N.O. contact between terminals 45 and 46 remains closed. Refer to drawing.
- B. When the deceleration ramp has returned the output frequency to minimum, the electronic circuitry will pulse the silicon controlled rectifier (SCR) in parallel with the DRR coil to drop out the DRR and ASR2, thereby stopping the controller.
- C. Dropping out DRR also causes IC to be deenergized.

Abnormal Stopping Sequence

- A. Operation of a protective circuit will cause immediate controller shutdown upon occurrence of a fault condition. The electronic circuitry will trigger the SCRs in parallel with the RCR, DRR and DFR coils and keep them triggered until the controller is reset.
- B. The RCR, DRR, ASR2 and DFR relays will drop out returning all contacts to their deenergized state.
- C. The controller will stop immediately and the motor will coast to a stop.
- D. The DFR N.C. contact in parallel with the RCR coil will close keeping RCR dropped out.

- E. An additional DFR N.C. contact will close illuminating the Drive Fail pilot light (if used). Refer to wiring diagram 11.2.6.

Auto Mode

- A. Placing the Hand-Off-Auto (H-O-A) selector switch in the Auto mode causes the following:

- 1) The H-O-A contact between terminals 91 and 34 closes to enable the controller to start when the automatic start contact closes.
- 2) The H-O-A contact between terminals 89 and 34 opens preventing the controller from being manually started.
- 3) The H-O-A contact between terminals 22 (-V unreg.) and 78 (Hand/Auto) located on an option board closes causing the output frequency to respond to an analog input follower signal.

- B. Closing the automatic start contact energizes the Run Command Relay (RCR) causing the following:

- 1) The RCR N.C. contact between terminal 38 and the Shutdown Enable input opens removing the negative voltage (-V unreg.) from the Shutdown Enable input causing the controller to switch from the shutdown mode.
- 2) The RCR N.O. contact between terminals 38 and the Drive Run Relay (DRR) N.O. closes preparing to enable the controller when the DRR N.O. contact closes.
- 3) The RCR N.O. contact between terminals 37 and 39 closes to energize the Isolation Contactor (IC). See diagram 11.3.17.
- 4) The RCR N.O. contact between terminals 44 and 41 closes preparing to energize the Drive Run Relay (DRR), Auxiliary Sequence Relay No. 2 (ASR2), and Sequence Timer (STR) through IC N.C. between terminals 41 and 86.

- C. Energizing the Isolation Contactor (IC) shown on causes the following:

- 1) The IC N.O. contact between terminal 41 and 42 closes energizing

the Drive Run Relay (DRR) and Auxiliary Sequence Relay No. 2 (ASR2).

- 2) The IC N.C. contact between terminals 41 and 86 opens to disable STR. This must take place before STR times out to prevent Incomplete Sequence Shutdown of the controller.

- D. Energizing the DRR causes the following:

- 1) The DRR N.O. contact between RCR N.O. and the Drive Enable input closes applying -V unreg. to the enable input to place the electronics in the run mode.
- 2) The DRR N.O. contact between terminal 44 and the DRR coil closes to seal around RCR.

- E. The controller should now be operating with the output frequency controlled by the analog input signal.

- F. Energizing ASR2 provides a form C contact in addition to the one provided by the DRR which can be used for external control or annunciation.

- G. If the Isolation Contactor does not pick up before STR times out, Auxiliary Sequence Relay No. 1 (ASR1) will be energized causing the following:

- H. Energizing ASR1 will cause the following:

- 1) The ASR1 N.O. contact in parallel with the Drive Fail Relay (DFR) coil will close causing DFR to drop out.
- 2) The ASR1 N.O. contact between terminal 87 and the STR coil closes to seal in STR and ASR1 until the H-O-A switch is moved to the Off position or until the automatic start contact opens.
- 3) The ASR1 N.O. contact between J1-23 and terminal 85 will close illuminating the Incomplete Sequence pilot light if used. Refer to diagram 11.2.6.

- I. Dropping out the Drive Fail Relay (DFR) will cause the following:

- 1) The DFR N.C. Contact in parallel with the RCR coil will close causing RCR to drop out.

- 2) The DFR N.C. contact in parallel with the ASR2 coil will close causing ASR2 and DRR to drop out. This along with the RCR drop out from Step 1 will shutdown the controller.
- 3) The DFR N.C. contact between terminals 105 and 106 will close to illuminate the Drive Fail pilot light (if used). Refer to diagram 11.2.6.

Normal Stopping Sequence

- A. Opening the automatic start contact deenergizes the RCR causing the following:
 - 1) The RCR N.O. contact between terminal 38 and the DRR N.O. opens to take the electronics out of the run mode.
 - 2) The RCR N.C. contact between terminal 38 and the SHUTDOWN ENABLE input closes causing the controller to switch to the shutdown mode and begin ramping the output frequency to minimum.
 - 3) The RCR N.O. contact between terminals 44 and 41 opens, removing the pick-up circuit from the DRR. Note DRR does not drop out due to the seal in contact. This contact also deenergizes the STR circuit causing STR to reset.
 - 4) The RCR N.C. contact between terminal 37 and 39 opens but the Isolation Contactor does not drop out because the DRR N.O. contact between terminals 45 and 46 remains closed. Refer to drawing.
- B. When the deceleration ramp has brought the output frequency to minimum, the electronic circuitry will pulse the silicon controlled rectifier (SCR) in parallel with the DRR coil to drop out the DRR and ASR2, thereby stopping the controller.
- C. Dropping out DRR also causes IC to be deenergized.

Abnormal Stopping Sequence

- A. Operation of a protective circuit will cause immediate controller shutdown upon occurrence of a fault condition. The electronic circuitry will trigger the SCRs in parallel with the RCR, DRR and DFR coils and keep them triggered until the controller is reset.

- B. The RCR, DRR, ASR2 and DFR relays will drop out returning all contacts to their deenergized state.
- C. The controller will stop immediately and the motor will coast to a stop.
- D. The DFR N.C. contact in parallel with the RCR coil will close keeping RCR dropped out.
- E. An additional DFR N.C. contact will close illuminating the Drive Fail pilot light (if used). Refer to wiring diagram 11.2.6.

Operation With Isolation/Bypass Contactors

(Diagrams 11.2.5 and 11.3.6). Note: AFC-Off-Line switch used - jumper between terminals 22 and 3 removed.

AFC (Adjustable Frequency Controller) Mode

- A. Placing the AFC-Off-Line selector switch in the AFC position causes the following:
 - 1) The AFC-Off-Line contact between terminals 22 (- V unreg.) and 3 (Fast Stop) closes taking the controller out of the stop mode and permitting normal operation.
 - 2) The AFC-Off-Line contact on diagram or opens preventing the Bypass contactor from being energized.
- B. The controller operation is now as described for the Isolation Contactor.

Bypass Mode

- A. Placing the AFC-Off-Line selector switch in the Line position causes the following:
 - 1) The AFC-Off-Line contact between terminals 22 (- V unreg.) and 3 (Fast Stop) opens to place the controller in the stop mode.
 - 2) The AFC-Off-Line contact on diagram or closes to energize the Bypass Contactor (BC).
- B. The motor line starts and is now operating at constant speed from ac line voltage and frequency and will continue to operate independent of the adjustable frequency controller.

10.0 TROUBLESHOOTING & MAINTENANCE GUIDE**CONTENTS****10.0.1 MAINTENANCE****10.0.2 TROUBLESHOOTING, GENERAL COMMENTS****10.1 GENERAL SYMPTOMS**

- *1. Will not start
- *2. Will not accelerate load
- *3. Accelerates load too slowly
- 4. Decelerates too slowly
- 5. Excessive motor temperature

10.2 LED ANNUNCIATED FAULTS

- *1. Shoot through (ST) — IL5
- *2. Instantaneous Overcurrent (IOC) — IL7
- *3. Overvoltage (OV) — IL4
- *4. Ground Fault (GF) — IL6
- *5. Option Fault (OF) — IL10
- *6. Overload (OLD) — IL8
- 7. Overtemperature (OT) — IL9

10.3 MISCELLANEOUS

- 1. Undervoltage (UV) — IL3
- *2. Dynamic braking module

10.4 TROUBLESHOOTING PROCEDURES

- *1. Gating
- 2. Voltage output
- *3. Control power supply
- 4. Voltage balance
- 5. Shorted inverter GTO
- 6. Voltage feedback
- 7. Bus capacitor

10.5 TROUBLESHOOTING DATA

*** Designates Troubleshooting Flow Charts — located at end of Section 10.**

10.0.1 MAINTENANCE

During normal use, the drive controller will require minimum maintenance. However, good maintenance practice requires periodic inspection of the controller. The maintenance periods should be scheduled based on the particular operating environment of the controller, but should not exceed one year.

CAUTION

ONLY AUTHORIZED SERVICE PERSONNEL FAMILIAR WITH THIS EQUIPMENT SHOULD BE ALLOWED TO SERVICE THE CONTROLLER.

General maintenance procedures for Square D control gear are covered in Square D publication 30072-200-50. Procedures specific to this controller are as follows.

1. Standby lamp status should be verified per Section 7.6.
2. Drive controller operation should be observed. Any deviations from normal operation may be an indication of a controller malfunction. A thorough investigation should be made to determine the cause.
3. Check operation of any push-to-test pilot lamps.
4. Remove all power

DANGER

HAZARD OF ELECTRICAL SHOCK OR BURN

BEFORE SERVICING, TURN OFF POWER SUPPLY(S) TO THIS EQUIPMENT. WAIT 5 MINUTES. MEASURE CAPACITOR VOLTAGES TO VERIFY THAT THEY ARE ZERO. DO NOT SHORT ACROSS CAPACITORS WITH VOLTAGE PRESENT.

5. Tilt-out the power semiconductor assembly following the procedure found in this Section.
6. Inspect and clean all air passageways in controller using a vacuum cleaner. *Do not* use a compressed air source.
7. Inspect and clean all insulation systems within the controller using a vacuum cleaner. *Do not* use a compressed air source. *Do not "megger" controller!*
8. Check integrity of all mechanical fasteners.
9. Check integrity of all electrical fasteners and joints.
10. Check controller grounding means.
11. Check capacitor bank for damaged or bulging cans. Replace as required.
12. Inspect all electrical components for damage.
13. Reclose power semiconductor assembly following the procedure found in this Section.

DANGER

HAZARD OF ELECTRICAL SHOCK OR BURN

DO NOT ENERGIZE OR ATTEMPT TO OPERATE THE CONTROLLER WITH THE SEMICONDUCTOR ASSEMBLY IN THE SERVICE POSITION. ALL HEATSINK ASSEMBLIES ARE ELECTRICALLY HOT WHEN THE CONTROLLER IS ENERGIZED AND WHILE THE DC BUS CAPACITORS ARE CHARGED.

During normal maintenance or in the event that troubleshooting indicates possible power semiconductor failure (inverter GTO's or rectifier diodes) the power semiconductor assembly can be tilted out into the service position as shown in Section 4, Controller Photos. The following procedure *must* be followed to safely accomplish this task.

1. Remove all power**DANGER****HAZARD OF ELECTRICAL SHOCK OR BURN**

BEFORE SERVICING, TURN OFF POWER SUPPLY(S) TO THIS EQUIPMENT. WAIT 5 MINUTES. MEASURE CAPACITOR VOLTAGES TO VERIFY THAT THEY ARE ZERO. DO NOT SHORT ACROSS CAPACITORS WITH VOLTAGE PRESENT.

2. Verify that the controller is securely attached to its mounting surface.
3. If optional dynamic braking is not installed, remove the metal plate at the top right portion of the power semiconductor assembly. Refer to Section 4, controller photos for the location of the plate. If optional dynamic braking is installed it will take the place of the metal plate and must be removed.
4. Disconnect motor leads from the controller terminals.
5. Grasp the handle near the top of the power semiconductor assembly and carefully pull. The semiconductor assembly is hinged at the bottom and will tilt out approximately 90 degrees. A retaining cable will hold the assembly in the service position.
6. Lower the semiconductor assembly into the service position and insure that the retaining cable is securely attached.

DANGER**HAZARD OF ELECTRICAL SHOCK OR BURN**

DO NOT ENERGIZE OR ATTEMPT TO OPERATE THE CONTROLLER WITH THE SEMICONDUCTOR ASSEMBLY IN THE SERVICE POSITION. ALL HEATSINK ASSEMBLIES ARE ELECTRICALLY HOT WHEN THE CONTROLLER IS ENERGIZED AND WHILE THE DC BUS CAPACITORS ARE CHARGED.

7. Reverse the above procedure to return the controller to operating condition. Observe the retaining cable during the closing process to insure that it does not snag on any components or interfere with complete closing of the power semiconductor assembly.

CAUTION

CONSULT YOUR LOCAL SQUARE D REPRESENTATIVE BEFORE ATTEMPTING ANY MAINTENANCE ON THE POWER SEMICONDUCTOR ASSEMBLY.

10.0.2 TROUBLESHOOTING, GENERAL

A number of diagnostic and status indicating lights (refer to Section 7.0, Diagnostic Indicating LED's and Neon Light) have been included on the Main Control Board, Power Interface Board, Gate driver Boards, Option Boards, and Optional Dynamic Braking module. The intent of these lights is to provide visual indication of a number of controller operating and protective circuit functions to assist in maintenance and troubleshooting.

The following troubleshooting guide can best be utilized by observing the status of the lights and reviewing the symptoms listed to determine which possible problems could cause the observed light pattern. To view the lights, the controller door must be open with power applied to the controller. If the controller trips while operating, the lights must be viewed before power is removed because removing and re-applying power resets the fault indicators.

CAUTION

ONLY AUTHORIZED SERVICE PERSONNEL FAMILIAR WITH THIS EQUIPMENT SHOULD BE ALLOWED TO SERVICE THE CONTROLLER.

DANGER**HAZARD OF ELECTRICAL SHOCK OR BURN**

MANY PARTS INCLUDING ELECTRONIC PRINTED WIRE BOARDS IN THIS CONTROLLER OPERATE AT LINE VOLTAGE. DO NOT TOUCH. USE ONLY ELECTRICALLY INSULATED TOOLS WHILE MAKING ADJUSTMENTS.

DANGER**HAZARD OF ELECTRICAL SHOCK OR BURN**

CERTAIN ADJUSTMENTS AND TEST PROCEDURES REQUIRE THAT POWER BE APPLIED TO THIS CONTROLLER. WHEN WORKING WITH ENERGIZED EQUIPMENT, EXTREME CAUTION MUST BE EXERCISED AS HAZARDOUS VOLTAGES EXIST. THE ENCLOSURE DOOR MUST BE CLOSED AND SECURED WHILE TURNING ON POWER, OR STARTING AND STOPPING THIS CONTROLLER.

When used in conjunction with the diagnostic and status indicating lights this guide facilitates troubleshooting to the individual printed wiring board level.

The troubleshooting procedure is organized into 4 basic units. The first unit (10.1) covers general problems which are identified by a basic description (e.g. — "Controller will not start"). The second section (10.2) consists of specific faults annunciated by LED illuminations (e.g. — "Instantaneous Overcurrent (IL7)"). The third section (10.3) attempts to include those items not covered in 1 or 2 such as the dynamic braking module or LED illuminations which contain useful problem-solving information but are not fault indicators. The fourth and last section (10.4) is comprised of troubleshooting techniques which support the first 3 sections.

If troubleshooting indicates the necessity of component replacement, observe all precautions.

DANGER**HAZARD OF ELECTRICAL SHOCK OR BURN**

BEFORE SERVICING, TURN OFF POWER SUPPLY(S) TO THIS EQUIPMENT. WAIT 5 MINUTES. MEASURE CAPACITOR VOLTAGES TO VERIFY THAT THEY ARE ZERO. DO NOT SHORT ACROSS CAPACITORS WITH VOLTAGE PRESENT.

When contacting Square D for troubleshooting assistance or requesting service, it is necessary to have the information requested on the controller trouble sheet available. If the controller is to be returned to Square D, a completed copy of the sheet must be inserted in the controller before packing for shipment. Several copies of the controller trouble sheet are provided at the end of the troubleshooting section.

10.1.4 MOTOR DECELERATES TOO SLOWLY

Depending on load inertia, the ramp modification circuit may be automatically extending the deceleration rate. To verify that controller ramp circuits are functioning properly and that the ramp modification circuit is extending the deceleration rate perform the following:

1. **Remove all power.**
2. Disconnect motor leads from terminals T1, T2, and T3. Read and observe caution notes concerning controller servicing.
3. While measuring the voltage between terminals TB1-4(+) and TB1-6 (common) start the controller and monitor the voltage change. This DC voltage is a signal proportional to drive output frequency with a scaling factor of 2.5 VDC = Base Frequency (F_{BASE}). Compare the time required for this voltage to fall from 2.5 VDC to OVDC with the desired deceleration time as determined by

Main Control Board selector switch SW5 and potentiometer P10 (Dec) (refer to Section 6.0 to verify these settings). This step confirms the deceleration circuitry is operable. If the deceleration rate cannot be controlled by P10 and SW5 (per 6.0) replace the Main Control Board.

4. Remove all power. Read and observe caution notes concerning controller servicing.

5. With the open-circuit ramp operation verified and with all power removed, connect the motor leads and perform the voltage check described in (2). Read and observe caution notes concerning controller servicing. If the time required to decelerate with load attached is greater than the time required to decelerate with the load disconnected, the ramp modification circuit is being activated. If a faster deceleration time is required, reduce the load inertia or install dynamic braking or regenerative braking options.

10.1.5 EXCESSIVE MOTOR TEMPERATURE

Motor Overheating can result from the following items:

1. Motor incorrectly sized for load. Measure motor current and compare to nameplate rating.
2. Since most motors are cooled by internal shaft-mounted fans, the motor rated current capacity will decrease with speed due to decreased fan speed. If substantial motor torque is required at low speed, motor overtemperature may occur. The motor manufacturer should be consulted to determine the correct motor selection for such applications.
3. Verify that voltage output is correct per 10.4.2.

NOTE: With the advent of modern insulation materials, many motors are capable of operating at relatively high winding temperatures. Therefore, motors which seem hot-to-the-touch may be operating well within their temperature limits. The motor nameplate should be consulted as to the class of the motor's insulation system. To properly determine a motor's temperature, the procedures described in NEMA MG-1 may be followed.

10.2.7 OVERTEMPERATURE (OT) LED (IL9)

The overtemperature (OT) LED (IL9) will illuminate whenever the normally closed switch, as shown on the control elementary diagram (refer to the table of contents under Section 11 to determine the drawing number) connected between terminals TB1-28 and TB1-22 through tie-point TB1-18 is opened. In this event the following items should be checked:

1. Excessive ambient temperature per Section 3.1.4.
2. Controller cooling fan failure (location per Section 4).
3. Loose or defective electrical connection.
4. Check for tripped motor thermal switch if the motor is so equipped. Refer to Section 10.1.5, excessive motor temperature.
5. Defective precharge relay or precharge contactor.
6. Dirty heatsink assembly or blocked air flow. See Section 10.0.1.

10.3.1 UNDERVOLTAGE (UV) LED IL3

The undervoltage LED is illuminated whenever the controller input line voltage falls below 87.5% of rated line voltage (per Section 3.1.1). There is hysteresis in this circuitry so that voltage must rise back to a level of 95% rated voltage before the undervoltage condition is removed. While in a UV condition the precharge relay is de-energized and the drive is inhibited from running. In the event of an undervoltage condition consider the following items:

1. Low AC input per specifications of Section 3.1.1.
2. Momentary AC line dip — controller will automatically reset and run if 2-wire control is used. Three-wire control circuits will require that the start button be depressed.
3. Verify that frequency selection snip-out resistors on the Main Control Board and control transformer jumpers are set properly per Section 6.0.
4. Refer to 10.4.3 and perform a control power supply check.

10.4.2 VOLTAGE OUTPUT

Improper voltage output may cause Overload, Instantaneous Over Current, or insufficient torque. Perform the following to verify that the voltage output is correct.

1. Perform the voltage balance procedure per 10.4.4. If no imbalance is found, continue to the next step.
2. Remove all power. Read and observe caution notes concerning controller servicing.
3. With the motor leads disconnected from terminals T1, T2, and T3, adjust the input speed signal until the voltage between TB1-4(+) and TB1-6 (common) on the Main Control Board (refer to Figure 8.1) is 1.25 VDC.
4. With the controller at this frequency, measure the voltage between TB1-26(+) and TB1-6 (common). Compare this measured voltage (V) to the voltage listed in Table 1 for the switch configuration of the controller under examination. The measured voltage should be within ± 10% of the tabulated value.
5. If the conditions of (4) are not satisfied, confirm the integrity of the voltage feedback per 10.4.6.
6. If voltage feedback is functioning properly, replace the Main Control Board.

TABLE 1
Main Control Board Dip Switch Settings①

Controller Input Voltage	Motor Nameplate Voltage	SW1	SW2	SW3	SW4	SW5	SW6	SW7	SW8	V(± 5%)
200V	200V	X	X	X	*	*	O	O	*	.87V
230V	200V	X	X	X	*	*	O	O	*	.87V
230V	230V	X	X	O	*	*	O	O	*	1.00V
460V	200V	X	X	X	*	*	X	O	*	.87V
460V	230V	X	X	O	*	*	X	O	*	1.00V
460V	400V	O	X	O	*	*	X	X	*	1.74V
460V	460V	O	X	O	*	*	X	O	*	2.00V

X-Closed Switch (On)

O-Open Switch (Off)

* -Either position is acceptable

① Refer to Section 6, controller adjustments for additional information on the proper setting of the dip switches.

10.4.4 CONTROLLER OUTPUT VOLTAGE MEASUREMENT

Controller output voltage can indicate a potential gating problem. The following procedure illustrates this concept:

1. Remove all power. Read and observe caution notes concerning controller servicing.
2. With all power removed, remove motor leads from terminals T1, T2, and T3 so that controller output is open circuited. Read and observe caution notes concerning controller servicing.
3. Start the controller and adjust the output frequency to 60 HZ by varying input speed signal until the DC voltage between TB1-4(+) and TB1-6 (common) is 2.5VDC (see Section 8.1 for location of TB1). Note: if the controller is capable of hand or automatic operation, the hand mode should be used and speed should be varied with the manual speed potentiometer.
4. Measure the line to line output voltages from T1 to T2, T2 to T3, and T1 to T3 (see Section 4.0 for location). These voltages should be within 5% of each other. The actual voltage reading is not important. Because of the complex output waveform, different voltmeters may read different values. The major concern is that all three readings indicate balanced voltages. If not, this indicates a problem in a gating channel. The output which is common to the two lowest line-to-line readings is driven by the two suspect gating channels. As an example, suppose V(T1—T2) = 400V, V(T2—T3) = 500V, and V(T1—T3) = 400. Since T1 is common to V(T1—T2) and V(T1—T3), the two lowest readings, there is a problem in the gating circuitry or GTOs that drive that terminal.

To correct the problem, the following items should be replaced sequentially. Read and observe caution notes concerning controller servicing.

1. The pair of gate drivers associated with that output terminal (illustrated in Section 4).
2. Ribbon cable between the Main Control Board and Power Interface Board.
3. Main Control Board
4. Power Interface Board — be certain to use two known good Gate Drivers in the positions which drive the suspect terminal.

If Steps 1 - 4 above do not correct the problem, contact the factory.

10.4.5 SHORTED INVERTER GATE TURN-OFF THYRISTOR (GTO)

Remove all power from the controller. Read and observe caution notes concerning controller servicing. Disconnect the motor leads at terminals T1, T2 and T3. With an ohmmeter on the RX10 scale perform the measurements in Table 2. If a low resistance measurement is encountered where a high resistance measurement is expected, a shorted GTO is indicated. The terms high and low resistance are relative and comparison with the other measurements should clarify a questionable reading. Note: A shorted GTO could be the result of some other problem. Failure to determine the cause may result in failure of the replacement GTO. Contact your local Square D representative if a shorted GTO is suspected.

TABLE 2

Ohmmeter* + Lead	Ohmmeter* - Lead	Measurement (Resistance)
+ Bus	T1	High
+ Bus	T2	High
+ Bus	T3	High
T1	+ Bus	Low
T2	+ Bus	Low
T3	+ Bus	Low
- Bus	T1	Low
- Bus	T2	Low
- Bus	T3	Low
T1	- Bus	High
T2	- Bus	High
T3	- Bus	High

*Refer to Section 4, controller photos to determine the location of terminals.

10.4.6 VOLTAGE FEEDBACK

This procedure verifies the integrity of the controller output voltage sense resistors, both DC bus voltage and motor terminal voltages and the ribbon cable which conveys voltage feedback information from the Power Interface Board to the Main Control Board. Defective voltage feedback usually results in Instantaneous Over Current (IL7) or Shoot Through trips (IL5).

1. **Remove all power. Read and observe caution notes concerning controller servicing.**
2. With all power removed, disconnect the motor leads from terminals T1, T2 and T3. Refer to Section 4 for the location of T1, T2 and T3.
3. Remove the ribbon cable between the Main Control Board and the Power Interface Board.
4. Place one lead of an ohmmeter on test point TP3 of the Power Interface Board (PIB) and the other lead on terminal T1 (refer to Section 4 to determine the location). The meter should read 3 megohms. If not, replace the Power Interface Board.
5. Repeat Step 4 for test point TP4 and terminal T2.
6. Repeat Step 4 for test point TP5 and terminal T3.
7. Repeat Step 4 for test point TP1 and + bus terminal.
8. Repeat Step 4 for test point TP2 and - bus terminal.
9. Place the meter on the RX1 scale and check the continuity of the ribbon cable. Each conductor should read two ohms or less. If any are of a higher value, replace the ribbon cable.

10.4.7 BUS CAPACITOR

An open bus capacitor may result in overvoltage (OV) or shoot through (ST). A shorted bus capacitor will result in blown incoming line fuses. Capacitors which initially fail shorted, blowing the input line fuses, will generally open-circuit after the internal protective mechanism operates to clear the capacitor's internal short circuit. This condition can be visually detected by examining the top of the capacitor. The top of the capacitor will be bulged outward creating a dome shape. This failed capacitor and any blown input line fuses should be replaced and the possible loss of input lines to the controller should be investigated. If a failed capacitor is suspected, but is not visually detectable, a general indication of capacitor condition can be obtained with an analog ohmmeter. **Remove power from the controller. Read and observe caution notes concerning controller servicing.** With the meter scaling at RX1000 connect the meter leads across the capacitor terminals. A shorted capacitor will indicate low resistance, an open capacitor will indicate infinity, and a good capacitor will deflect momentarily and then return to the infinity position.

10.5 TROUBLESHOOTING DATA

PLACE THE TROUBLE SHEET WITH THE AUTHORIZED RETURN PAPER RECEIVED FROM YOUR LOCAL SQUARE D REPRESENTATIVE.

The purpose of the "Trouble Sheet" is to obtain as much pertinent information about the controller as possible. By fully filling out the following form the time to repair the controller and the cost of troubleshooting the controller are reduced. The following is an explanation of the type of information needed on this form.

USER NAME AND ADDRESS: Where the controller is installed

PERSON TO CONTACT: Someone at the user who is familiar with the problem and application. Contact for additional information may be required.

CONTROLLER DATA: Completely fill in the sample nameplate given on the bottom of the form.

MOTOR DATA: Fill in the requested information. If you have multiple motors give the information for all the motors controlled by the AFC.

APPLICATION DATA:

- Ambient temperature
- Type of load being controlled (i.e. conveyor, mixer, pump, fan, etc.)
- Basic power flow from supply to motor. Indicate if any contactors or circuit breakers are installed before the motor, or between the controller and motor. Is there any line bypass or across-the-line start capabilities?
- Is this a multiple motor scheme? Are the motors started all at the same time or sequenced?
- Type of speed control
Hand pot, analog input signal (4-20 ma, 0-10V dc, etc.) or pneumatic signal
- Braking options installed. If a regeneration controller is used refer to Service Bulletin 8804-2. Record status of D.B. LED's.
- If remote control wiring is installed detail the functions (start-stop, run-jog, etc.) and the terminals to which your wiring is connected.

PROBLEM INFORMATION:

Description of Symptoms:

- Does fault occur
 - When only power is on the controller
 - When start button is pushed
 - When changing speeds
 - When running at constant speed
 - When stopping
 - When motor load changes
- Does problem have a pattern (I.E. does problems occur at same time during day?) or is the problem random?
- Signs of visual damage (bulging capacitor cans, blown fuses, discoloration on boards)

CONTROLLER TROUBLE SHEET

DETAIL TROUBLESHOOTING STEPS TAKEN

In the service bulletins there are a number of troubleshooting steps to be taken. List the steps taken and the results of those steps. If you have done any troubleshooting on your system detail those steps and results also.

USER NAME _____

ADDRESS _____

CITY, STATE, ZIP _____



PERSON TO CONTACT _____

PHONE _____



PURCHASER (DISTRIBUTOR) _____ P.O. # (IF AVAILABLE) _____

CONTROLLER DATA: (FILL IN NAMEPLATE INFORMATION)

1500 CONTROLLER NAMEPLATE

	OMEGAPAK™		
	ADJUSTABLE FREQUENCY CONTROLLER		
	CLASS 8804	TYPE _____	SER _____
INPUT			
VOLTS	_____	_____	_____
MAX. WITHSTAND SYM. AMPS RMS _____			
MAX. AMPS	3PH _____	1PH _____	60HZ _____
OUTPUT		OVERLOAD CAP.	% FOR 1 MIN
H.P.	_____	_____	_____
VOLTS	0- _____	0- _____	0- _____
3-60/90/120HZ		3PH	S.F. 1.0
MAX. AMPS _____		O.L. SETTING REFER TO S.B. _____	
		87	_____
51140-291-01			

3500 CONTROLLER NAMEPLATE

	MOTOR CONTROLLER		
	CLASS 8804		
BUS RATING	BUS BAR BRACED FOR		
HORIZ	_____	_____	AMP RMS
VERT.	_____	SYM. AVAILABLE	
MAX		_____	
			
87			51139-262-01

MOTOR DATA:

HP _____ VOLTAGE _____ FULL LOAD CURRENT _____

SERVICE FACTOR _____ NEMA DESIGN _____ SPEED _____

APPLICATION DATA:

APPLICATION (DESCRIBE) _____

SPEED RANGE: MAX. SPEED _____ MIN. SPEED _____ DUTY CYCLE _____

CONTROLLER TROUBLE SHEET (continued)

PROBLEM INFORMATION:

LED'S THAT ARE ILLUMINATED (MARK ON DRAWING)

NO. OF GATE DRIVER LED'S ON _____

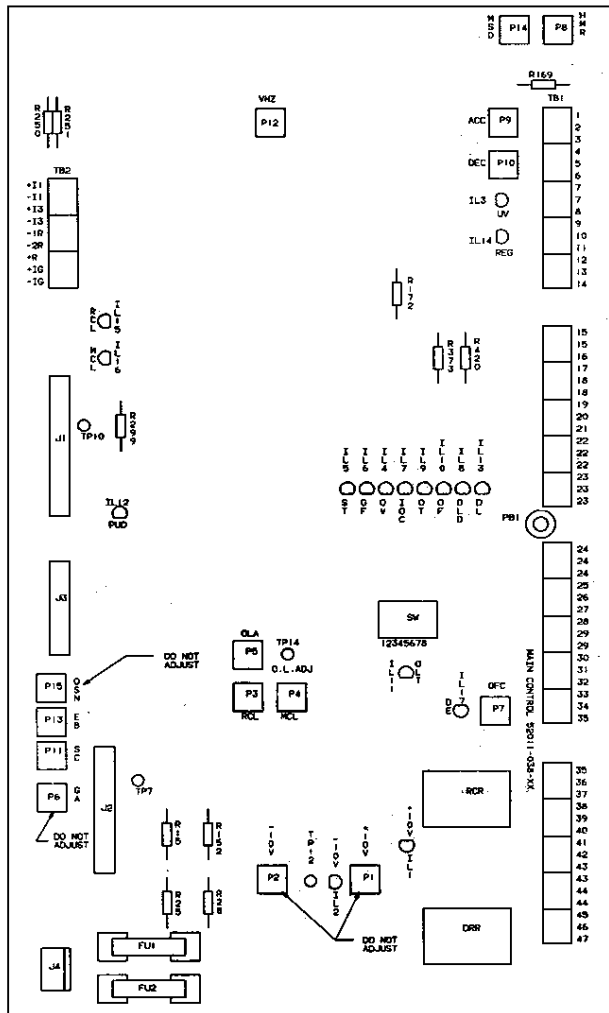

LENGTH OF TIME CONTROLLER HAS OPERATED PROPERLY:

_____ MONTHS, OR PROBLEM OCCURRED AT START-UP _____

DESCRIPTION OF SYMPTOMS _____

DETAIL TROUBLESHOOTING STEPS TAKEN _____

CONTROLLER TROUBLE SHEET

DETAIL TROUBLESHOOTING STEPS TAKEN

In the service bulletins there are a number of troubleshooting steps to be taken. List the steps taken and the results of those steps. If you have done any troubleshooting on your system detail those steps and results also.

USER NAME _____

ADDRESS _____

CITY, STATE, ZIP _____



PERSON TO CONTACT _____

PHONE _____



PURCHASER (DISTRIBUTOR) _____ PO. # (IF AVAILABLE) _____

CONTROLLER DATA: (FILL IN NAMEPLATE INFORMATION)

1500 CONTROLLER NAMEPLATE

	OMEGAPAK™		
	ADJUSTABLE FREQUENCY CONTROLLER		
	CLASS 8804	TYPE _____	SER _____
INPUT			
VOLTS	_____	_____	_____
MAX. WITHSTAND SYM. AMPS RMS			
MAX. AMPS	3PH _____	1PH _____	60HZ _____
OUTPUT		OVERLOAD CAP.	% FOR 1 MIN
H.P.	_____	_____	_____
VOLTS	0- _____	0- _____	0- _____
3-60/90/120HZ		3PH	S.F. 1.0
MAX. AMPS _____		O.L. SETTING REFER TO S.B. _____	
		87	_____
51140-291-01			

3500 CONTROLLER NAMEPLATE

	MOTOR CONTROLLER		
	CLASS 8804		
BUS RATING	_____	BUS BAR BRACED FOR	_____
HORIZ	_____	AMP RMS	_____
VERT.	_____	SYM. AVAILABLE	_____
○	_____	MAX	○
87			
			
51139-262-01			

MOTOR DATA:

HP _____ VOLTAGE _____ FULL LOAD CURRENT _____

SERVICE FACTOR _____ NEMA DESIGN _____ SPEED _____

APPLICATION DATA:

APPLICATION (DESCRIBE) _____

SPEED RANGE: MAX. SPEED _____ MIN. SPEED _____ DUTY CYCLE _____

CONTROLLER TROUBLE SHEET (continued)

PROBLEM INFORMATION:

LED'S THAT ARE ILLUMINATED (MARK ON DRAWING)

NO. OF GATE DRIVER LED'S ON _____

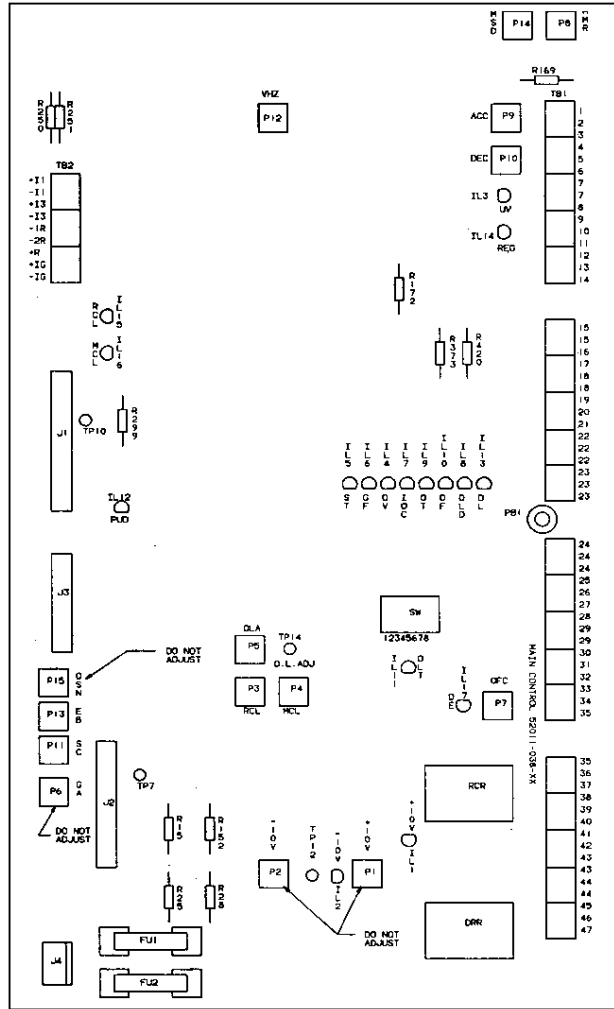

LENGTH OF TIME CONTROLLER HAS OPERATED PROPERLY:

_____ MONTHS, OR PROBLEM OCCURRED AT START-UP _____

DESCRIPTION OF SYMPTOMS _____

DETAIL TROUBLESHOOTING STEPS TAKEN _____

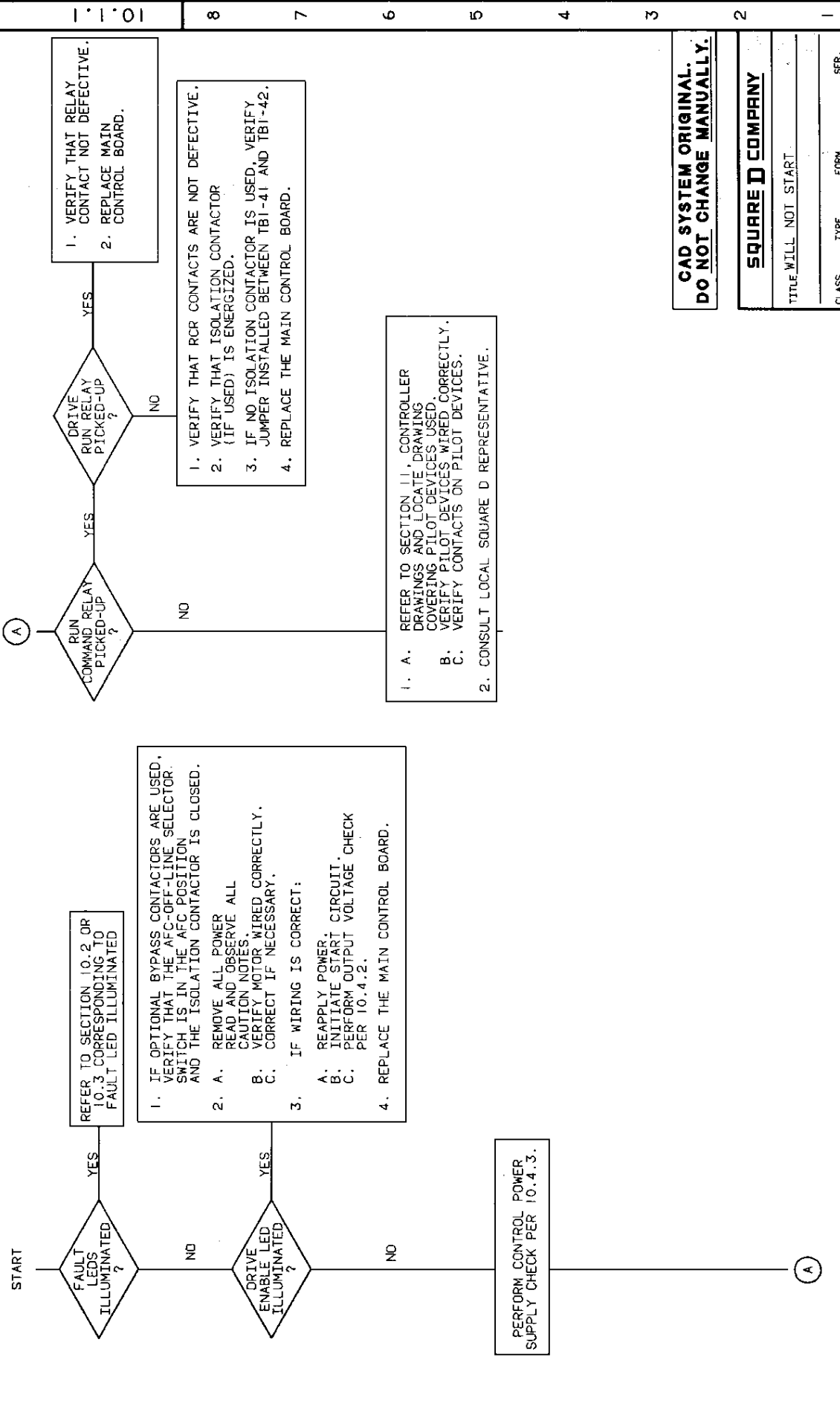

DATE CHG 2-86	DATE REL.	DRG. NO.	SER.
DRG.	APP'D	10.1.1	ORD FILE
REF. ASSEM	CLASS	TYPE	FORM
PROJ. NO.	TITLE WILL NOT START		
SQUARE D COMPANY			
CAD SYSTEM ORIGINAL. DO NOT CHANGE MANUALLY.			

REV.	DATE	BY	REVISION DESCRIPTION

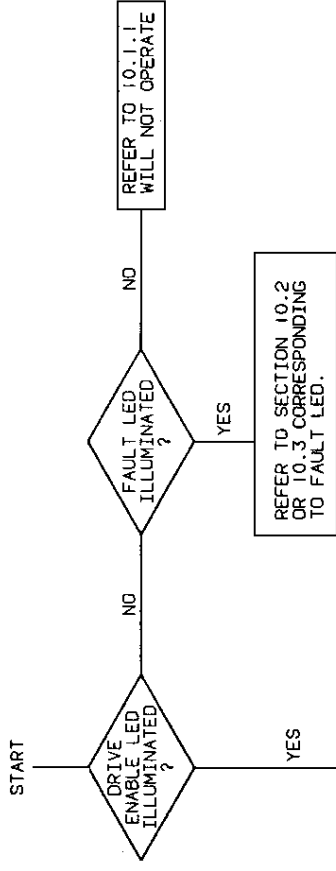

1. VERIFY MOTOR CURRENT LIMIT (MCL) POTENTIOMETER IS FULLY CLOCKWISE.
2. VERIFY THAT THE VOLTAGE BOOST (E-BOOST) POTENTIOMETER IS ADJUSTED CORRECTLY, PER SECTION 6.0.
3. CHECK FOR PROPER GATING PER 10.4.1.
4. PERFORM OUTPUT VOLTAGE CHECK PER 10.4.2.
5. VERIFY THAT THE LOAD IS MECHANICALLY FREE TO ROTATE.
6. VERIFY THAT THE STARTING TORQUE REQUIRED DOES NOT EXCEED THE MOTOR/CONTROLLER CAPABILITY.
7. CONSULT LOCAL SQUARE D REPRESENTATIVE.

**CAD SYSTEM ORIGINAL.
DO NOT CHANGE MANUALLY.**

SQUARE D COMPANY
TITLE WILL NOT ACCELERATE

CLASS TYPE FORM SER
DATE DES 2-86
DATE REL 1986 NO
CNO APP'D 10.1.2
REF. ASSEM PROJ. NO
REV. DATE REVISION DESCRIPTION BY

REV.	DATE	REVISION DESCRIPTION	BY	REF. ASSEM PROJ. NO	CNO	APP'D	DATE REL	DATE DES	FORM	SER	10.1.2	10.1.2	1
------	------	----------------------	----	---------------------	-----	-------	----------	----------	------	-----	--------	--------	---

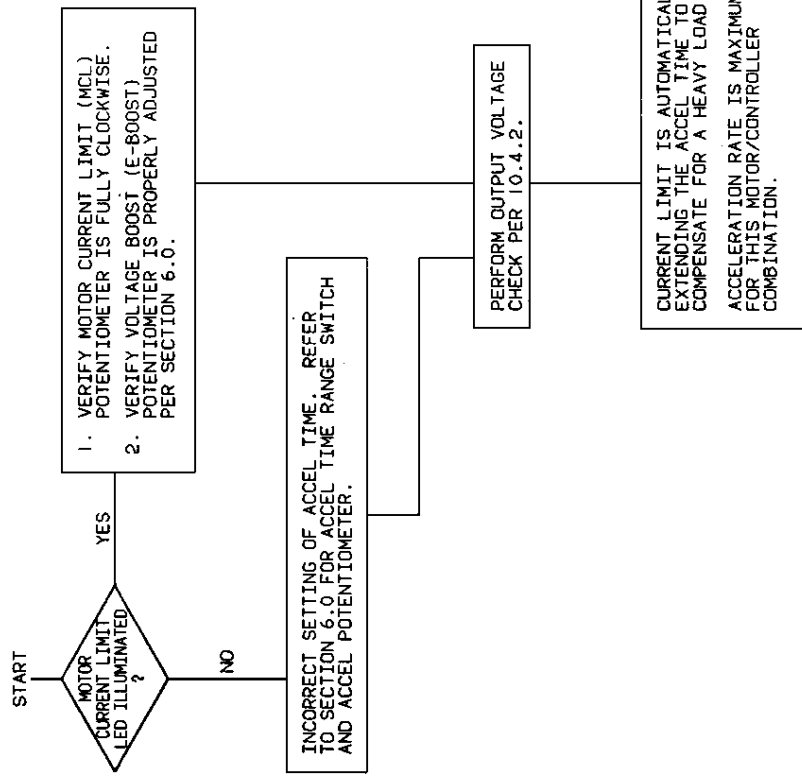

CAD SYSTEM ORIGINAL. DO NOT CHANGE MANUALLY.

SQUARE D COMPANY
TITLE ACCELERATES TOO SLOWLY
CLASS TYPE FORM SER.

DWG NO. 2-86
DATE 12-86
APP'D
SER. 10.1.3

REF. DESIG. PROJ. NO.
BY

REVISION DESCRIPTION

REV.	DATE	DESCRIPTION	BY

10.1.01

(A)

1. CHECK FOR OPEN DC BUS CAPACITOR PER 10.4.7.
 2. CHECK FOR LOSS OF PHASE ON INCOMING LINE.



1. NOISE INDUCED MISFIRING OF GTD, RESET AND RESTART CONTROLLER.
 2. GATING PROBLEMS, REFER TO 10.4.1.
 3. OPEN DC BUS CAPACITOR, CHECK PER 10.4.7.
 4. LOSS OF PHASE.
 5. DEFECTIVE OR POORLY TERMINATED GROUND RESISTOR BETWEEN TBI-20 AND TBI-21.
 6. IMPROPER SHIELD TERMINATION ON EXTERNAL CONNECTION.
 7. CONTROLLER NOT SOLIDLY GROUNDED REFER TO SECTION 2.4.
 8. DEFECTIVE DYNAMIC BRAKE UNIT (IF USED), CHECK PER 10.3.2.
 9. IMPROPER OPERATION OF OUTPUT CONTACTOR, REFER TO SECTION 2.2.3.
 10. UNSUPPRESSED INDUCTIVE LOAD(S) (BRAKE COILS, RELAY COILS, SOLENOIDS, ETC.) IN CLOSE PROXIMITY TO CONTROLLER.
 11. CONSULT LOCAL SQUARE D REPRESENTATIVE.

(B)

REPLACE THE MAIN CONTROL BOARD.



1. REPLACE THE GATE DRIVER BOARD.
 2. IF PROBLEM NOT SOLVED, REPLACE THE POWER INTERFACE BOARD AND THE GATE DRIVER BOARD WHICH HAD THE ILLUMINATED LED.
 3. CONSULT LOCAL SQUARE D REPRESENTATIVE.

**CAD SYSTEM ORIGINAL.
 DO NOT CHANGE MANUALLY.**

SQUARE D COMPANY

TITLE ST LED ILLUMINATES

CLASS _____ TYPE _____ FORM _____ SER _____
 DATE DESIGNED 2-85
 DATE REVISED _____
 DRAWN BY _____
 CHECKED BY _____
 PROJECT NO. _____
 DRG. NO. _____
 10.2.1
 CAD FILE 2
 2

REV.	DATE	BY	REVISION DESCRIPTION

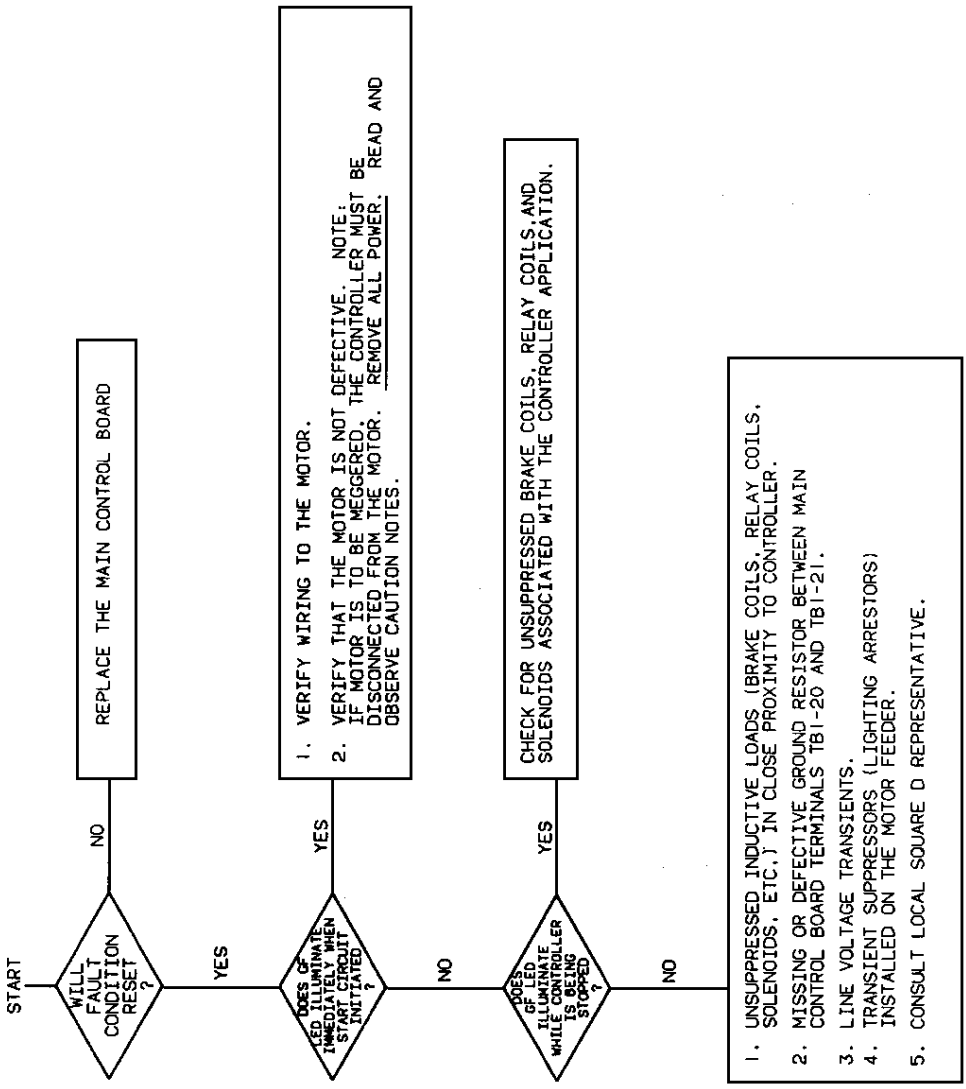

**CAD SYSTEM ORIGINAL.
DO NOT CHANGE MANUALLY.**

SQUARE D COMPANY

TITLE GF LED ILLUMINATES

CLASS _____ TYPE _____ FORM _____ SER. _____

DATE ORN: 2-86

DATE ORN: _____

ORN _____

CHD _____

APTD _____

ORJ _____

PRJ NO. _____

REF _____

TEST ASSEM _____

PROJ. NO. _____

DATE ORN: 2-86

ORN _____

CHD _____

APTD _____

ORJ _____

PRJ NO. _____

REF _____

TEST ASSEM _____

PROJ. NO. _____

DATE ORN: 2-86

ORN _____

CHD _____

APTD _____

ORJ _____

PRJ NO. _____

REF _____

TEST ASSEM _____

PROJ. NO. _____

REV. I	DATE	REVISION DESCRIPTION	BY

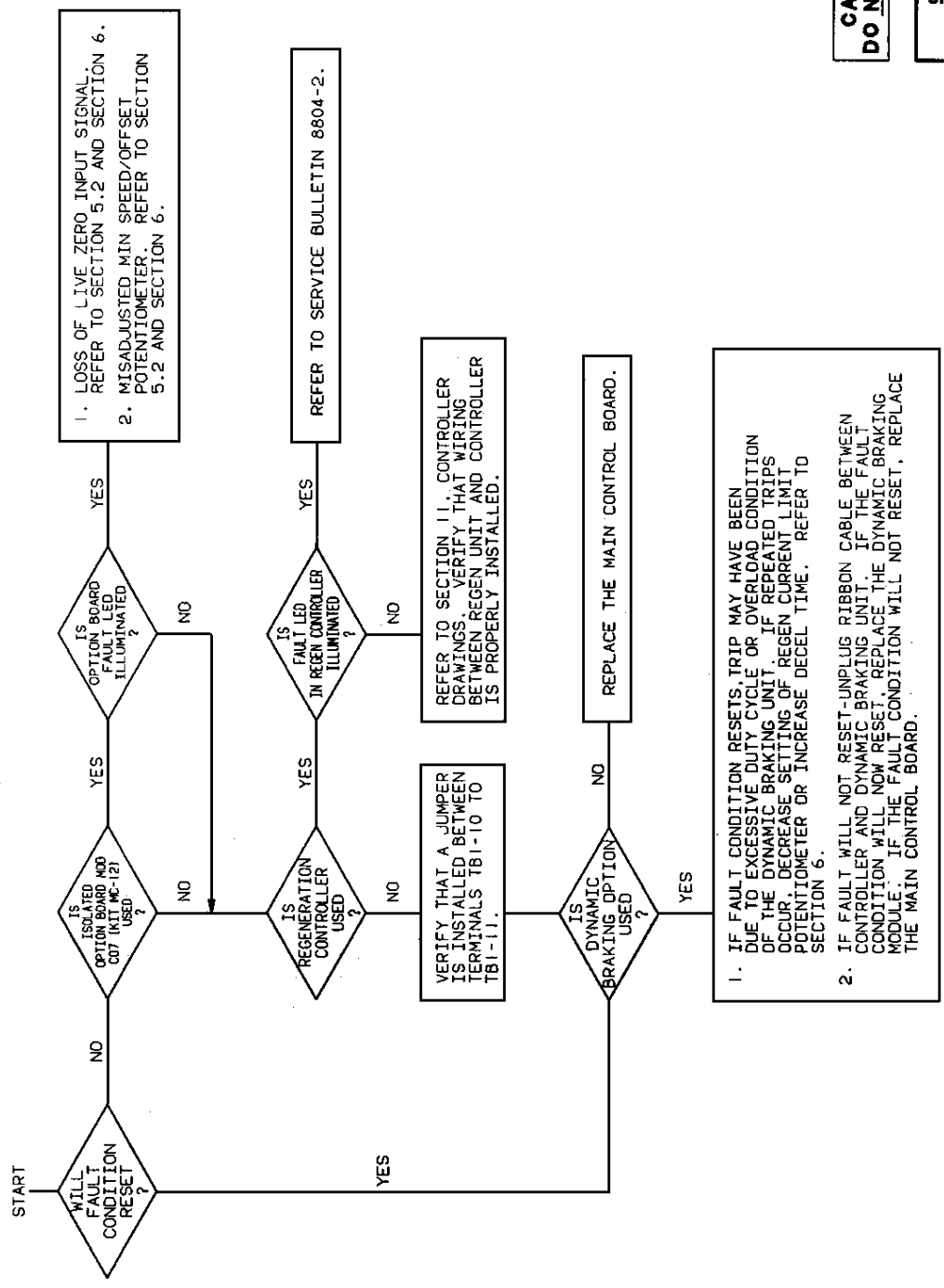

CAD SYSTEM ORIGINAL. DO NOT CHANGE MANUALLY.

SQUARE D COMPANY

TITLE OF (OPTION FAULT) LED ILLUMINATED

CLASS TYPE FORM SER. NO. 10.2.5
 DATE DRN 2-85
 DRN CD. APP'D
 REF. DESIG. PROJ. NO.

REV.	DATE	DESCRIPTION	BY

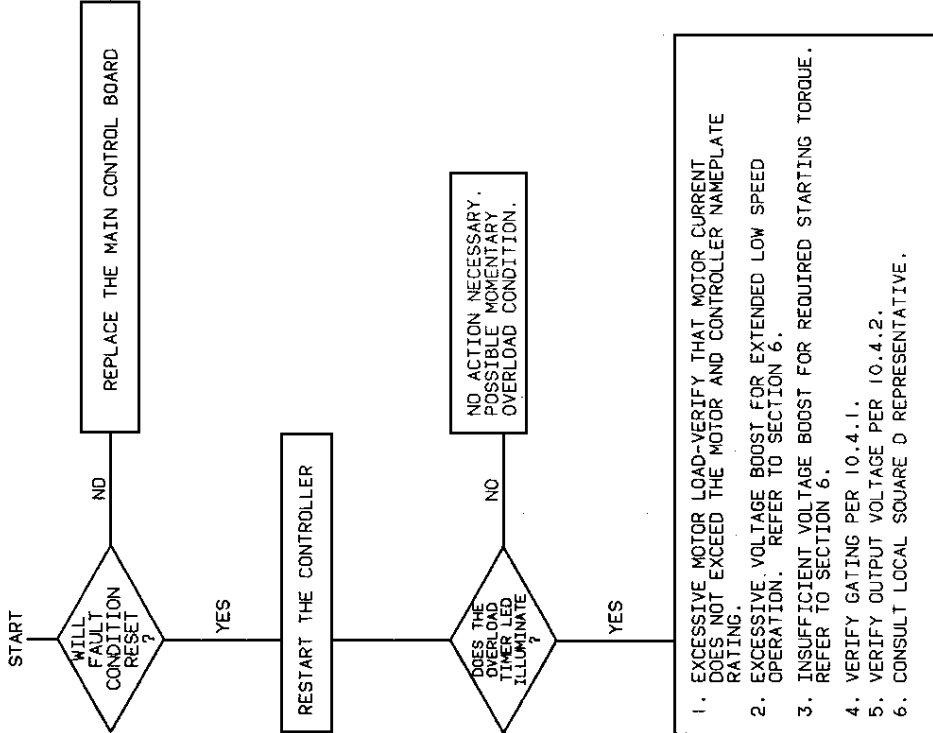

**CAD SYSTEM ORIGINAL.
DO NOT CHANGE MANUALLY.**

SQUARE D COMPANY

TITLE OLD LED ILLUMINATES

CLASS TYPE FORM SER. _____
 DATE REL. 10.2.6
 DATE DES. 2-86
 DRN. CNO. APP'D
 REF. ASSEM. PROJ. NO.
 REV. DATE REVISION DESCRIPTION BY

CAD FILE 10.2.6

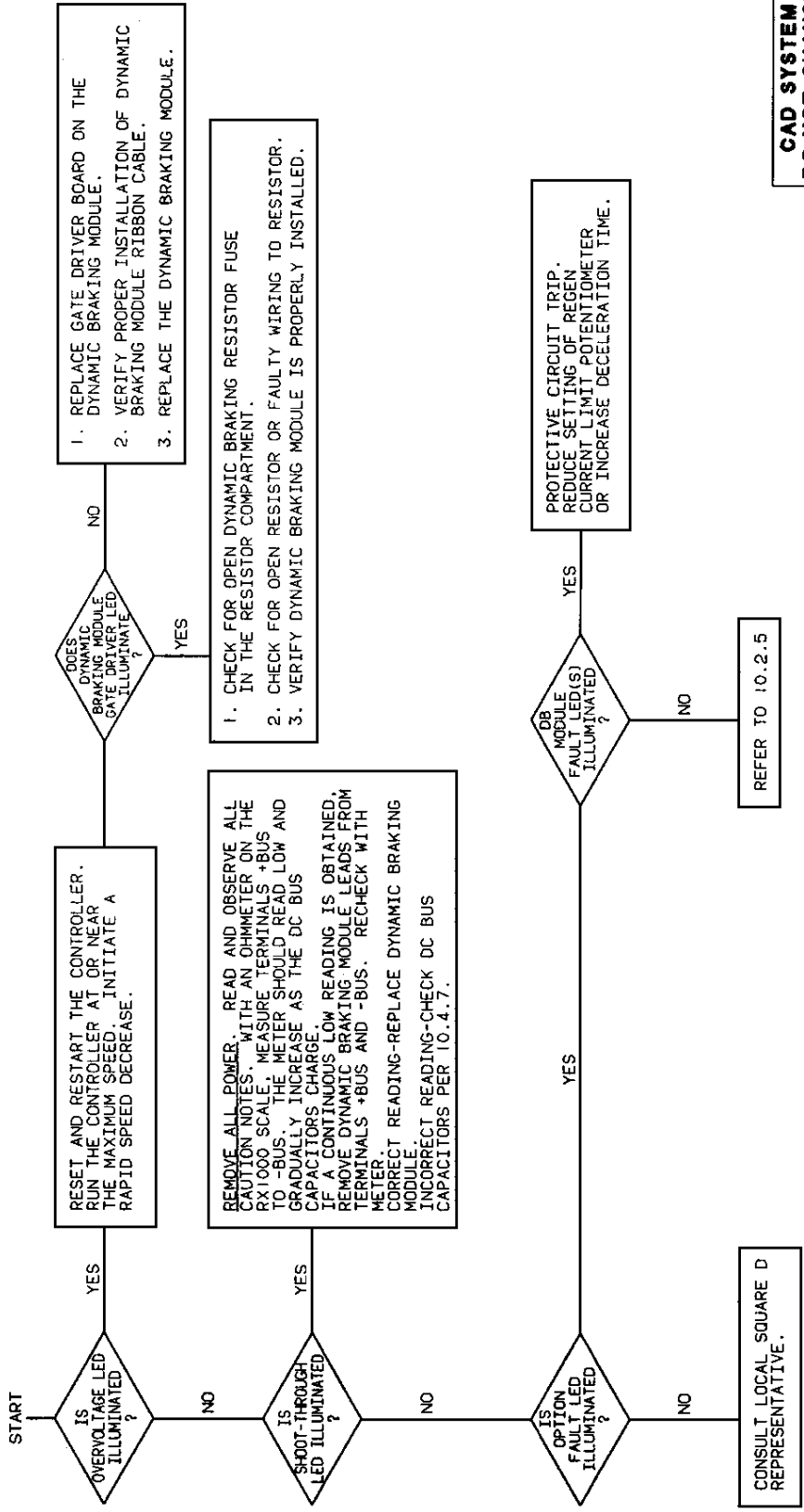

**CAD SYSTEM ORIGINAL.
DO NOT CHANGE MANUALLY.**

SQUARE D COMPANY
TITLE: DYNAMIC BRAKING MODULE
(IF USED)
CLASS: TYPE: FORM: SER:

DATE: 2-85
REF. ASSEM. PROD. NO.
DATE REC. 10.3.2
DRA. APP'D. DWT

REV.	DATE	REVISION DESCRIPTION	BY

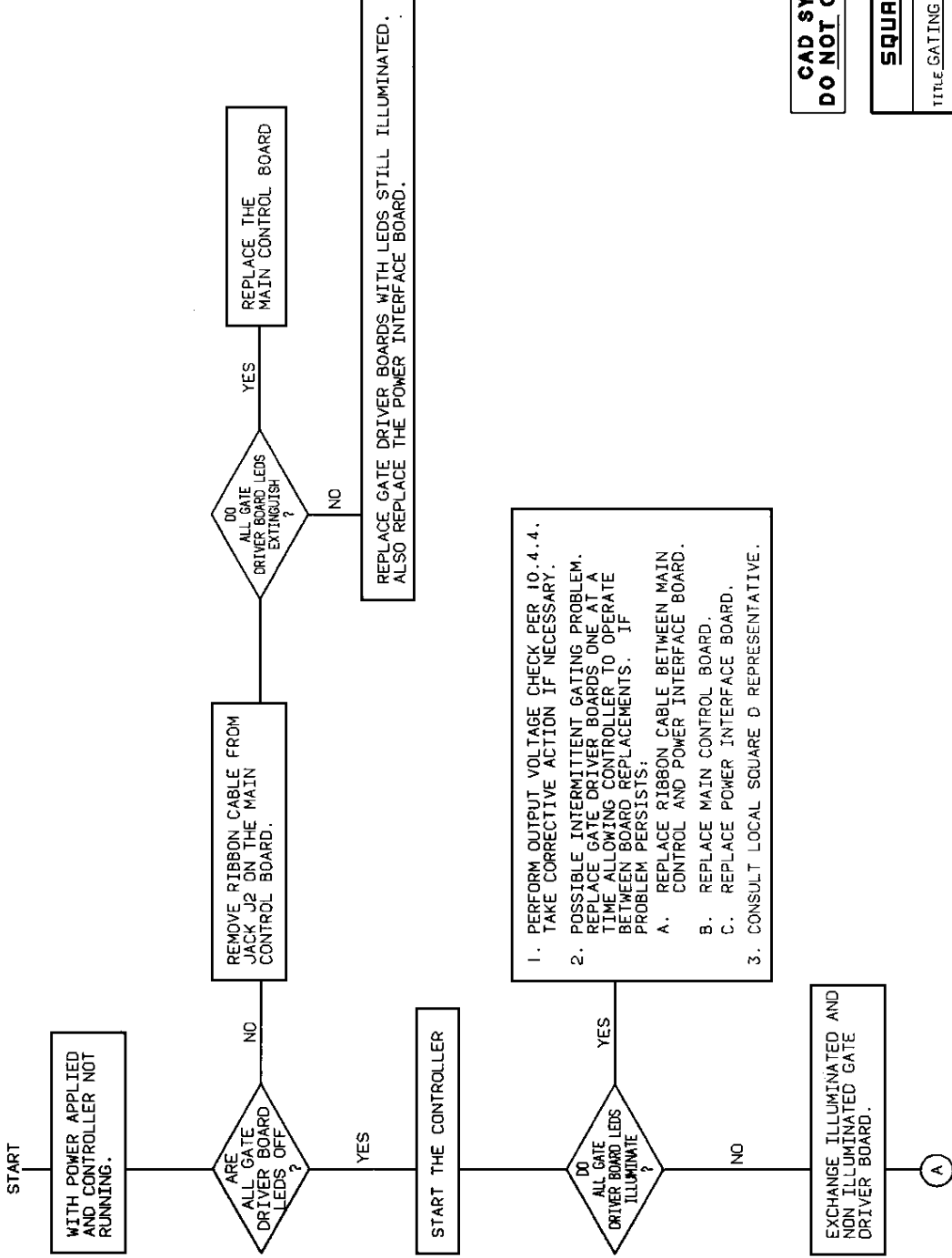

**CAD SYSTEM ORIGINAL.
DO NOT CHANGE MANUALLY.**

SQUARE D COMPANY

TITLE GATING

CLASS _____ TYPE _____ FORM _____ SER _____

DATE REL. _____ ORIG. NO. _____

DATE CHG. _____ 2-EDG _____

DATE _____ CHK. _____ CSD _____ APP'D _____

10.4.1

REF. _____

NEW ASSEMBLY _____

PROD. NO. _____

REV. DATE _____

REVISION DESCRIPTION _____

BY _____

10.4.1

CAD FILE

10.4.1

2

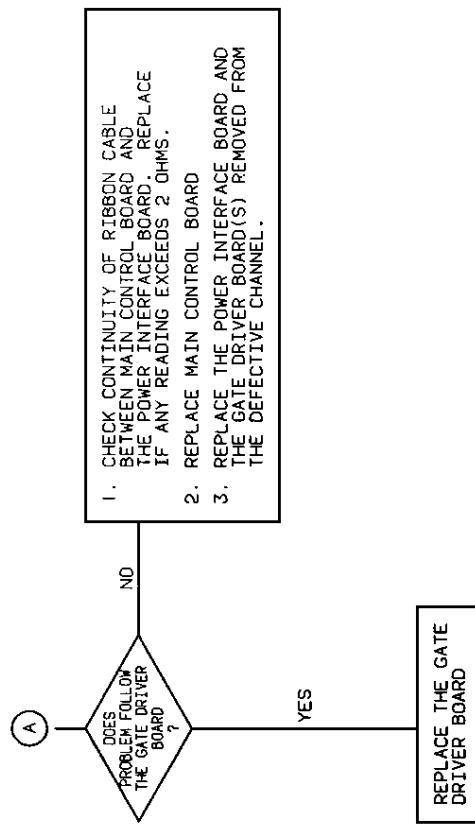

**CAD SYSTEM ORIGINAL.
DO NOT CHANGE MANUALLY.**

SQUARE D COMPANY
TITLE GATING
CLASS TYPE FORM SER

DATE CHG. 2-85
DATE REL. 10.4.1
DWA. CAD. APP'D
REF. ASSEM. PROJ. NO.
REV. DATE BY
REV. DATE BY

REF.	ASSEM.	PROJ. NO.	DATE CHG.	DATE REL.	DWA.	CAD.	APP'D	FORM	SER.
			2-85	10.4.1					
REV.	DATE	BY	REVISION DESCRIPTION						

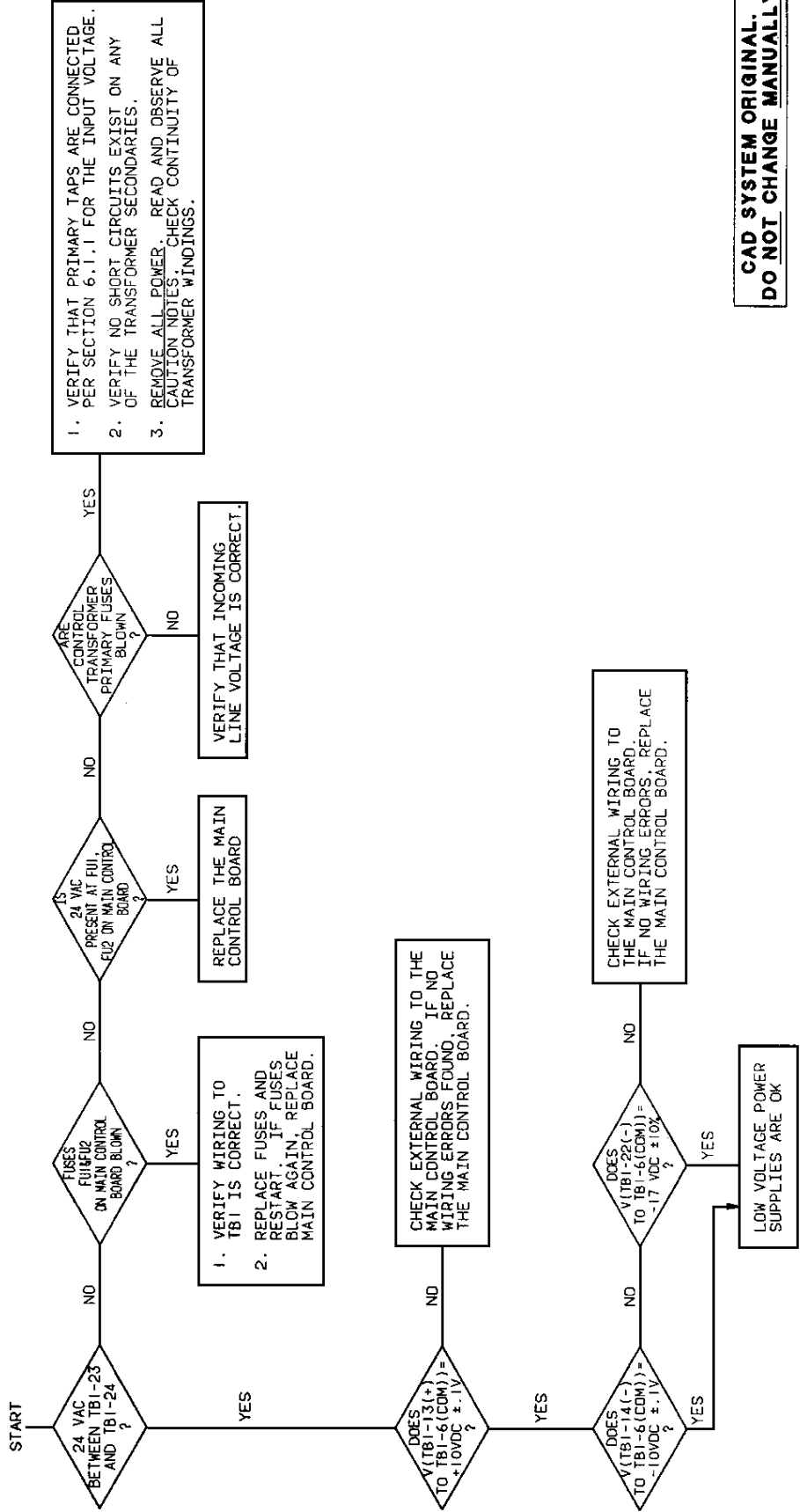

**CAD SYSTEM ORIGINAL.
DO NOT CHANGE MANUALLY.**

SQUARE D COMPANY
TITLE CONTROL POWER SUPPLY

CLASS _____ TYPE _____ FORM _____ SER. _____
DATE REC'D _____ DATE REL. _____ DRG. NO. _____
2-60 _____ DRW. _____ APP'D _____
REV. _____

10.4.3

10.4.3

REF. _____
DESIGN _____
PROJ. NO. _____

REVISION DESCRIPTION

REV. _____ DATE _____ BY _____

10.4.3

10.4.3

10.4.3

NOTE: Any reference to horsepower is at 460V unless stated otherwise. All controllers can be reconnected for 230V or 200V operation as detailed in Section 6.

CONTENTS

11.1 OMEGAPAK 1500 CONTROLLER DRAWINGS

- 11.1.1 Power elementary diagram
- 11.1.2 Control elementary diagram
- 11.1.3 Connection diagram
- 11.1.4 Outline diagram

11.2 CONTROL CIRCUIT ELEMENTARY DIAGRAMS (OMEGAPAK 1500 AND 3500 CONTROLLERS)

- 11.2.1 MOD S10, start-stop push buttons
- 11.2.2 MOD A10, hand-auto selector switch and start-stop push buttons
- 11.2.3 MOD H10, hand-off-auto selector switch
- 11.2.4 MODS S10 or F10, F11, J11 or B11, start-stop, fast stop push button, forward-reverse, run-jog selector switches
- 11.2.5 MODS H10, C13, B13 or D13, F08, T08, S08, A08, B08, C08, D08, hand-off-auto selector switch, isolation or bypass/isolation contactor, drive fail and auxiliary sequence relays no. 1 and no. 2
- 11.2.6 Fan relay and MODS P16, R16, F16, S16 power on, run, fail, incomplete sequence lights

11.3 OMEGAPAK 3500 DIAGRAMS

NOTE: Refer to OMEGAPAK 1500 controller diagrams 11.1.1-11.1.3 for controller detail

- 11.3.1 Connection diagram, basic single controller
- 11.3.2 Connection diagram MOD C13, single controller with isolation contactor
- 11.3.3 Connection diagram MOD B13 or D13, single controller with isolation/bypass
- 11.3.4 Connection diagram, dual controller
- 11.3.5 Elementary and connection diagram, isolation contactor
- 11.3.6 Elementary and connection diagram, isolation and bypass
- 11.3.7 Outline diagram

11.4 OPTIONAL DOOR MOUNTED PILOT DEVICES (OMEGAPAK 1500 AND 3500 CONTROLLERS)

- 11.4.1 Cable routing
- 11.4.2 Connection diagram MOD S10, start-stop push buttons and manual speed potentiometer
- 11.4.3 Connection diagram MOD F10, start-stop and fast stop push buttons and manual speed potentiometer
- 11.4.4 Connection diagram MOD A10, hand-auto selector switch, start-stop push buttons and manual speed potentiometer
- 11.4.5 Connection diagram MOD H10, hand-off-auto selector switch and manual speed potentiometer
- 11.4.6 Connection diagram MODS S10 (or F10) and F11 start-stop push buttons (or fast stop and start-stop push buttons) forward-reverse selector switch and manual speed potentiometer
- 11.4.7 Connection diagram MODS S10 (or F10) and J11 start-stop push buttons (or fast stop and start-stop push buttons) run-jog selector switch and manual speed potentiometer
- 11.4.8 Connection diagram MODS S10 (or F10), J11 and F11 (B11) start-stop push buttons (or fast stop and start-stop push buttons) run-jog and forward reverse selector switch and manual speed potentiometer
- 11.4.9 Connection diagram MODS P16, R16, F16 and S16 power on, run, drive fail and incomplete sequence lights

11.5 CONNECTION DIAGRAMS REMOTE OPERATOR STATIONS (OMEGAPAK 1500 AND 3500 CONTROLLERS)

- 11.5.1 Type CA-31 start-stop push buttons and manual speed potentiometer
- 11.5.2 Type CA-41 start-stop push buttons, run light and manual speed potentiometer
- 11.5.3 Type CA-42 hand-auto selector switch, start-stop push buttons and manual speed potentiometer

- 11.5.4 Type CA-43 start-stop push buttons, forward-reverse selector switch and manual speed potentiometer
- 11.5.5 Type CA-44 start-stop push buttons, forward-reverse selector switch and manual speed potentiometer
- 11.5.6 Type CA-61 start-stop push buttons, forward-reverse and run-jog selector switches and manual speed potentiometers
- 11.5.7 Type CA-62 start-stop push buttons, forward-reverse selector switch, run light and manual speed potentiometer
- 11.5.8 Type CA-63 start-stop push buttons, run-jog selector switch, run light and manual speed potentiometer
- 11.5.9 Type CA-64 start-stop push buttons, forward-reverse and run-jog selector switches, run light and manual speed potentiometer
- 11.5.10 Type CA-65 hand-auto selector switch, start-stop push buttons, run light and manual speed potentiometer

11.6 OPTION BOARD CONNECTION DIAGRAMS (OMEGAPAK 1500 AND 3500 CONTROLLERS)

- 11.6.1 MOD C07 (kit type MC-12) isolated follower
- 11.6.2 MOD A07 (kit type MC-11) non-isolated follower
- 11.6.3 MOD D07 (kit type MC-13) pneumatic follower
- 11.6.4 MOD B07 (kit type MC-14) non-isolated follower with run relay

11.7 MISCELLANEOUS (OMEGAPAK 1500 AND 3500 CONTROLLERS)

- 11.7.1 Meter connection diagram
- 11.7.2 Main control board terminal designation
- 11.7.3 Main control board block diagram

11.8 OPTIONAL DYNAMIC BRAKING (OMEGAPAK 1500 AND 3500 CONTROLLERS)

- 11.8.1 Connection diagram, dynamic braking resistor

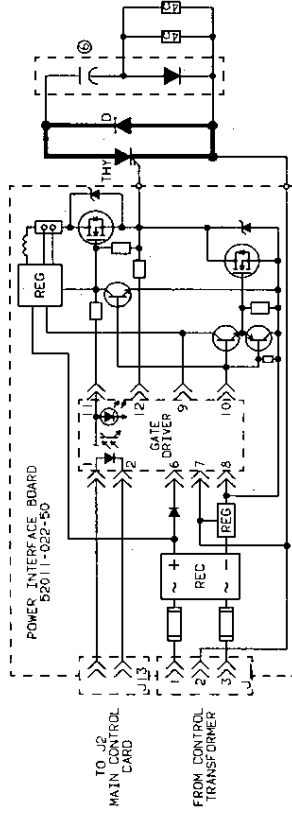
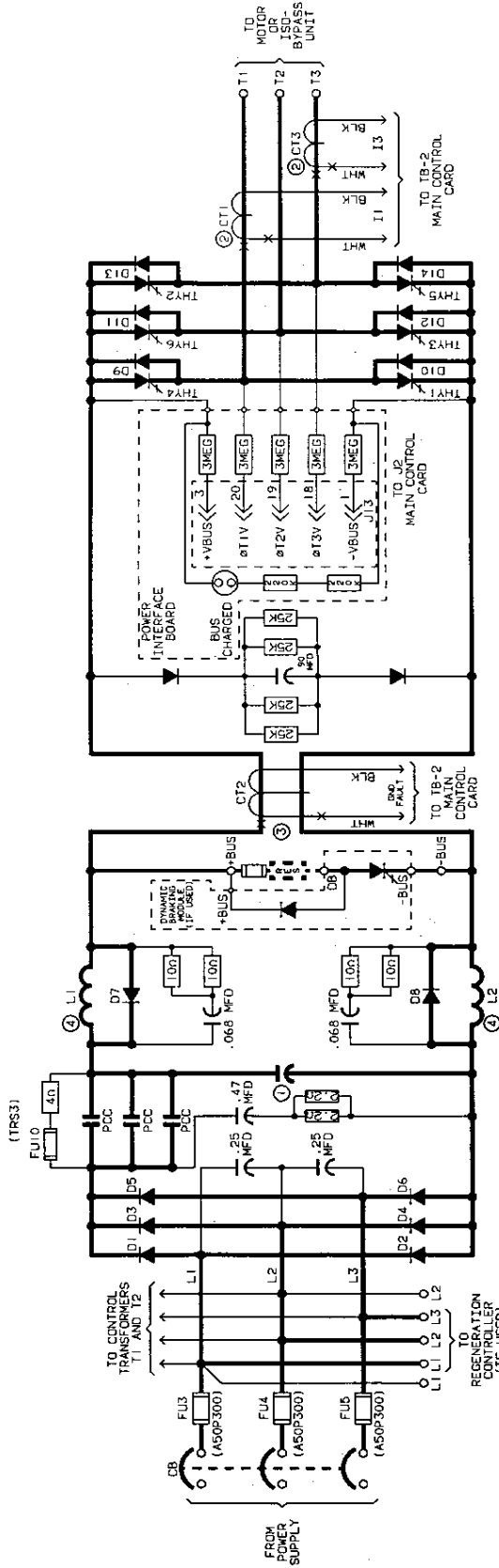

TYPICAL THYRISTOR GATING AND SNUBBER CIRCUIT FOR THY1 TO THY6

DRIVE H.P.		MOTOR CURRENT XFRS		INDO FAULT CURRENT XFRS		POWER SEMI-CONDUCTORS		INDUCTORS L1 AND L2		DYNAMIC BRAKING MODULE		CAPACITOR ASSEMBLY		TITLE	
NO. OF CAP CANS PER CAN	RATIO	NO. OF TURNS	PRI.	SEC.	RATIO	PRI.	SEC.	GT05	THY1-THY6	D1-D6	D7-D14	MFD	-BUS	+BUS	-BUS
50	10	600:5	1	0	600:5	1	0	52915-030-5001	52914-024-50	52914-028-92	51175-057-50	.75	52011-241-52	52011-241-55	52011-241-55
60	12	750:5	1	0	600:5	1	0	52915-030-5001	52914-024-50	52914-028-92	51175-057-50	.75	52011-241-52	52011-241-55	52011-241-55
75	15	1000:5	1	0	600:5	1	0	52915-030-5001	52914-024-50	52914-028-92	51175-057-50	1.05	52011-241-51	52011-241-54	52011-241-54
100	18	1200:5	1	0	600:5	1	0	52915-030-5001	52914-024-50	52914-028-92	51175-057-50	1.29	52011-241-50	52011-241-53	52011-241-53
125	23	1200:5	1	0	600:5	1	0	52915-030-5001	52914-024-50	52914-028-92	51175-057-50	1.29	52011-241-50	52011-241-53	52011-241-53

REV.	DATE	REVISION DESCRIPTION

DATE	REV.	BY	CHK.	APP.
5-85				

REFERENCE	52011-241-500

CLASS	8804	TYPE	FORM	SER.

DATE	REV.	BY	CHK.	APP.
5-85				

CAD SYSTEM ORIGINAL. DO NOT CHANGE MANUALLY.

SQUARE D COMPANY

TITLE ADJUSTABLE FREQUENCY CONTROLLER

POWER ELEMENTARY DIAGRAM (SD 10 125 HP)

CLASS 8804 TYPE FORM SER.

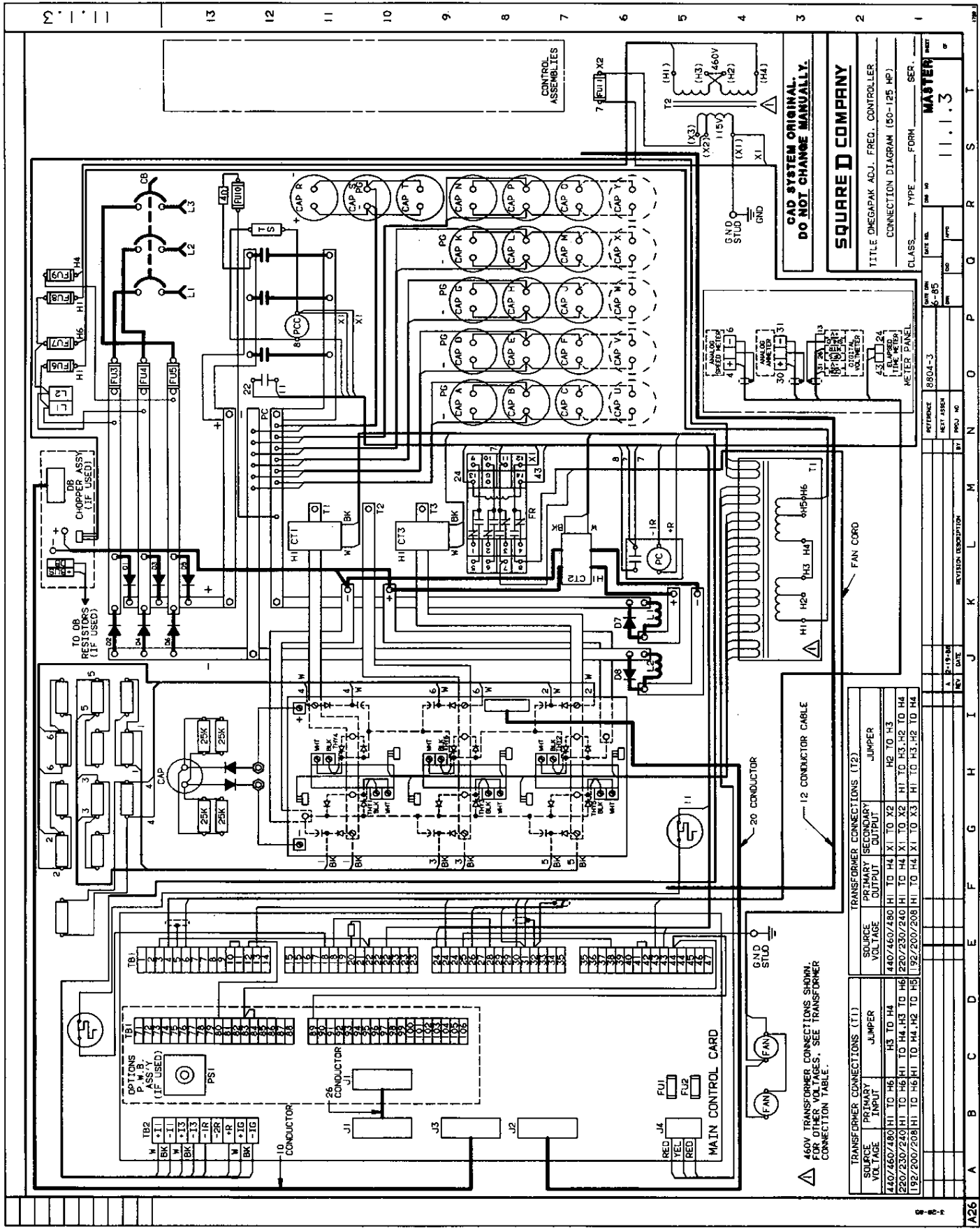

**GAD SYSTEM ORIGINAL.
DO NOT CHANGE MANUALLY.**

SQUARE D COMPANY

TITLE OMEGAPAK ADJ. FREQ. CONTROLLER
CONNECTION DIAGRAM (50-125 MP)

CLASS. TYPE _____ FORM _____ SER. _____

DATE _____
REV. NO. _____
BY _____
CHKD. _____
APP. _____

REFERENCE 8804-3
NEXT ISSUE _____
REV. DATE _____
REVISION DESCRIPTION _____

REV. NO. _____
DATE _____
BY _____
CHKD. _____
APP. _____

REV. NO. _____
DATE _____
BY _____
CHKD. _____
APP. _____

REV. NO. _____
DATE _____
BY _____
CHKD. _____
APP. _____

REV. NO. _____
DATE _____
BY _____
CHKD. _____
APP. _____

REV. NO. _____
DATE _____
BY _____
CHKD. _____
APP. _____

REV. NO. _____
DATE _____
BY _____
CHKD. _____
APP. _____

REV. NO. _____
DATE _____
BY _____
CHKD. _____
APP. _____

REV. NO. _____
DATE _____
BY _____
CHKD. _____
APP. _____

TRANSFORMER CONNECTIONS (T1)		TRANSFORMER CONNECTIONS (T2)	
SOURCE VOLTAGE	PRIMARY INPUT	PRIMARY OUTPUT	SECONDARY JUMPER
440/460/480	H1 TO H4	H1 TO H4	X1 TO X2
220/230/240	H1 TO H4	H1 TO H4	X1 TO X2
192/200/208	H1 TO H4	H1 TO H4	X1 TO X2

TRANSFORMER CONNECTIONS (T1)		TRANSFORMER CONNECTIONS (T2)	
SOURCE VOLTAGE	PRIMARY INPUT	PRIMARY OUTPUT	SECONDARY JUMPER
440/460/480	H1 TO H6	H1 TO H4	X1 TO X2
220/230/240	H1 TO H6	H1 TO H4	X1 TO X2
192/200/208	H1 TO H6	H1 TO H4	X1 TO X2

460V TRANSFORMER CONNECTIONS SHOWN FOR OTHER VOLTAGES. SEE TRANSFORMER CONNECTION TABLE.

A B C D E F G H I J K L M N O P

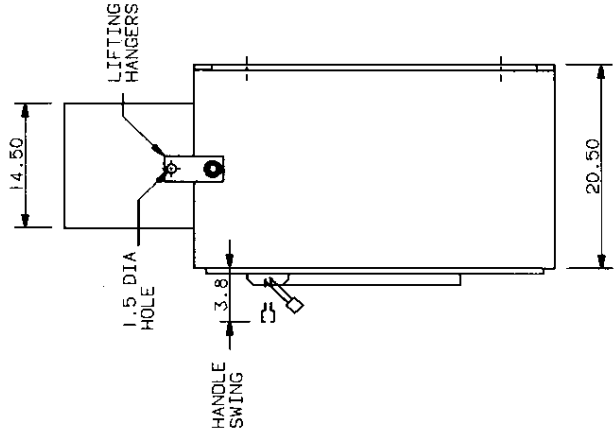
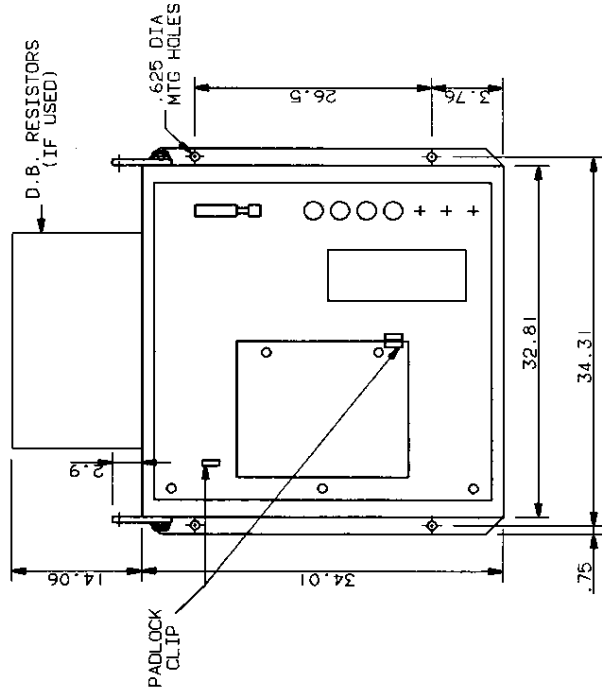
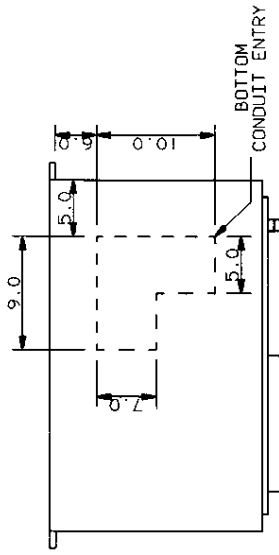
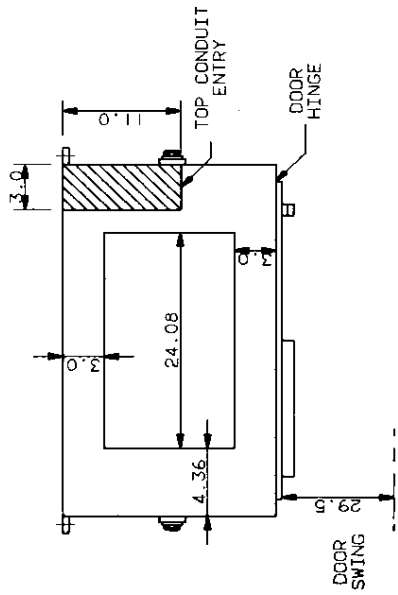

**CAD SYSTEM ORIGINAL.
DO NOT CHANGE MANUALLY.**

SQUARE D COMPANY
TITLE OMEGA PAK 1500 CONTROLLER
OUTLINE DRAWING
CLASS TYPE FORM SER.

DATE REC'D 6-85
DATE 499 0
FORM 11.1.4
SERIAL

REF. ASSEMBLY
PROD. NO.

REV. DATE
REVISION DESCRIPTION
BY

11.1.4

8

7

6

5

4

3

2

1

CAD SYSTEM ORIGINAL.
DO NOT CHANGE MANUALLY.

SQUARE D COMPANY

TITLE CONTROL CIRCUIT ELEMENTARY

START-STOP-RUN-JOG-FOR-REV-FAST STOP

CLASS TYPE FORM SER.

DATE CHG.	BY	DESCRIPTION
0-05		
REV.	DATE	DESCRIPTION
REF.	BY	DESCRIPTION
PROJ. NO.		
WKT. NO.		
DATE		
11.2.4		

SEE DRAWING 11.2.6

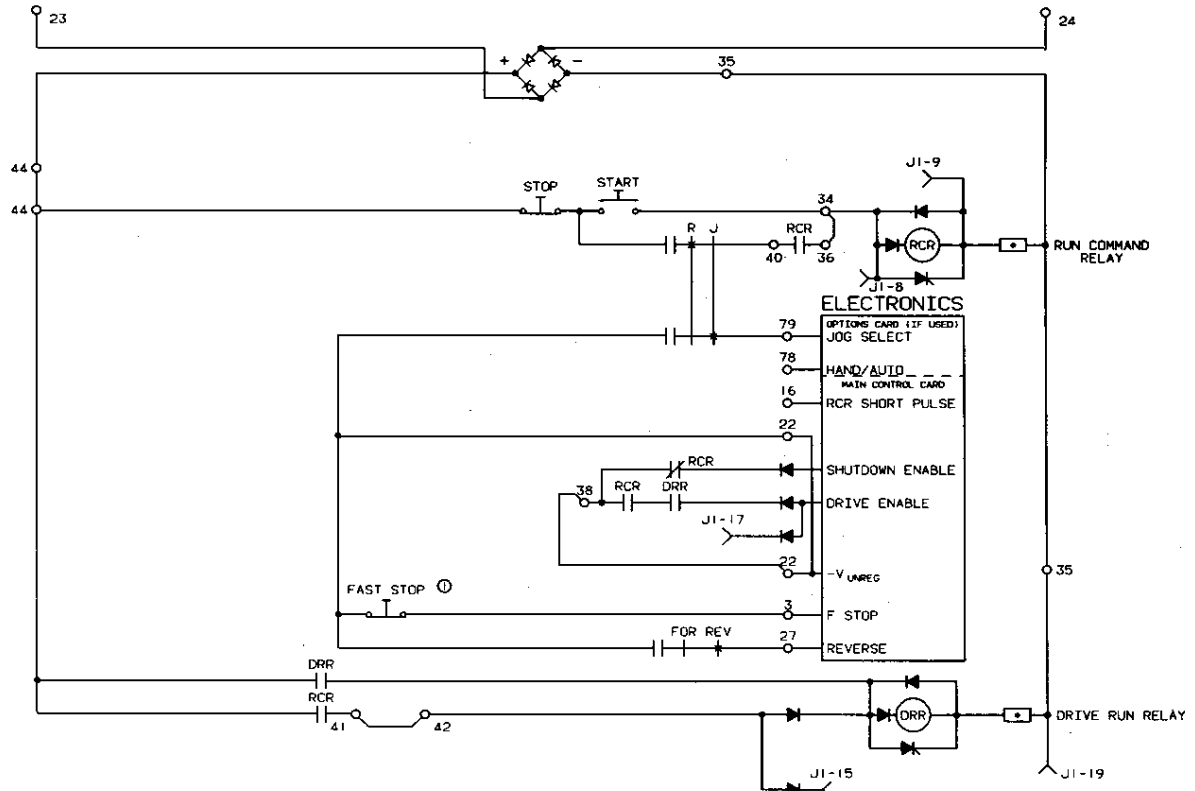

ELECTRONICS

OPTIONS CARD (IF USED):
 79 JOG SELECT
 78 HAND/AUID
 16 MAIN CONTROL CARD
 RCR SHORT PULSE
 22 SHUTDOWN ENABLE
 22 DRIVE ENABLE
 22 -V UNREG
 3 F STOP
 27 REVERSE

MOD. NO.'S. STD. DR. F10
J11 AND F11

* = 130 OHM, 5 WATTS

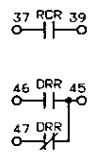

- ① SUPPLY WITH MOD. NO. F10 ONLY OTHERWISE JUMPER TB1-22 TO TB1-3
- ② OPTION BOARD TERMINALS 71-106

11.3.11

13

12

11

10

9

8

7

6

5

4

3

2

1

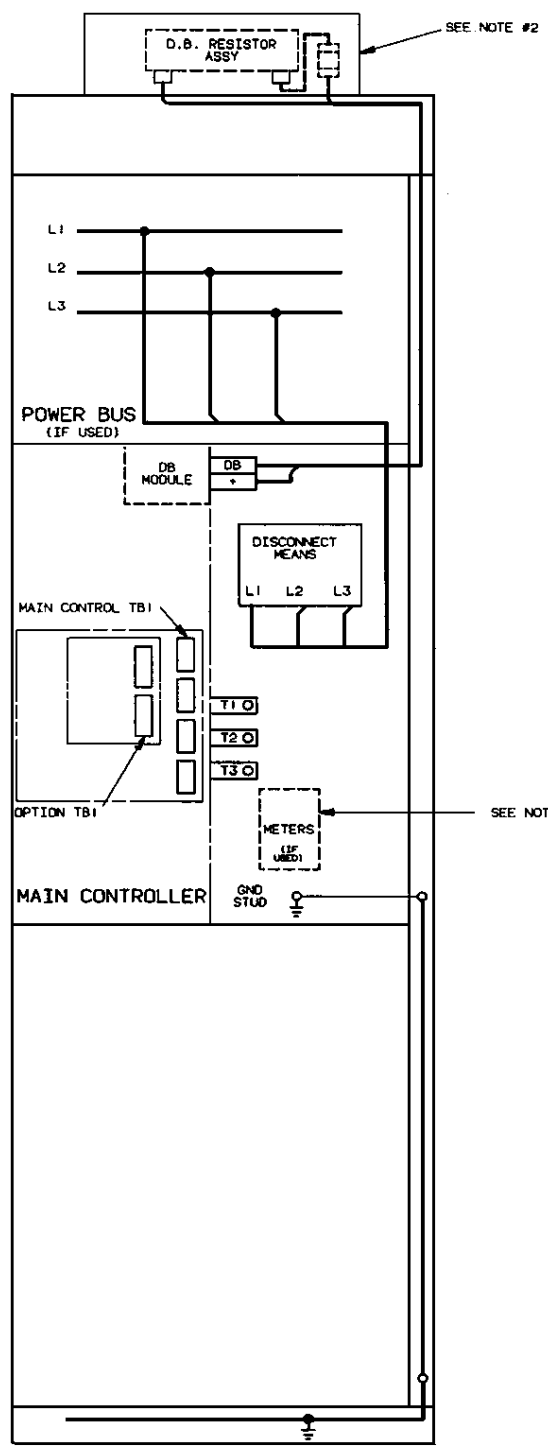

- NOTES:
- 1) FOR METER CONNECTIONS REFER TO DWG. 11.7.1
 - 2) FOR RESISTOR CONNECTIONS REFER TO DWG. 11.8.1
 - 3) ALL DEVICES SHOWN WITH DASHED LINES ARE TO BE WIRED PER DIAGRAM, IF USED.

CAD SYSTEM ORIGINAL.
DO NOT CHANGE MANUALLY.

SQUARE D COMPANY

TITLE OMEGAPAK 3500 CONT. 50-125 H.P.

WITH DISCONNECT

CLASS TYPE FORM SER.

DATE REV. 5-85

DATE REV. 11.3.11

DATE REV. MASTER

REV.	DATE	DESCRIPTION	BY	CHKD.	APP'D.
1	12-14-85				
2					
3					
4					
5					
6					
7					
8					
9					
10					
11					
12					
13					

A B C D E F G H I J K L M N O P Q R S T

SEE NOTE #2

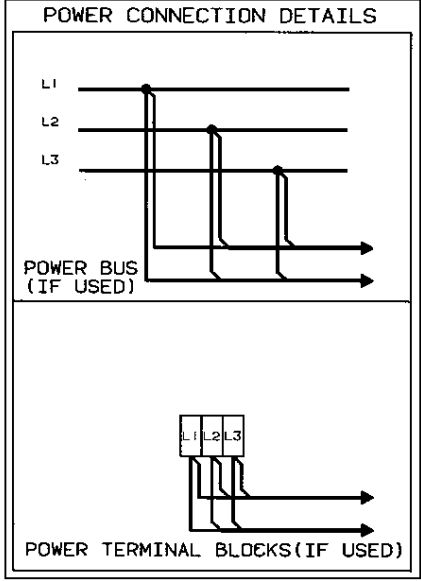
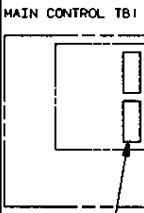
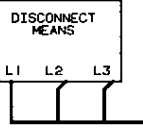
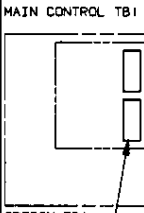
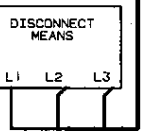
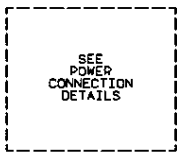
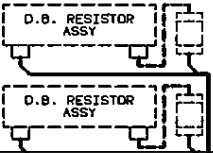

- NOTES:
- 1) FOR METER CONNECTIONS REFER TO DWG 11.7.1
 - 2) FOR RESISTOR CONNECTIONS REFER TO DWG 11.8.1
 - 3) ALL DEVICES SHOWN WITH DASHED LINES ARE TO BE WIRED PER DIAGRAM, IF USED.

SEE NOTE #1

SEE NOTE #1

CAD SYSTEM ORIGINAL. DO NOT CHANGE MANUALLY.

SQUARE D COMPANY

TITLE: MEGAPAK 3500 CONT. 50-125 H.P. WITH DISCONNECT (2 HIGH ARRANGEMENT)

CLASS. TYPE FORM SER. MASTER 11.3.4

DATE CHG	BY	DESCRIPTION
6-95		
8801-3		
REV	DATE	DESCRIPTION
1	12-14-91	
2		
3		
4		
5		
6		
7		
8		
9		
10		
11		
12		
13		

A B C D E F G H I J K L M N O P Q R S T

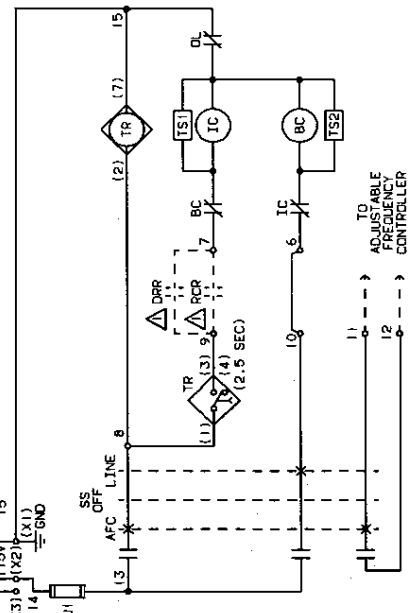
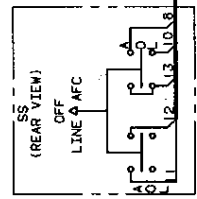
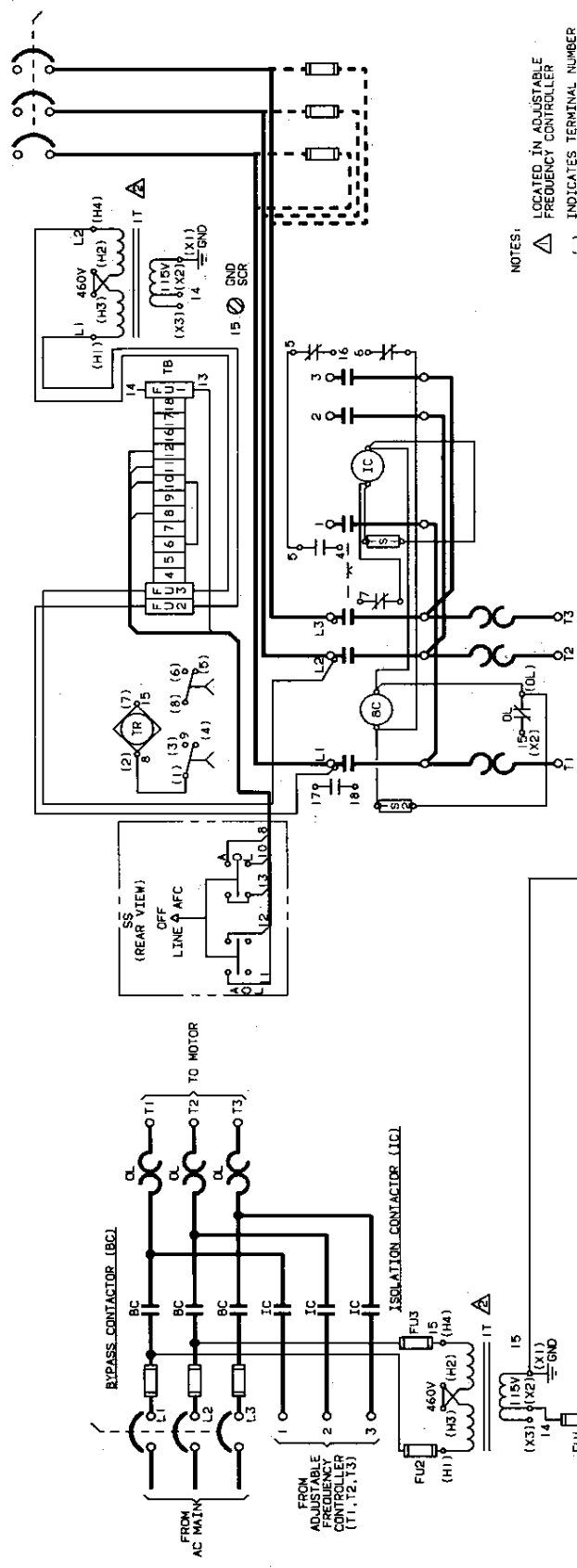

NOTES:
 △ LOCATED IN ADJUSTABLE FREQUENCY CONTROLLER
 () INDICATES TERMINAL NUMBER ON DEVICE
 △ 460V TRANSFORMER CONNECTIONS SHOWN FOR OTHER VOLTAGES. SEE TRANSFORMER CONNECTION TABLE.

TRANSFORMER CONNECTIONS		
SOURCE VOLTAGE	PRIMARY INPUT	SECONDARY OUTPUT JUMPER
440/460/480	H1 TO H4	X1 TO X2 H2 TO H3
220/230/240	H1 TO H4	X1 TO X2 H1 TO H3 H2 TO H4
192/200/208	H1 TO H4	X1 TO X3 H1 TO H3 H2 TO H4

WIRE TABLE		DEVICE DESIGNATION
WIRE NO	SIZE AND COLOR	EXISTING NUMBERS ON IC AND BC
1	3	IC, TB
2	16 GA RED	IC, TB
3	2	BC, TB
4	16 GA	TR, TB, SS
5	7	TR, TB, SS
6	2	IC, TB
7	10	IC, TB
8	10	IC, TB
9	10	IC, TB
10	10	IC, TB
11	12	IC, TB
12	12	IC, TB
13	13	IC, TB
14	14	IC, TB
15	15	IC, TB
16	16	IC, TB
17	17	IC, TB
18	18	IC, TB

CAD SYSTEM ORIGINAL. DO NOT CHANGE MANUALLY.

SQUARE D COMPANY

TITLE BY-PASS AND ISOLATION CONTACTORS

CLASS 8804 TYPE _____ FORM _____ SER. _____

DATE REV. 6-85

REV. NO. 11,3,6

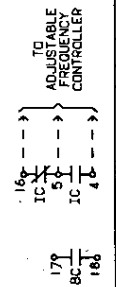

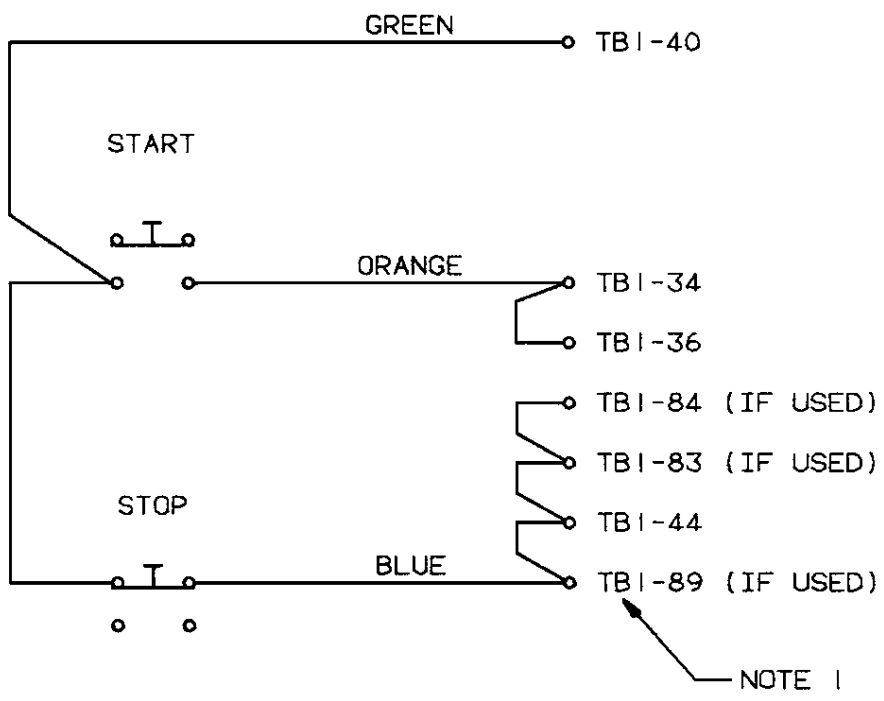
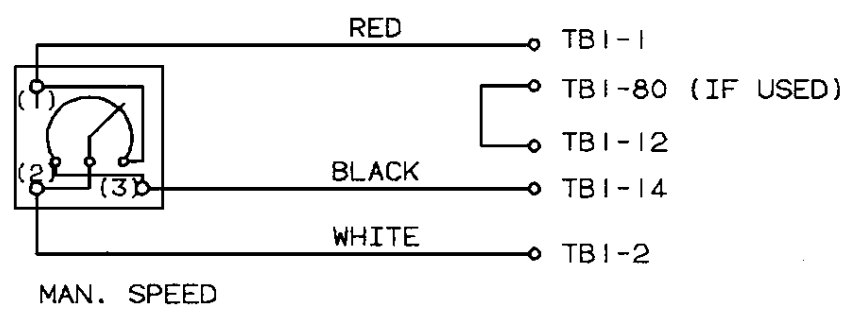

NOTES:

- 1) IF OPTIONS BOARD IS NOT USED, CONNECT BLUE WIRE TO TBI-44
- 2) TERMINALS 71-106 ARE LOCATED ON THE OPTIONS BOARD.

MOD. NO. S10

**CAD SYSTEM ORIGINAL
DO NOT CHANGE MANUALLY.**

SQUARE D COMPANY
 TITLE CONNECTION DIAGRAM
 START-STOP, MAN. SPD.
 CLASS _____ TYPE _____ FORM _____ SER. _____

REF.	DATE DRN.	DATE REL.	DRG. NO.	ELEC FILE	SHEET
NEXT ASSEM.	6-85		11.4.2		
PROJ. NO.	DRN.	CHK.	APP'D	OF	

A B C D E F

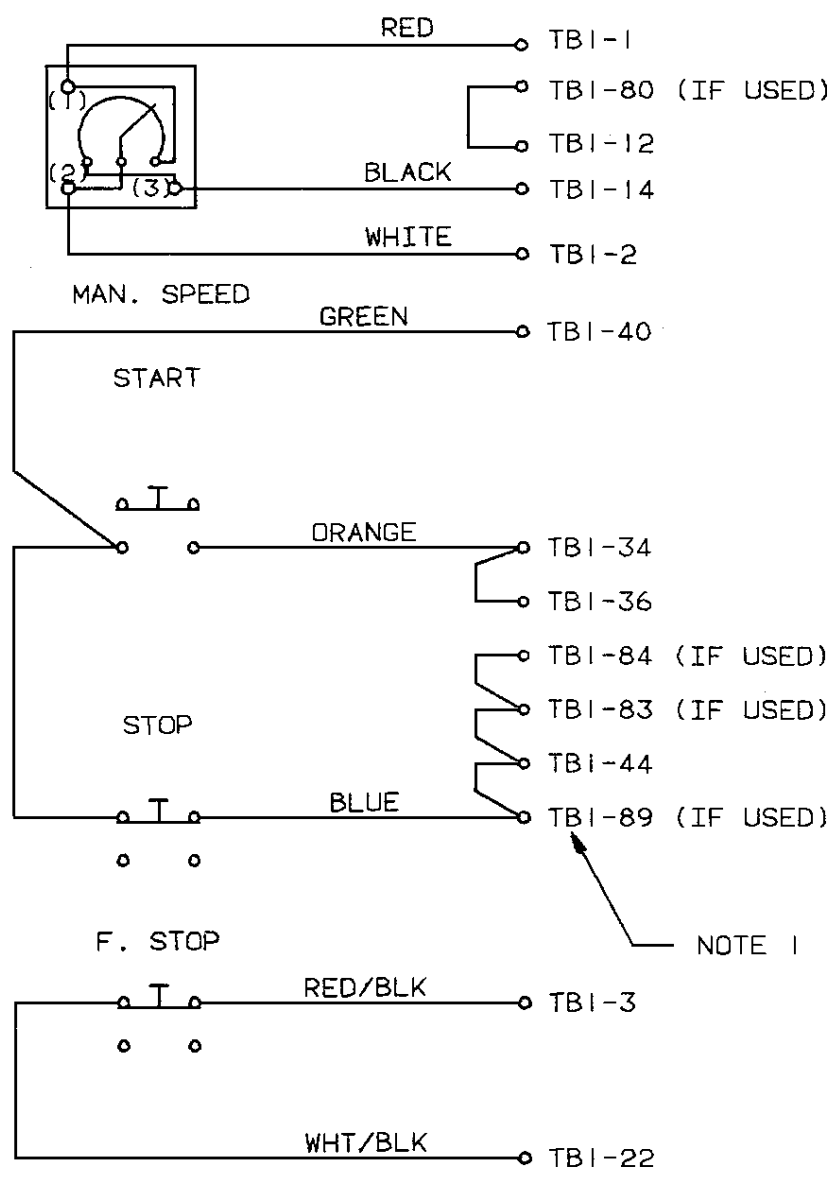

8
7
6
5
4
3
2
1

NOTES:

- 1) IF OPTIONS BOARD IS NOT USED CONNECT BLUE WIRE TO TBI-44
- 2) TERMINALS 71-106 ARE LOCATED ON THE OPTIONS BOARD.

MOD. NO. F10

**CAD SYSTEM ORIGINAL
DO NOT CHANGE MANUALLY.**

SQUARE D COMPANY

TITLE CONNECTION DIAGRAM
START-STOP, FAST-STOP, MAN. SPD.

CLASS _____ TYPE _____ FORM _____ SER. _____

REF.	DATE DRN.	DATE REL.	DRG. NO.	ELEC FILE	SHEET
NEXT ASSEM.	6-85				
PROJ. NO.	DRN.	CRD.	APP'D	11.4.3	OF

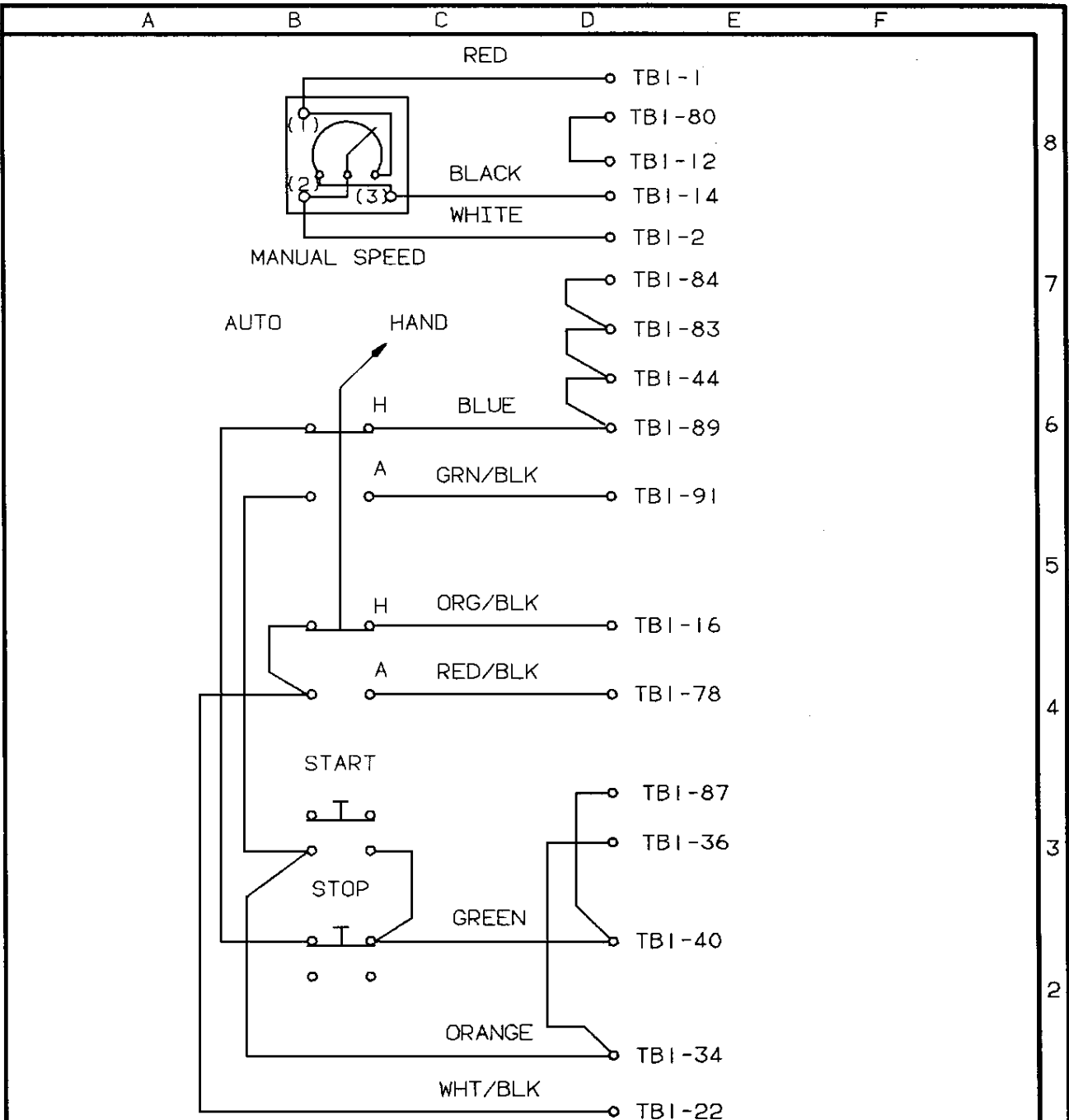

MOD. NO. A10

**CAD SYSTEM ORIGINAL
DO NOT CHANGE MANUALLY.**

NOTES:

1) TERMINALS 71-106 ARE LOCATED ON THE OPTIONS BOARD.

SQUARE D COMPANY

TITLE CONNECTION DIAGRAM
HAND-AUTO START-STOP MAN. SPD

CLASS TYPE FORM SER.

REF.	DATE DRN.	DATE REL.	DRG. NO.	ELEC FILE	SHEET
NEXT ASSEM	6-85		11.4.4		
PROJ. NO.	DRN.	CRD.	APP'D	or	

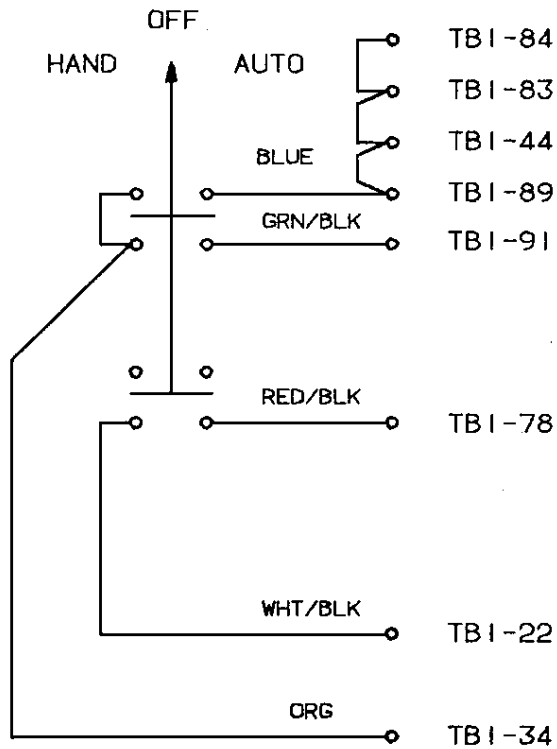
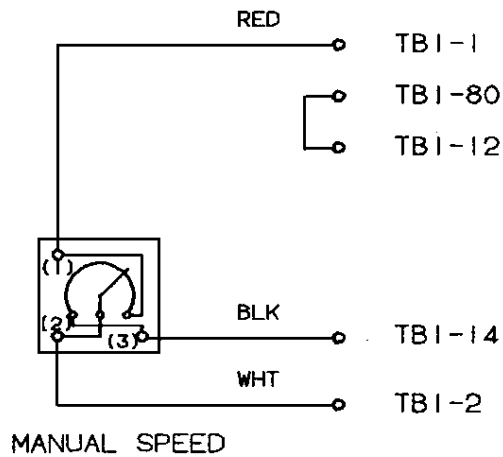

**CAD SYSTEM ORIGINAL
DO NOT CHANGE MANUALLY.**

SQUARE D COMPANY
 TITLE CONNECTION DIAGRAM
 HAND-OFF-AUTO, MAN. SPEED
 CLASS TYPE FORM SER.

NOTE:
 1) TERMINALS 71-106 ARE LOCATED
 ON THE OPTIONS BOARD.

REF.	DATE DRN.	DATE REL.	DRG. NO.	ELEC FILE	SHEET
NEXT ASSEM.	6-85		11.4.5		
PROJ. NO.	DRN.	CHK.	APP'D	OF	

FOR REV

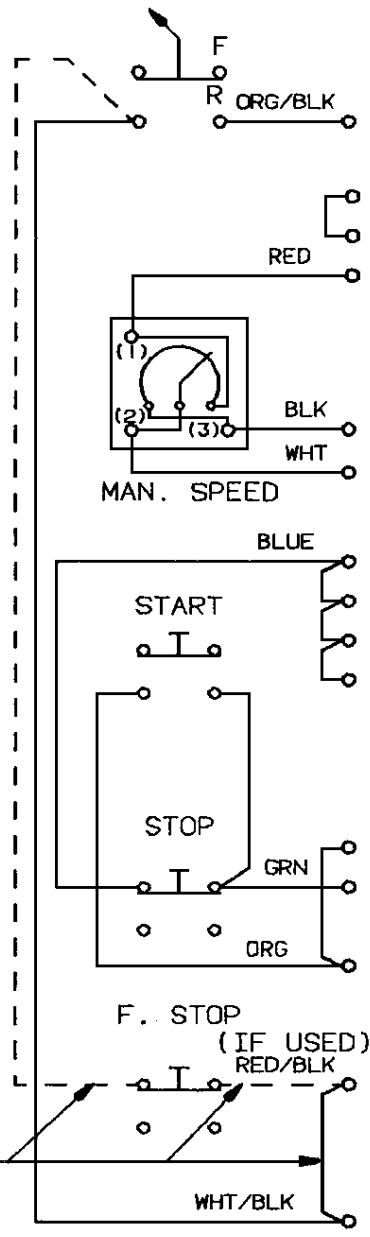

NOTE 2

NOTE 1

MOD. NO.'S S10 OR F10 AND F11

- NOTE:
- 1) IF FAST STOP IS USED, JUMPER FROM TB1-3 TO TB1-22 IS REMOVED AND DOTTED CONNECTIONS ARE MADE.
 - 2) IF OPTION BOARD IS NOT USED CONNECT BLUE WIRE TO TB1-44.

**CAD SYSTEM ORIGINAL
DO NOT CHANGE MANUALLY.**

SQUARE D COMPANY

TITLE CONNECTION DIAGRAM FOR-REV
START-STOP,FAST STOP MAN SPD

CLASS _____ TYPE _____ FORM _____ SER. _____

REF.	DATE DRN.	DATE REL.	DRG. NO.	ELEC FILE	SHEET
NEXT ASSEM	6-85		11.4.6		
PROJ. NO.	DRN.	CHK.	APP'D		OF

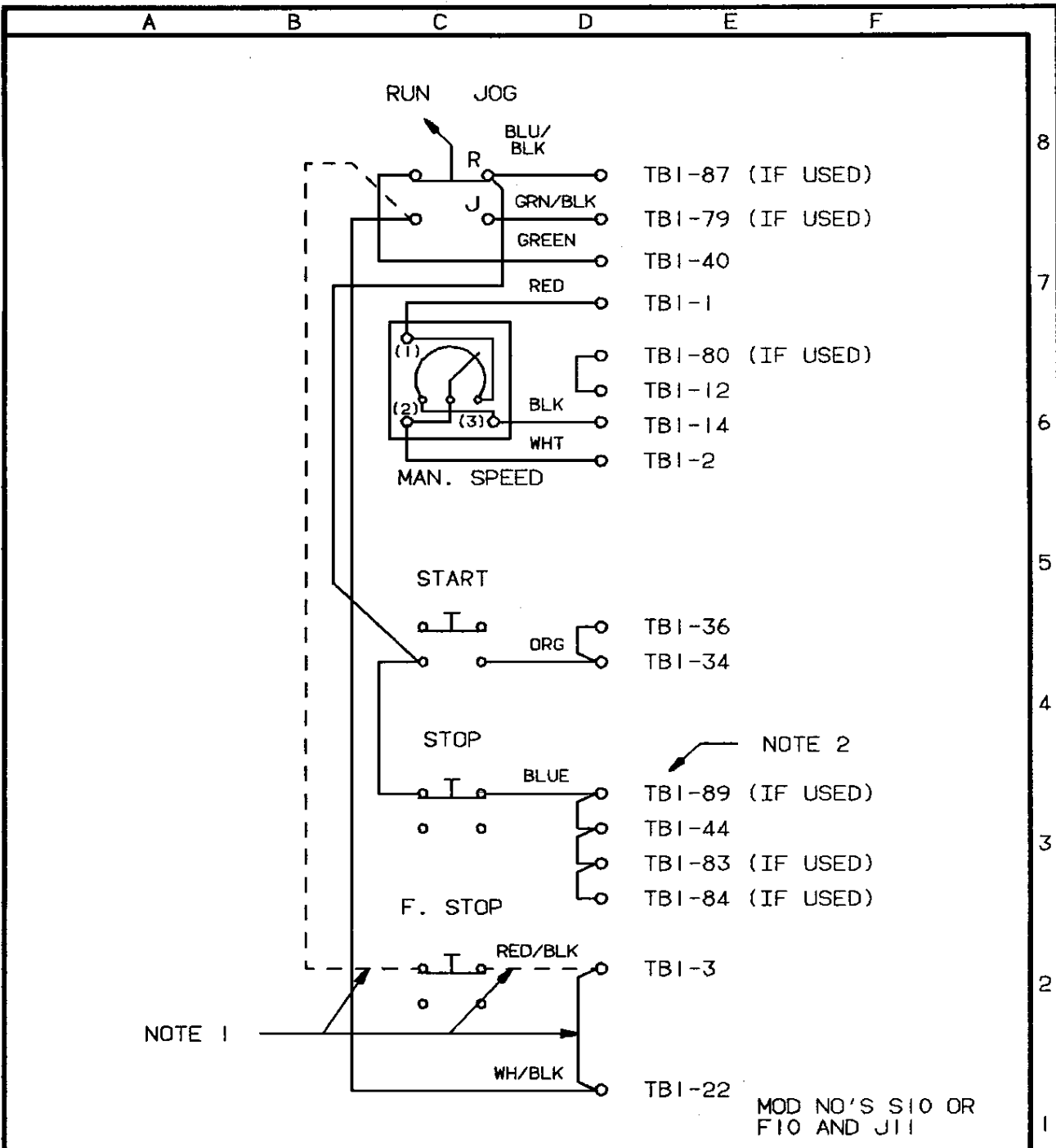

- NOTE:
- 1) IF FAST STOP IS USED, JUMPER FROM TB1-3 TO TB1-22 IS REMOVED AND DOTTED CONNECTIONS ARE MADE.
 - 2) IF OPTION BOARD IS NOT USED, CONNECT BLUE WIRE TO TB1-44.

**CAD SYSTEM ORIGINAL
DO NOT CHANGE MANUALLY.**

SQUARE D COMPANY

TITLE CONNECTION DIAGRAM RUN JOG,
START-STOP, FAST STOP, MAN. SPD

CLASS _____ TYPE _____ FORM _____ SER. _____

REF.	DATE DRN.	DATE REL.	DRG. NO.	ELEC FILE	SHEET
NEXT ASSEM.	6-85		11.4.7		
PROJ. NO.	DRN.	CHK.	APP'D	OF	

A B C D E F

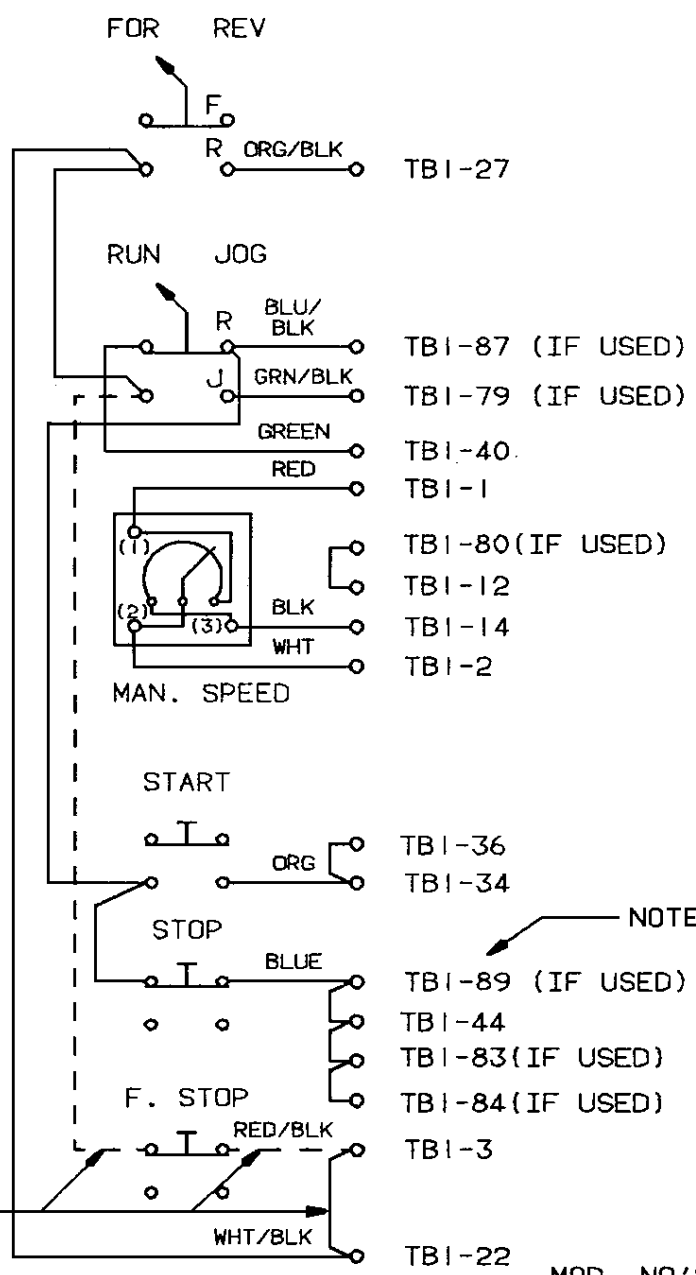

NOTE 1

NOTE 2

- NOTE:
- 1) IF FAST STOP IS USED, JUMPER FROM TBI-3 TO TBI-22 IS REMOVED AND DOTTED CONNECTIONS ARE MADE.
 - 2) IF OPTION BOARD IS NOT USED, CONNECT BLUE WIRE TO TBI-44.

MOD. NO'S S10 OR F10
J11 AND F11

**CAD SYSTEM ORIGINAL
DO NOT CHANGE MANUALLY.**

SQUARE D COMPANY

TITLE CONNECTION DIAGRAM FOR-REV.
RUN-JOG, START-STOP, FAST STOP, MAN SPD.
CLASS _____ TYPE _____ FORM _____ SER. _____

REF.	DATE DRN.	DATE REL.	DRG. NO.	ELEC FILE SHEET
NEXT ASSEN.	6-85		11.4.8	
PROJ. NO.	DRN.	CHK.	APP'D	OF

A B C D E F

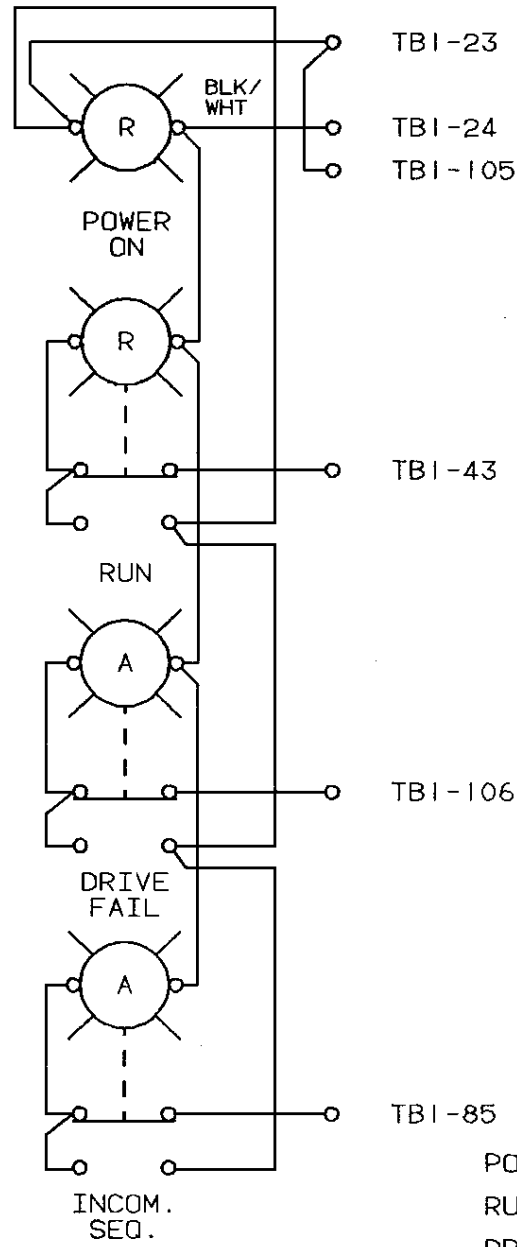

8
7
6
5
4
3
2

POWER ON -MOD. NO. P16
 RUN -MOD. NO. R16
 DRIVE FAIL -MOD. NO. F16
 INCOMPLETE SEQ. -MOD. NO. S16

**CAD SYSTEM ORIGINAL
 DO NOT CHANGE MANUALLY.**

NOTE:
 1) TERMINALS 71-106 ARE LOCATED ON
 THE OPTIONS BOARD (IF USED)

SQUARE D COMPANY
 TITLE CONNECTION DIAGRAM
 DOOR MOUNTING PILOT LIGHTS
 CLASS TYPE FORM SER.

REF.	DATE DRN.	DATE REL.	DRG. NO.	ELEC FILE	SHEET
NEXT ASSEM.	6-85				
PROJ. NO.	DRN.	CHK.	APP'D	11.4.9	OF

MANUAL SPEED, START-STOP
RUN-JOG

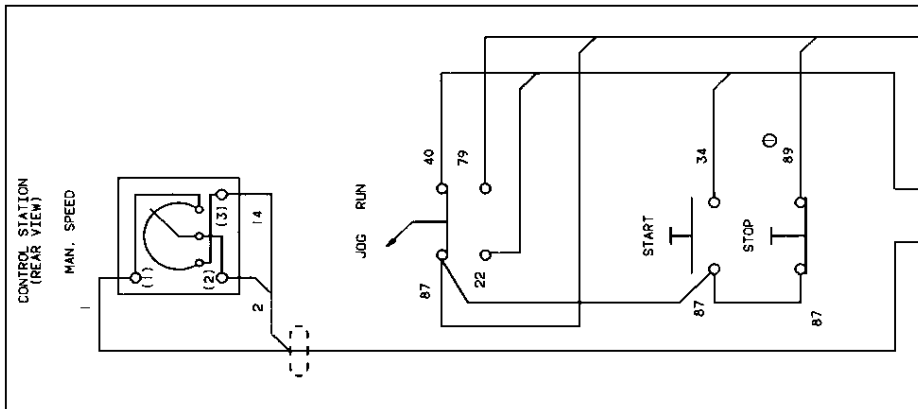

ADJUSTABLE FREQUENCY CONTROLLER
(FRONT VIEW)

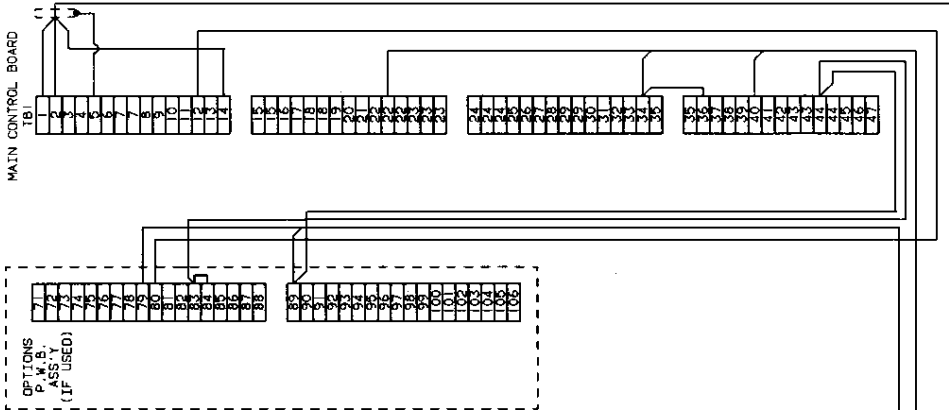

LOW LEVEL CONTROL WIRING. THESE CONDUCTORS MAY BE ROUTED IN THE SAME ENCASEMENT MAINWAIN 3" SEPARATION (CONDUIT) OR 12" SEPARATION (TRAY) FROM OTHER TYPES OF POWER OR CONTROL WIRING. ALL CONDUCTORS TO BE #18 AWG MINIMUM. SHIELDED CABLE TO BE JACKETED. GROUND SHIELD ONLY WHERE SHOWN. INSULATE OTHER END OF SHIELDED CABLE.

NOTE: IF OPTION BOARD NOT USED WIRE TO TB1-44

**CAD SYSTEM ORIGINAL
DO NOT CHANGE MANUALLY.**

SQUARE D COMPANY

TITLE CONNECTION DIAGRAM TYPE CA-44

REMOTE OPERATOR STATION

CLASS _____ TYPE _____ FORM _____ SER. _____
DATE REC. _____ DATE REC. _____
BY _____ BY _____
REV. _____ REV. _____
REVISION DESCRIPTION

DATE REC.	DATE REC.	BY	BY	REV.	DATE	REVISION DESCRIPTION
11.5.5						

12.0 RENEWAL PARTS LIST

Description	Square D Part Number		
	Constant Torque		Variable Torque
Main Control Board	52011-038-51		52011-038-53
Gate Driver Board	52011-003-50		52011-003-50
Power Interface Board	52011-022-50		52011-022-50
GTO (Thy 1 – Thy 6)	52915-030-5001		52915-030-5001
Rectifier Diode (D1-D6)	52915-024-50		52914-024-50
Flyback Diode (D7-D14)	52914-028-52		52914-028-52
Fuse (120V control, Primary — FU8, FU9) KTK-10	25419-10141		25419-10141
Fuse (120V control, Secondary — FU11) FRN-5	25413-00230		25413-00230
Fuse (Precharge Resistor — FU10) TRS 3	25428-00030		25428-00030
Fuse (24V Control, Primary — FU6, FU7) KTK-10	25419-10141		25419-10141
Fuse (Line-FU3-FU5) A50P300	25418-60300		25418-60300
Fuse (Main Control Board — FU1, FU2) MDL-5.0	25420-30500		25420-30500
DC Bus Capacitor	52904-018-50		52904-018-50
Fan Relay	8501 RS14 24VAC Coil		8501 RS14 24VAC Coil
Precharge Relay	52905-024-50		52905-024-50
Precharge Contactor Coil	31074-40038		31074-40038
Snubber Assembly Plus Bus (3)	50-60 HP Pt. No. 52011-241-52	75 HP Pt. No. 52011-241-50	100-125 HP Pt. No. 52011-241-50
Minus Bus (3)	52011-241-55	52011-241-54	52011-241-53
Dynamic Braking Resistor Fuse (If Used)	50-75 HP Pt. No. 25428-00150	100-125 HP Pt. No. 25428-00200	
Isolation or Isolation/Bypass (If Used)			
Control Transformer	Primary Fuses (FU2, FU3) KTK-10		Pt. No. 25419-10141
Control Transformer	Secondary Fuse (FU1) FNQ5		25419-60500
Contacto Coil	50-100 HP Pt. No. 31074-40038		125 HP Pt. No. 31091-40038

