

E7 Drive Programming Manual

*This Manual
also available on
www.drives.com*



Model: E7U

Document Number: TM.E7.02

Quick Reference for E7 Parameters

Parameter Number	Factory Setting	User Setting	Parameter Number	Factory Setting	User Setting	Parameter Number	Factory Setting	User Setting	Parameter Number	Factory Setting	User Setting
A1-00	0		b5-06	100		E1-06	60		L3-06	120	
A1-01	2		b5-07	0		E1-07	3		L4-01	0	
A1-03	0		b5-08	0		E1-08	18		L4-02	2	
A1-04	0		b5-09	0		E1-09	1.5		L4-05	1	
A1-05	0		b5-10	1		E1-10	10.8		L4-06	80	
A2-01			b5-11	0		E1-11	0		L5-01	0	
A2-02			b5-12	0		E1-12	0		L5-02	0	
A2-03			b5-13	0		E1-13	0		L5-03	180	
A2-04			b5-14	1		E2-01	kVA Dep.		L6-01	6	
A2-05			b5-15	0		E2-03	kVA Dep.		L6-02	15	
A2-06			b5-16	0		E2-05	kVA Dep.		L6-03	10	
A2-07			b5-17	0		F6-01	1		L8-01	0	
A2-08			b5-18	0		F6-02	0		L8-02	kVA Dep.	
A2-09			b5-19	0		F6-03	1		L8-03	4	
A2-10			b5-20	1		F6-05	0		L8-06	kVA Dep.	
A2-11			b5-21	1		H1-01	24		L8-09	1	
A2-12			b5-22	0		H1-02	14		L8-10	0	
A2-13			b5-23	0		H1-03	3		L8-11	300	
A2-14			b5-24	0		H1-04	4		L8-12	45	
A2-15			b5-25	0		H1-05	6		L8-15	1	
A2-16			b5-26	0		H2-01	0		L8-18	1	
A2-17			b5-27	60		H2-02	A		L8-19	20	
A2-18			b5-28	0		H3-02	100		n1-01	1	
A2-19			b5-29	1		H3-03	0		n1-02	1	
A2-20			b5-30	0		H3-08	2		n3-01	5	
A2-21			b8-01	0		H3-09	2		n3-02	150	
A2-22			b8-04	kVA Dep.		H3-10	100		n3-03	1	
A2-23			b8-05	20		H3-11	0		n3-04	40	
A2-24			b8-06	0		H3-12	0.3		o1-01	6	
A2-25			C1-01	30		H3-13	0		o1-02	1	
A2-26			C1-02	30		H4-01	2		o1-03	0	
A2-27			C1-03	30		H4-02	100		o1-05	3	
A2-28			C1-04	30		H4-03	0		o1-06	0	
A2-29			C1-09	10		H4-04	8		o1-07	2	
A2-30			C1-11	0		H4-05	50		o1-08	3	
A2-31			C2-01	0.2		H4-06	0		o2-01	1	
A2-32			C2-02	0.2		H4-07	0		o2-02	1	
b1-01	1		C4-01	1		H4-08	0		o2-03	0	
b1-02	1		C4-02	200		H5-01	1F		o2-04	kVA Dep.	
b1-03	0		C6-02	kVA Dep.		H5-02	3		o2-05	1	
b1-04	1		C6-03	kVA Dep.		H5-03	0		o2-06	1	
b1-07	0		C6-04	kVA Dep.		H5-04	3		o2-07	0	
b1-08	0		C6-05	0		H5-05	1		o2-08	1	
b1-11	0		d1-01	0		H5-06	5		o2-09	1	
b1-12	0		d1-02	0		H5-07	1		o2-10	0	
b2-01	0.5		d1-03	0		H5-08	0		o2-12	0	
b2-02	50		d1-04	0		H5-09	2		o2-14	0	
b2-03	0		d1-17	6		L1-01	1		o2-15	1	
b2-04	0		d2-01	100		L1-02	8		o3-01	0	
b2-09	0		d2-02	0		L1-03	3		o3-02	0	
b3-01	2		d2-03	0		L1-04	1		T1-02	kVA Dep.	
b3-02	120		d3-01	0		L1-05	0.2		T1-04	kVA Dep.	
b3-03	2		d3-02	0		L2-01	2				
b3-05	0.2		d3-03	0		L2-02	kVA Dep.				
b3-14	1		d3-04	1		L2-03	kVA Dep.				
b4-01	0		d4-01	0		L2-04	kVA Dep.				
b4-02	0		d4-02	10		L2-05	Voltage Dep.				
b5-01	0		E1-01	240V or 480V		L3-01	1				
b5-02	2		E1-03	F		L3-02	120				
b5-03	5		E1-04	60		L3-04	1				
b5-04	100		E1-05	240V or 480V		L3-05	1				

Warnings and Cautions

This Section provides warnings and cautions pertinent to this product, that if not heeded, may result in personal injury, fatality, or equipment damage. Yaskawa is not responsible for consequences of ignoring these instructions.

WARNING

YASKAWA manufactures component parts that can be used in a wide variety of industrial applications. The selection and application of YASKAWA products remain the responsibility of the equipment designer or end user. YASKAWA accepts no responsibility for the way its products are incorporated into the final system design. Under no circumstances should any YASKAWA product be incorporated into any product or design as the exclusive or sole safety control. Without exception, all controls should be designed to detect faults dynamically and fail safely under all circumstances. All products designed to incorporate a component part manufactured by YASKAWA must be supplied to the end user with appropriate warnings and instructions as to that part's safe use and operation. Any warnings provided by YASKAWA must be promptly provided to the end user. YASKAWA offers an express warranty only as to the quality of its products in conforming to standards and specifications published in the YASKAWA manual. **NO OTHER WARRANTY, EXPRESS OR IMPLIED, IS OFFERED.** YASKAWA assumes no liability for any personal injury, property damage, losses, or claims arising from misapplication of its products.

WARNING

- Read and understand this manual before installing, operating, or servicing this Drive. All warnings, cautions, and instructions must be followed. All activity must be performed by qualified personnel. The Drive must be installed according to this manual and local codes.
- Do not connect or disconnect wiring while the power is on. Do not remove covers or touch circuit boards while the power is on. Do not remove or insert the digital operator while power is on.
- Before servicing, disconnect all power to the equipment. The internal capacitor remains charged even after the power supply is turned off. Status indicator LEDs and Digital Operator display will be extinguished when the DC bus voltage is below 50 VDC. To prevent electric shock, wait at least five minutes after all indicators are OFF and measure DC bus voltage level to confirm safe level.
- Do not perform a withstand voltage test on any part of the unit. This equipment uses sensitive devices and may be damaged by high voltage.
- The Drive is not suitable for circuits capable of delivering more than the specified RMS symmetrical amperes. Install adequate branch short circuit protection per applicable codes. Refer to the specification. Failure to do so may result in equipment damage and/or personal injury.
- Do not connect unapproved LC or RC interference suppression filters, capacitors, or overvoltage protection devices to the output of the Drive. These devices may generate peak currents that exceed Drive specifications.
- To avoid unnecessary fault displays caused by contactors or output switches placed between Drive and motor, auxiliary contacts must be properly integrated into the control logic circuit.
- YASKAWA is not responsible for any modification of the product made by the user; doing so will void the warranty. This product must not be modified.
- Verify that the rated voltage of the Drive matches the voltage of the incoming power supply before applying power.
- To meet CE directives, proper line filters and proper installation are required.



- Some drawings in this manual may be shown with protective covers or shields removed, to describe details. These must be replaced before operation.
- Observe electrostatic discharge procedures when handling circuit cards to prevent ESD damage.
- The equipment may start unexpectedly upon application of power. Clear all personnel from the drive, motor, and machine area before applying power. Secure covers, couplings, shaft keys, and machine loads before energizing the Drive.
- Please do not connect or operate any equipment with visible damage or missing parts. The operating company is responsible for any injuries or equipment damage resulting from failure to heed the warnings in this manual.

■ Intended Use

Drives are intended for installation in electrical systems or machinery.

For use in the European Union, the installation in machinery and systems must conform to the following product standards of the Low Voltage Directive:

EN 50178, 1997-10, Equipping of Power Systems with Electronic Devices

EN 60201-1, 1997-12 Machine Safety and Equipping with Electrical Devices

Part 1: General Requirements (IEC 60204-1:1997)/

EN 61010, 1997-11 Safety Requirements for Information Technology Equipment

(IEC 950:1991 + A1:1992 + A2:1993 + A3:1995 + A4:1996, modified)

■ Other

The E7 Drive is suitable for use on a circuit capable of delivering not more than 100,000 RMS symmetrical amperes, 240Vac maximum (240V Class) and 480Vac maximum (480V Class).

Introduction

This Section describes the applicability of the Manual

The E7 Drive is a Pulse Width Modulated Drive for 3-Phase AC induction motors. This type of Drive is also known as an Adjustable Frequency Drive, Variable Frequency Drive, AC Drive, AFD, ASD, VFD, and Inverter. In this manual, the E7 Drive will be referred to as the “Drive”.

The E7 Drive is a variable torque AC drive, designed specifically for HVAC applications in building automation, including fans, blowers and pumps. A new benchmark for size, cost, performance, benefits, and quality, the E7 includes numerous built-in features such as network communications, H/O/A, PI, parameter storage and copy functions.

The E7 has embedded communications for the popular building automation protocols, Johnson Controls Metasys[®] and Siemens APOGEE[™] FLN, as well as Modbus[®]. An optional LONWORKS[®] interface card is also available.

The LCD keypad/operator is equipped with Hand/Off/Auto functions, copy feature, 7 language choices, and 5 lines of display with 16 characters per line. User parameter settings can be recovered at any time via “user initialization”. Optional software allows upload/download, as well as graphing and monitoring of drive parameters from a PC for ease of drive management.

Built-in PI control eliminates the need for closed loop output signals from a building automation system. It includes feedback display, inverse, square root and differential control functions, and maintains setpoint for closed loop control of fans and pumps for pressure, flow, or temperature regulation.

This manual is applicable to E7 Drives defined by model numbers of CIMR-E7U_ _ _ _ . This manual reflects the software version 3020.

This manual is subject to change as product improvements occur. The latest version of the manual can be obtained from the Yaskawa website www.drives.com . The date shown on the rear cover is changed when revisions are made. The latest version of Drive software is also shown.

This manual may describe trademarked equipment, which is the property of other companies. These trademarks are the property of the registered owner companies and may include the following:

APOGEE™ FLN, trademark of Siemens Building Technologies, Inc.

Metasys®, trademark of Johnson Controls Inc.

Modbus®, trademark of Schneider Automation, Inc.

LONWORKS®, trademark of Echelon Corporation

Other Documents and Manuals are available to support special use or installation of this product. These documents may be provided with the product or upon request. Contact Yaskawa Electric America, Inc. as required. Documents may include the following:

TM.E7.01.Users... Manual included on CD ROM with product

TM.E7.11.Modbus... Manual included on CD ROM with product

TM.E7.20.LONWORKS... Manual included on CD ROM with product

TM.E7.21.APOGEE ... Manual included on CD ROM with product

TM. E7.22. Metasys... Manual included on CD ROM with product

TM.E7B.01. Bypass... This manual should be used when the E7 Drive is packaged with Bypass Control

DriveWizard ... Software and Manual...Included on CD ROM with product

Option Instructions... Included on CD ROM with product

Programming

This Manual contains descriptions of all user accessible parameters contained in the Drive. Parameters are listed in alpha-numerical order. Parameter number and name, along with a detailed description and its settings are described on the following pages.

A1 Initialization.....	2
A2 User Parameters	4
b1 Sequence.....	4
b2 DC Braking	10
b3 Speed Search	12
b4 Delay Timers.....	15
b5 PI Function.....	16
b8 Energy Savings Selection	25
C1 Accel/Decel	26
C2 S-Curve Acc/Dec.....	28
C4 Torque Comp.....	29
d1 Preset References	32
d2 Reference Limits	34
d3 Jump Frequencies	35
d4 Sequence.....	36
E1 V/f Pattern	37
E2 Motor Setup.....	43
F6 Com OPT Selection	44
H1 Digital Inputs.....	45
H2 Digital Outputs.....	63
H3 Analog Inputs	70
H4 Analog Outputs	78
H5 Serial Communications Setup.....	83
Modbus Function Code Details.....	88
L1 Motor Overload	99
L2 Momentary Power Loss Function	103
L3 Stall Prevention.....	104
L4 Speed Command Loss Detection	108
L5 Fault Restart	109
L6 Torque Detection.....	111
L8 Hardware Protection	113
N1 Hunting Prevention.....	117
N3 High Slip Braking.....	118
O1 Monitor Configuration.....	120
O2 Key Selections	124
O3 Digital Operator Copy Function.....	130
T1 Auto-Tuning	133
Appendix A - Parameter List.....	A-1
Appendix B - Factory Default Settings	B-1

E7 Basic Programming Parameters

The initialization group contains parameters associated with initial set-up of the Drive. Parameters involving the display language, access levels, initialization and password are located in this group.

◆ A1 Initialization

■ A1-00 Select Language

Setting	Description
0	English (<i>factory default</i>)
1	Japanese
2	Deutsch
3	Francais
4	Italiano
5	Espanol
6	Portugues

The setting of parameter A1-00 determines which international language the Drive will use to display non-numerical text. The A1-00 parameter will not be changed by an Initialization of the drive (A1-03= “1110: User Initialize”, “2220: 2-Wire Initial”, or “3330: 3-Wire Initial”).

If the Drive is accidentally set to a language unfamiliar to the operator, locating the parameter to change the operator language can be done by performing the following:

1. Press the MENU key until the “-ADV-” MENU is shown in the upper left corner of the digital operator.
2. Press the DATA/ENTER key to enter the programming menu. The first parameter shown is A1-00 (Select Language).
3. Press the DATA/ENTER key again and use the INCREASE and DECREASE arrow keys to choose the preferred language from the list below:

0 : English
1 : Japanese
2 : Deutsch (German)
3 : Francais (French)
4 : Italiano (Italian)
5 : Español (Spanish)
6 : Portugu s (Portuguese)

■ A1-01 Access Level Selection

Setting	Description
0	Operation Only
1	User Level
2	Advanced Level (<i>factory default</i>)

A1-01 can be used to allow access to and permission to change all Drive parameters. If the Drive is programmed for Operation Only (A1-01= “0: Operation Only”), then only the OPERATION and the PROGRAMMING menus are accessible. Within the PROGRAMMING menu only parameters A1-01 and A1-04 are adjustable.

If A1-01 is configured for Advanced Access (A1-01= “2: Advanced Level”), then all menus and all parameters are shown. If the Access Level Selection is set to Advanced, all parameters should be adjustable unless:

1. The Drive parameters are password protected (A1-04) which will prevent access to A1-00 through A1-03 and all A2 parameters.
2. A digital input has been configured as a Program Lockout (H1-0X= 1B) is active.
3. During serial communication writing, if a parameter change is also attempted via the digital operator, a “BUSY - WRITE PROTECTED” message will display. Parameter change will not be possible from the digital operator until an Enter command is received via the serial communication to finish the serial writing process.

■ A1-03 Initialize Parameters

Setting	Description
0	No Initialize (<i>factory default</i>)
1110	User Initialize
2220	2-Wire Initialize
3330	3-Wire Initialize

The Drive can be set back to one of three default states via the A1-03 parameter.

1. User Initialization – 1110: The modified Drive parameters are returned to the values selected as user settings. User settings are stored when parameter o2-03= “1: Set Defaults”.
2. 2-Wire Initialization – 2220: The Drive parameters are returned to factory default values with digital inputs S1 and S2 configured as Forward Run and Reverse Run, respectively.
3. 3-Wire Initialization – 3330: The Drive parameters are returned to factory default values with digital inputs S1, S2, and S5 configured as Run, Stop, and Forward/Reverse respectively.

After an initialization is performed, parameter A1-03 will automatically be set back to 0.

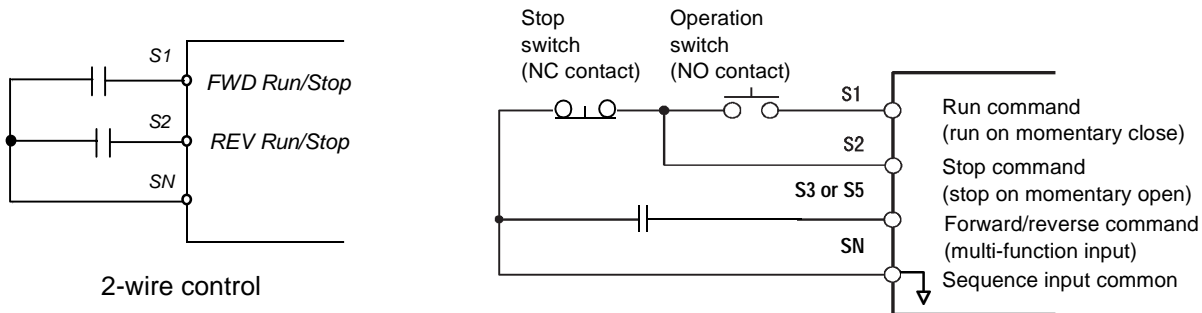

Fig. 1 2 & 3-Wire Control Wiring Examples

IMPORTANT

Some parameters are unaffected by either the 2-Wire or 3-Wire initialization. The following parameters will not be reset when parameter A1-03=2220 or 3330:

- | | |
|-------|--|
| A1-00 | Language Selection |
| E1-03 | V/f Pattern Selection |
| o2-04 | kVA Selection |
| o2-09 | Initialization Specification Selection |

■ A1-04 Password Entry

Setting Range: 0 to 9999

Factory Default: 0

If parameters A1-01 through A1-03 and all of the A2 parameters are locked (unchangeable) they can be unlocked by entering the correct password number into A1-04.

Once the correct password number is entered and the specified parameters are unlocked, a 2-Wire or 3-Wire initialization will reset the password to 0000.

■ A1-05 Select Password

Setting Range: 0 to 9999

Factory Default: 0

When the value set into A1-04 does NOT match the value set into A1-05, parameters A1-01 thru A1-03 and A2-32 cannot be changed. All other parameters determined by A1-01 can be changed. Parameter A1-05 can be accessed by displaying parameter A1-04, then press and hold the RESET key along with the MENU key simultaneously.

◆ A2 User Parameters

■ A2-01 - A2-32 User Parameter

Setting Range: b1-01 to o3-02

Factory Default: <none>

The Drive can be programmed to select up to 32 parameters for limited-access programming. By setting the Access Level to User Level (A1-01= "1: User Level"), only the parameters entered into parameters A2-01 through A2-32 can be accessed and modified by the user.

Parameter A1-01 must first be set to 2 (Advanced Access Level) in order to program the A2 parameters to the desired user parameters. Once the A2 parameters are programmed, A1-01 should be set to 1(User Access Level) to prevent the user from changing any parameters except the A1 parameters and the parameters specified in A2-01 through A2-32.

◆ b1 Sequence

The Sequence Group contains parameters associated with starting and stopping the Drive. Parameters involving the Run Command, Speed Reference location, Stopping Method and Hand/Auto changeover are located in this group.

■ b1-01 Reference (Speed Command) Source Selection

Setting	Description
0	Operator - Digital Preset Speed d1-01
1	Terminals - Analog Input Terminal A1 (or Terminal A2, see Parameter H3-13)
2	Serial Com - RS-485 Terminals R+, R-, S+ and S-
3	Option PCB - Option Board connected at 2CN

In order to run the Drive and motor, the Drive must receive a Run command and a speed command. Parameter b1-01 specifies from where the speed command is received when in the “Auto mode. Switching into the “Auto” mode can be done by pressing the AUTO button on the digital operator while the Drive is stopped.

IMPORTANT

If a Run command is input to the Drive but no corresponding speed command is input, the Run indicator on the digital operator will turn on and the STOP indicator on the digital operator will blink.

If you want the Drive to follow the speed command set by the digital operator: Use the “Hand” mode by pressing the hand key or set b1-01= “0: Operator”. The speed command can then be entered into the U1-01 monitor parameter in the “-DRIVE-” Menu.

If you want the Drive to follow an “Auto” analog speed command: Set b1-01= “1: Terminals”, and connect a 0 – 10 Vdc speed command signal between terminals A1 and AC or a 4 – 20 mA speed command signal to terminals A2 and AC.

If you want the Drive to receive the speed command from serial communication: Set b1-01= “2: Serial Com”, and connect the RS-485/422 serial communications cable to terminals R+, R-, S+, and S- on the control I/O terminal block.

If you want to use LONWORKS® to input a speed command: Set b1-01= “3: Option PCB”, and plug a LONWORKS® option board (p/n SI-J) into the 2CN port on the Drive Control PCB. Consult the manual supplied with the option board for instructions on integrating the Drive into the LONWORKS® System.

IMPORTANT

If b1-01= “3: Option PCB” but a LONWORKS® card is not installed in 2CN, an OPE05 Operator Programming Error will be displayed on the digital operator and the Drive will not run.

■ **b1-02 Run Source**

Setting	Description
0	Operator
1	Terminals <i>(factory default)</i>
2	Serial Com
3	Option PCB

To successfully operate the Drive remotely, an external run command must be received by the Drive. Parameter b1-02 specifies from where the run command will be accepted.

Although the Run Source and the Reference Source (b1-01) are normally taken from the same source (e.g. digital operator, terminals or serial communication), this is not always the case.

To issue a run command from the digital operator: Set b1-02= “0: Operator”, and use the HAND and OFF buttons to start and stop the Drive.

To issue the run command from the terminals: Set b1-02= “1: Terminals”, and select between 2-wire and 3-wire control operation by doing the following:

2-Wire Control The factory default setting is for 2-wire operation. In the 2-wire configuration a closure between S1 and SN will be interpreted as a Forward Run command by the Drive. A closure between S2 and SN will be interpreted as a Reverse Run command. If both S1 and S2 are closed, the Drive will stop (decelerate to zero speed) and the digital operator will display

an EF (external fault) alarm (Flashing).

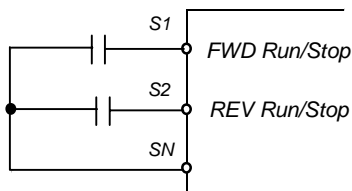

Fig. 2 2-Wire Control

3-Wire Control When any of the multi-function digital input parameters, H1-01 through H1-05, is set to 0, terminals S1 and S2 become Run and Stop, respectively. The multi-function digital input that was set to 0 will function as a Forward/Reverse input for the Drive. When the Forward/Reverse input is open the Drive will run in the Forward direction and when the input is closed, the Drive will run in the Reverse direction.

In 3-wire operation a momentary closure (> 50mS) of S1 will cause the Drive to run provided that S2 is held closed. The Drive will stop anytime the S2-SN connection is broken. If the 3-wire configuration is implemented via a 3-wire Initialization (A1-03= “3330: 3-Wire Initial”), then terminal S3 becomes the Forward/Reverse input.

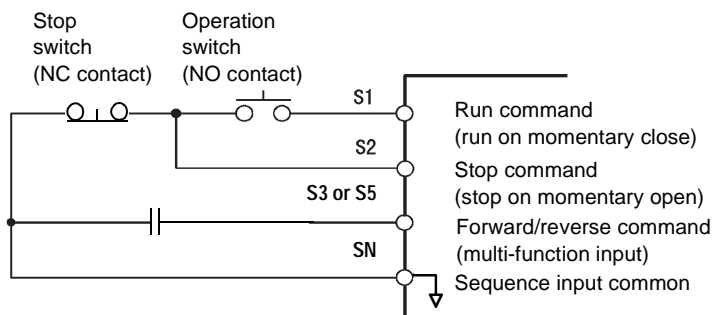

Fig. 3 3-Wire Control

To issue a run command via serial communication: Set b1-02= “2: Serial Com” and connect the RS-485/422 serial communication cable to R+, R-, S+, and S- on the removable terminal block.

To issue the Run command via the LONWORKS® option card: Set b1-02= “3: Option PCB”, and plug a LONWORKS® option board (p/n SI/I) into the 2CN port on the Control PCB. Consult the manual supplied with the option board for instructions on integrating the Drive into your LONWORKS® System.

IMPORTANT If b1-01= “3: Option PCB” but a LONWORKS® card is not installed in 2CN, an “OPE05” operator programming error will be displayed on the digital operator and the Drive will not run.

■ **b1-03 Stopping Method**

There are four methods of stopping the Drive when the Run command is removed.

Setting	Description
0	Ramp to Stop (<i>factory default</i>)
1	Coast to Stop
2	DC Injection to Stop
3	Coast w/Timer

“0:Ramp to stop”: When the Run command is removed, the Drive will decelerate the motor to 0 rpm. The rate of

deceleration is determined by the active deceleration time. The factory default Decel Time is in parameter C1-02.

When the output frequency has dropped below the DC Injection Start Frequency in b2-01 (Default = 0.5HZ) DC current will be injected in the motor at a level determined by b2-02 (50% Default). The DC Injection condition will occur for the time specified by b2-04 (0.0 Default), to establish the end point of the ramp. DC injection can be used to insure the motor is at zero rpm prior to the Drive shutting off.

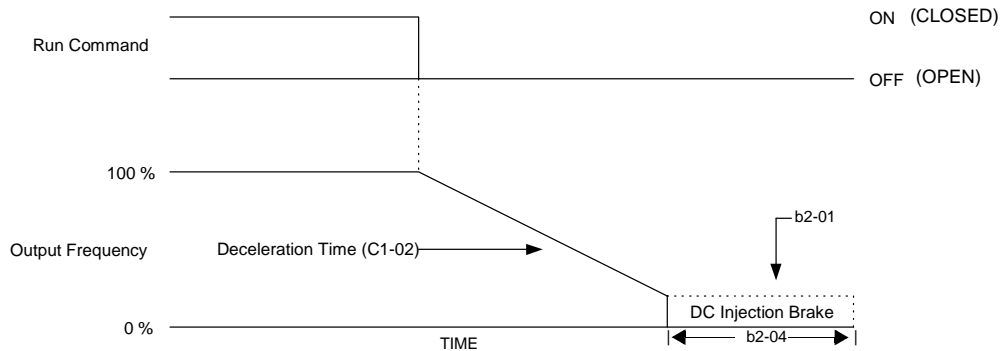

Fig. 4 Deceleration to Stop

The actual deceleration time can be determined by the following formula

$$\text{Time to Stop} = \frac{\text{Output Freq. at time of stop command}}{\text{Maximum Frequency (E1 - 04)}} \times \text{Setting of active Decel Time (C1 - 02 or C1-04)}$$

If S-Curve characteristics are specified by the Drive programming, they will add to the total time to stop.

“1:Coast to stop”: When the Run command is removed, the Drive will turn off its output and the motor will coast (uncontrolled deceleration). The friction of the driven equipment will eventually overcome any residual inertia of the system and the rotation will stop.

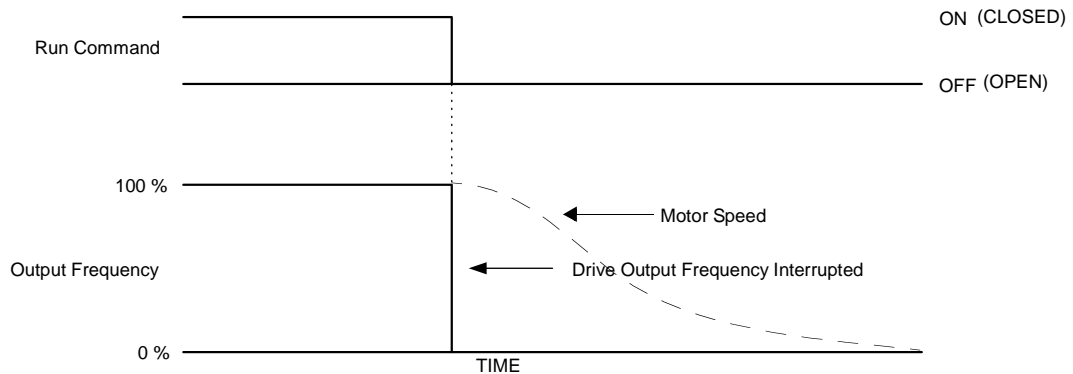

Fig. 5 Coast to Stop

IMPORTANT

After a stop is initiated, a subsequent Run commands input before the Minimum Baseblock Time (L2-03) has expired, will be ignored.

2: DCInj to Stop: When the Run command is removed, the Drive will Baseblock (turn off its output) for the Minimum Baseblock Time (L2-03). Once the Minimum Baseblock Time has expired, the Drive will inject DC current into the motor windings to lock the motor shaft. The stopping time will be reduced as compared to Coast to Stop. The level of DC Injection current is set by parameter b2-02 (50% Default). The DC Injection brake time is determined by the set value in b2-04 and the output frequency at the time the Run command is removed.

$$\text{DC Injection Brake Time} = \frac{(b2 - 04) \times 10 \times \text{Output Frequency}}{\text{Maximum Frequency (E1 - 04)}}$$

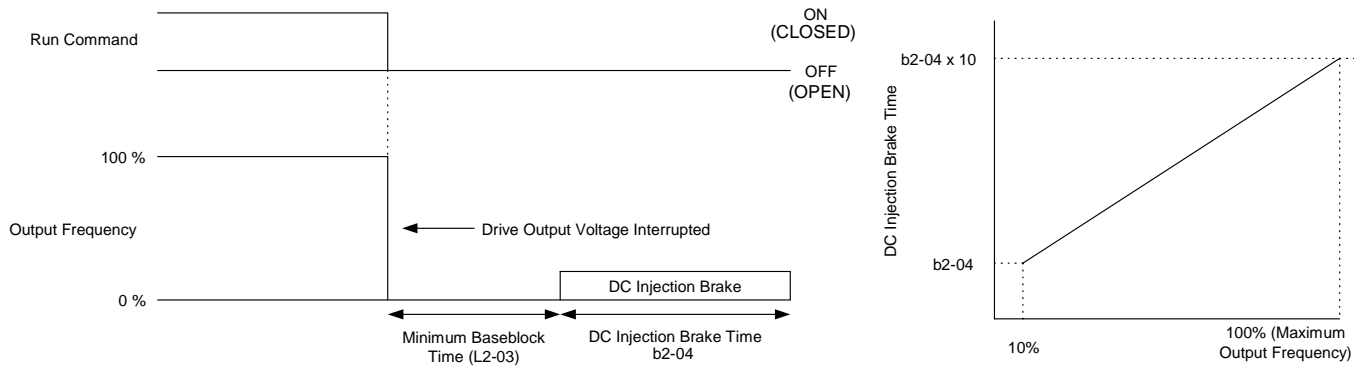

Fig. 6 DC Injection Braking to Stop

IMPORTANT

If an overcurrent (OC) fault occurs during DCInj to Stop, lengthen the Minimum Baseblock Time (L2-03) until the fault no longer occurs.

3: Coast w/Timer: When the Run command is removed, the Drive will turn off its output and the motor will coast to a stop. If a Run command is input before time T (operation wait time) expires, the Drive will not run and the Run command will need to be cycled before operation can occur. The time T (operation wait time) is determined by the output frequency when the Run command is removed and the active deceleration time (C1-02).

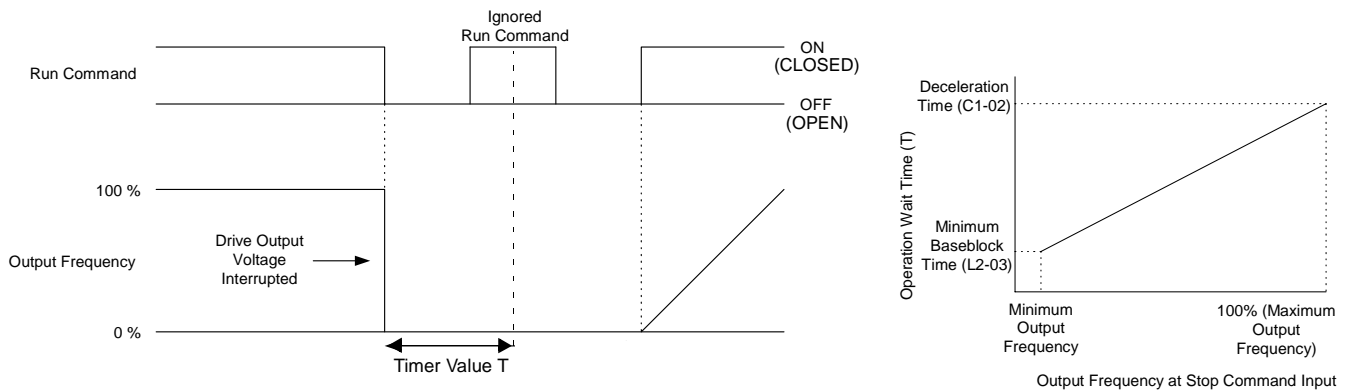

Fig. 7 Coast to Stop with Timer

■ b1-04 Reverse Operation

Setting	Description
0	Reverse Enabled
1	Reverse Disabled (<i>factory default</i>)
2	Exchange Phase
3	ExchgPhs, Rev Dsbl

For some applications reverse motor rotation is not applicable and may even cause problems (e.g., air handling units, pumps, etc.). Setting parameter b1-04 to 1 or 3 will cause the Drive to ignore any inputs for reverse operation. Setting parameter b1-04 to either 2 or 3 will change the motor shaft rotation when a Forward Run command is given by exchanging the order of the output phasing.

The factory default setting of parameter b1-04 is “1: Disabled”. When b1-04= “1: Disabled”, reverse operation is prohibited and no exchanging of output phasing occurs.

Drive terminal S2 is a dedicated input for reverse Run/Stop.

■ b1-07 Local/Remote Run Selection

Setting	Description
0	Cycle Extern Run (<i>factory default</i>)
1	Accept Extrn Run

When the Drive is switched between the Local (Hand) mode (the digital operator) to the Remote (Auto) mode (determined by b1-01 and b1-02), there is the possibility that a Run command is already present (i.e. a contact closure between S1 and SN when b1-02= “1: Terminals”). Parameter b1-07 determines whether the Drive will:

Ignore the external Run command until it is removed and re-instated (b1-07= “0: Cycle Extern Run”)

OR

Accept the already present Run command and immediately begin acceleration to the commanded speed (b1-07= “1: Accept Extrn Run”).

IMPORTANT

When switching from local mode to Auto mode when b1-07=“1: Accept Extrn Run” the Drive may start unexpectedly if the Run command is already applied. Be sure all personnel are clear of rotating machinery and electrical connections prior to switching between local mode and Auto mode.

■ b1-08 Run Command Selection During Programming

Setting	Description
0	Disabled (<i>factory default</i>)
1	Enabled

As a safety precaution, the Drive will not normally respond to a Run input when the digital operator is being used to adjust parameters. If it is necessary that external Run commands be recognized even while the Drive is being programmed, set b1-08= “1: Enabled”.

■ b1-11 Drive Delay Time Setting

Setting Range: 0 to 600 Seconds

Factory Default: 0 Seconds

If a time is set into parameter b1-11, the Drive will delay executing any run command until the b1-11 time has expired. During Drive delay time execution, the digital operator will display:

DDL
Waiting to RUN

Both the ALARM and Run indicators will blink while the Drive waits to execute the Run command.

■ b1-12 Hand Frequency Reference Selection

Setting	Description
0	Operator (<i>factory default</i>)
1	Terminals

When the Drive is put into the HAND mode, by pressing the HAND key while in Operation, the Speed Command will be set via the digital operator by default. If it is desirable to have the Speed Command input from the terminals instead of the digital operator, set b1-12= “1: Terminals”.

IMPORTANT

When the Speed Command is set via the terminals, parameter H3-13 will determine whether analog input terminal A1 or A2 is the Speed Command.

◆ b2 DC Braking

The DC Braking Group contains parameters associated with the DC injection braking feature. Parameters involving the starting frequency, current level, braking time, and motor pre heat current level are located here.

■ b2-01 DC Injection Braking Start Frequency

Setting Range: 0.0 to 10.0 Hz

Factory Default: 0.5 Hz

Parameter b2-01 sets the output frequency where the Drive begins DC Injection during Ramp to stop, in order to lock the rotor of the motor and established the end point of the ramp. If b2-01 < E1-09 (Minimum Frequency), then DC Injection begins at E1-09.

Parameter b2-01 also determines the output frequency that the Drive must be at or below before a Zero Speed condition is considered true. This affects any digital output configured as a Zero Speed signal (H2-0x= “1: Zero Speed”).

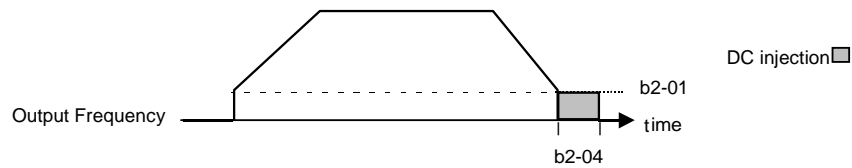

Fig. 8 DC Injection Braking During Stopping

■ b2-02 DC Injection Braking Current

Setting Range: 0 to 100%

Factory Default: 50%

The level of DC Injection Braking Current affects the strength of the magnetic field attempting to lock the motor shaft. Increasing the level of current will increase the amount of heat generated by the motor windings and should only be increased to the level necessary to hold the motor shaft. DC Injection current is set in percentage of Drive rated output current. Drive rated output current is stated on the Drive nameplate.

■ b2-03 DC Injection Braking Time at Start

b2-04 DC Injection Braking Time at Stop

Setting Range: 0.00 to 10.00 Seconds

Factory Default: 0.00 Seconds

The Drive can be programmed to automatically DC Inject for a predetermined amount of time prior to accelerating to speed (b2-03) and/or at the end of a Ramp to stop (b2-04). Parameter b2-03 can be used to stop a rotating motor prior to attempting acceleration (i.e. a wind milling fan). If DC Injection braking at start or Speed Search is not enabled, attempting to drive a spinning motor may cause nuisance tripping.

Parameter b2-04 can be used to resist any residual motion of the load after the deceleration has finished.

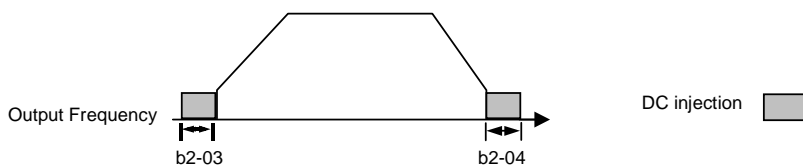

Fig. 9 DC Injection Braking During Starting and Stopping

Parameter b2-04 also serves the function of affecting the length of time DC Injection to stop (b1-03= “2: DC Injection to Stop”) will occur.

■ b2-09 Motor Pre-Heat Current

Setting Range: 0 to 100%

Factory Default: 0%

A DC current can be circulated within the motor windings while the motor is stopped. The current will produce heat within the motor and prevent condensation. Parameter b2-09 determines the percentage of Drive rated output current that will be used for the motor pre-heat function. This function can be useful in applications where the motor sits for extended periods of time in humid conditions. Motor pre-heating can only be initiated by closing a digital input programmed as a Motor Pre-heat Input (H1-0x= 60). Check with the motor manufacturer to determine the maximum acceptable current level the motor can withstand when stopped. Be sure not to exceed the motor manufacturers recommended level.

◆ b3 Speed Search

The Speed Search function allows the Drive to determine the speed of a motor shaft that is being driven by rotational inertia. Speed Search will allow the Drive to determine the speed of the already rotating motor and begin to ramp the motor to a set speed without first having to bring it to a complete stop. When a momentary loss of supply power is experienced, the Drive output is turned off. This results in a coasting motor. When power returns, the Drive can determine the speed of the coasting motor and start without requiring it to be brought to minimum speed. Speed Search can be programmed to always be active by setting b3-01 or it can be commanded by remote contact closure by setting a digital input.

There are two forms of Speed Search in the Drive, the speed estimation method and the current detection method.

IMPORTANT

When setting the Drive for remote Speed Search input, via a contact closure, the method of Speed Search is determined by the setting of b3-01. If b3-01= "0: SpdsrchF Disable" then the remote input will initiate speed estimation method, and if b3-01= "2: SpdsrchI Disable", then the remote input will start the current detection method.

Parameters L2-03 and L2-04 also affect the current detection method of Speed Search operation.

■ b3-01 Speed Search Selection

This parameter is effective only when the Drive is given a new "RUN" command.

Setting	Description
0	SpdsrchF Disable
1	SpdsrchF Enable
2	SpdsrchI Disable (<i>factory default</i>)
3	SpdsrchI Enable

Speed Estimation: Method (b3-01= 0 or 1) The speed estimation method will calculate the speed using measurements of residual motor fields. The speed estimation version is bi-directional and will determine both the motor speed and direction. To enable speed estimation Speed Search at start, set b3-01= "1: SpdsrchF Enable".

IMPORTANT

If the speed estimation method of Speed Search is to be used, then Auto-tuning must be performed prior to using Speed Search. If the length of cable between the Drive and motor is ever changed after Auto-tuning then Auto-tuning should be performed again.

IMPORTANT

The speed estimation mode cannot be used when there are multiple motors operated by one Drive or the motor is two or more frames smaller than the standard size motor per the Drive capacity.

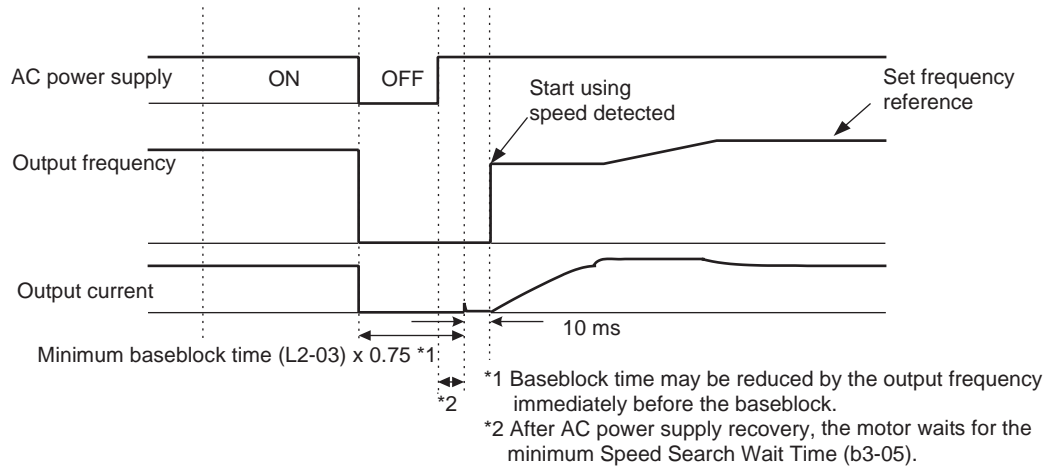
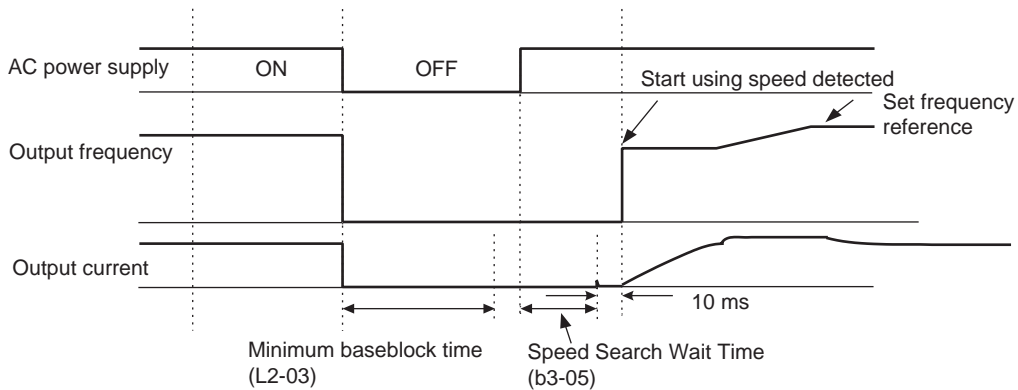

Fig. 10 Speed Search (Estimated Speed Method) after momentary power loss where the power loss time is less than the minimum baseblock time



Note: If the frequency immediately before the baseblock is low or the power supply off time is long, operation may be the same as the search in case 1.

Fig. 11 Speed Search (Estimated Speed Method) after momentary power loss where the power loss time exceeds the minimum baseblock time

Current Detection Method (b3-01=2 or 3): The current detection method starts searching from a predetermined frequency while monitoring the Drive output current to determine when the rotor speed and the Drive output speed (frequency) match. The current detection version is not bi-directional. To enable current detection Speed Search at start set b3-01= “3: SpdschrI enable” and program any digital input equal to Speed Search 1 (H1-0x= 61) or Speed Search 2 (H1-0x= 62). Speed Search 1 will start searching from the max. frequency (E1-04) and ramp down to meet the rotor speed. Speed Search 2 will start searching from the set frequency and ramp down to meet the rotor speed.

IMPORTANT

If a UV1 fault occurs when current detection Speed Search is attempted, increase the setting of L2-04

IMPORTANT | If an OC fault occurs when Speed Search is attempted after power loss recovery, increase the setting of L2-03.

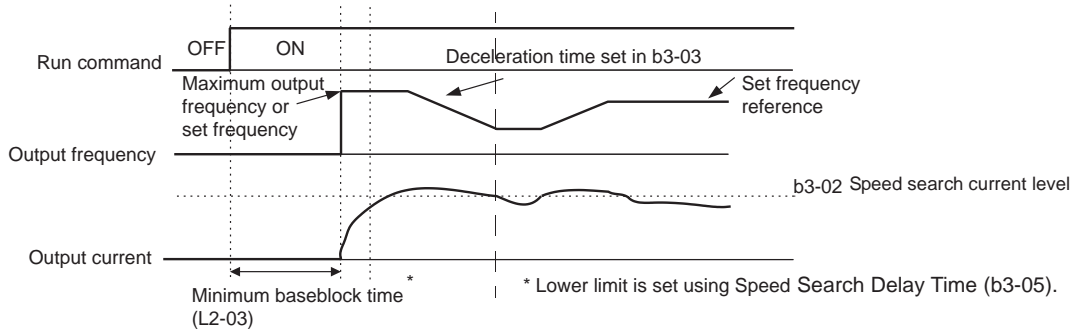

Fig. 12 Speed Search (Current Detection Method) at Startup

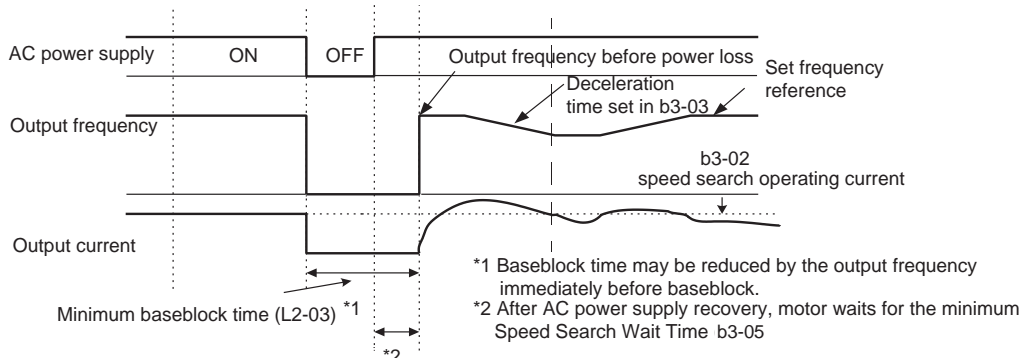

Fig. 13 Speed Search (Current Detection Method) after momentary power loss where the power loss time is less than the minimum baseblock time

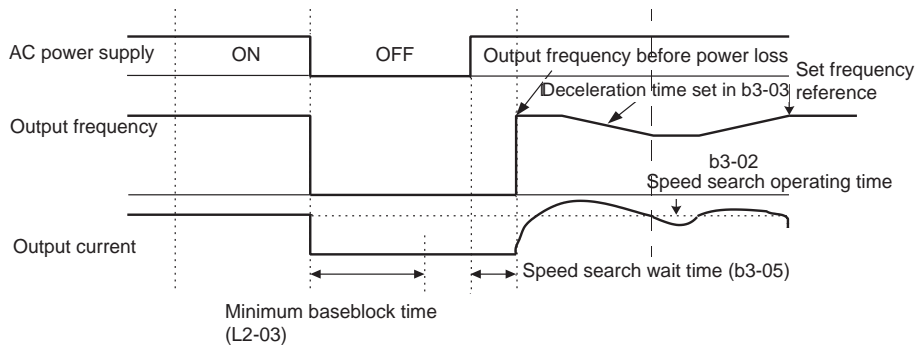

Fig. 14 Speed Search (Current Detection Method) after momentary power loss where the power loss time exceeds the minimum baseblock time

Setting of b3-01	Automatic Speed Search for all RUN commands	Automatic Speed Search after momentary power loss and baseblock	Speed Search Used for Run with programmed multi-function input
0	No	Yes - Speed Estimation	Yes - Speed Estimation
1	Yes - Speed Estimation	Yes - Speed Estimation	Yes - Speed Estimation
2	No	Yes - Current Detection	Yes - Current Detection
3	Yes - Current Detection	Yes - Current Detection	Yes - Current Detection

■ b3-02 Speed Search Deactivation Current

Setting Range: 0 to 200% of Drive rated output current

Factory Default: 120% of Drive rated output current

When using the current detection method of Speed Search, parameter b3-02 sets the current level that will determine when the search is complete and the rotor and output speeds match. When the output frequency is higher than the actual rotor speed the slip causes the current to be high. As the output frequency is lowered, the closer it comes to the rotor speed, the lower the current draw will be. When the output current drops below the level as set in b3-02 (100% = Drive Rated Current) the output frequency stops decreasing and normal operation resumes.

■ b3-03 Speed Search Deceleration Time

Setting Range: 0.1 to 10.0 Seconds

Factory Default: 2.0 Seconds

Parameter b3-03 sets the deceleration ramp used by the current detection method of Speed Search when searching for the motor's rotor speed. Even if Speed Search 2 is selected, for Speed Search at start, the time entered into b3-03 will be the time to decelerate from maximum frequency (E1-04) to minimum frequency (E1-09).

■ b3-05 Speed Search Delay Time

Setting Range: 0.0 to 20.0 Seconds

Factory Default: 0.2 Seconds

In cases where an output contactor is used between the Drive and the motor, extra waiting time is provided after power returns and before Speed Search is performed. This extra time allows for the contactor to operate. When Speed Search at start is used, b3-05 will serve as the lower limit of the Minimum Baseblock Time (L2-03).

■ b3-14 Bi-Directional Speed Search Selection

Setting	Description
0	Disabled
1	Enabled (<i>factory default</i>)

The b3-14 parameter can be used to turn off the bi-directional capabilities of the Speed Estimation form of Speed Search. By turning off the bi-directional capability, the speed search will only try to match the speed in the last known direction.

◆ b4 Delay Timers

The Drive has an internal timer function that operates independently from the Drive. A digital input must be programmed to be a timer start input by setting H1-0x= 18. A digital output must be programmed as a timer output by setting H2-0x= 12. (Not to be confused with the "Wait to Run Time" in b1-11)

■ b4-01 Timer Function ON-Delay Time

Setting Range: 0.0 to 3000.0 Seconds

Factory Default: 0.0 Seconds

The timer start input (H1-0x= 18) must be held on for at least the time specified in parameter b4-01 before the digital output programmed as the timer output will close. See Figure on following page for timing details.

■ b4-02 Timer Function OFF-Delay Time

Setting Range: 0.0 to 3000.0 Seconds

Factory Default: 0.0 Seconds

The timer start input (H1-0x= 18) must be held off for at least the time specified by b4-02 before the digital output programmed as the timer output will open. See Figure below for timing details.

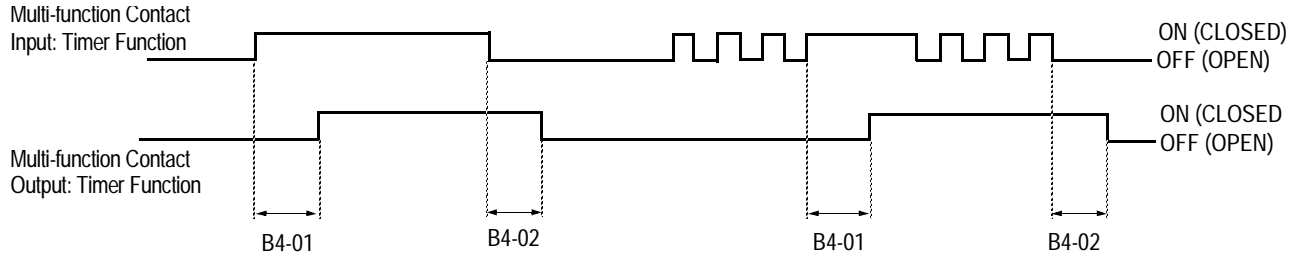

Fig. 15 Timing Diagram of Timer Function

◆ b5 PI Function

The capability to accept an analog signal as feedback for a PI (Proportional + Integral) control function is built into the Drive.

Speed Command / PI Setpoint

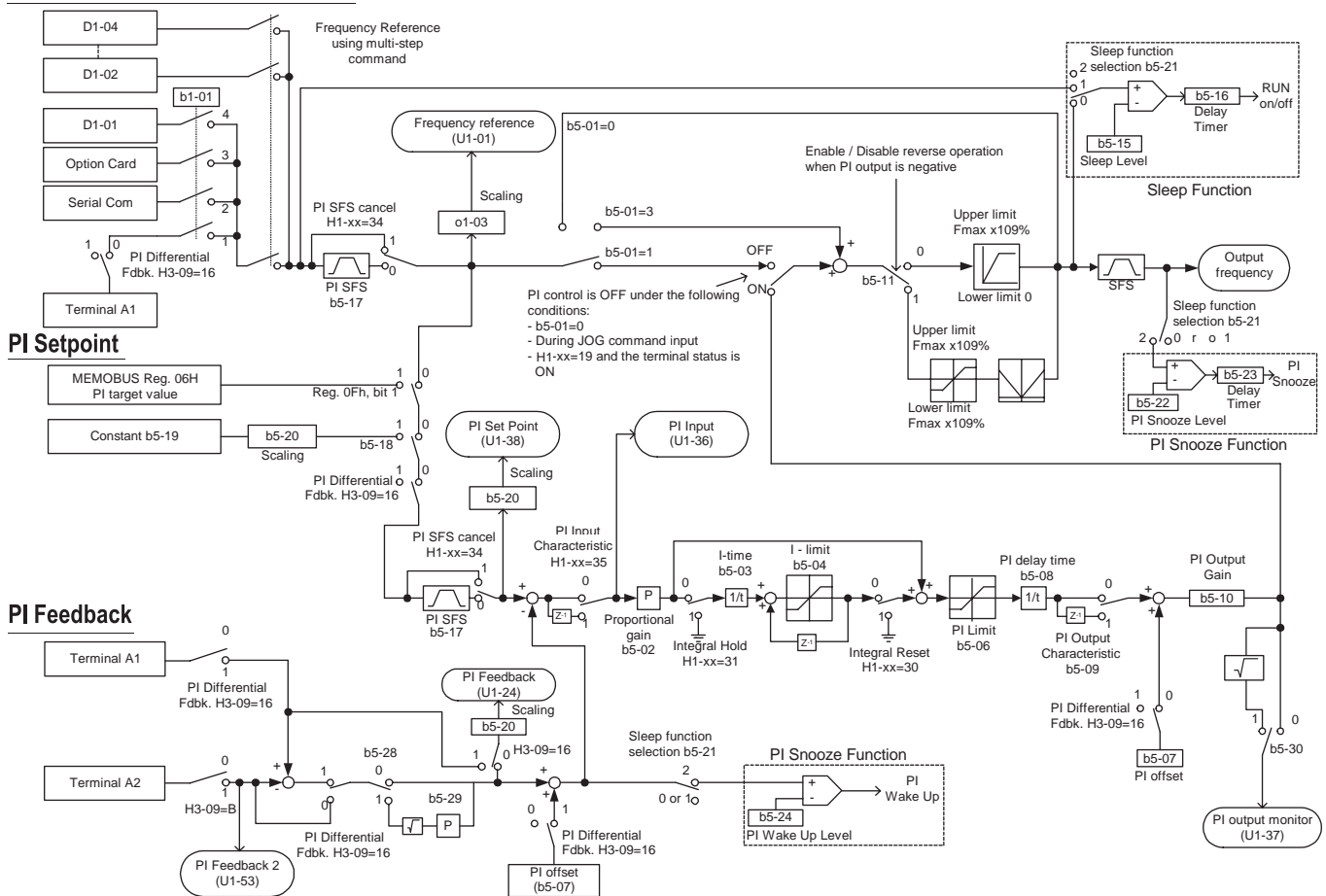

Fig. 16 PI Block Diagram

The analog feedback to the Drive for the PI control is via the A2 terminal. The Drive must be programmed (H3-09= “B: PI Feedback”) to use terminal A2 as feedback for the PI functionality of the Drive.

The PI setpoint can be configured to come from one of many different inputs or parameters. The table below describes the options for originating the PI setpoint.

Table 1 PI Setpoint Options			
The PI Setpoint will be read from:	If these conditions are true		
	Status of b5-18	Status of Modbus Register 0Fh bit 1	Status of b1-01
Parameter b5-19	= 1	N/A	N/A
Modbus Register 06H	= 0	ON	N/A
D1-01	= 0	OFF	= 0
Terminal A1	= 0	OFF	= 1
Serial Comm.	= 0	OFF	= 2
Option PCB	= 0	OFF	= 3

In some situations there are two feedback inputs. The drive can be programmed to maintain a set differential between two analog signals. If input A2 is configured as a “PI Differential Mode” (H3-09= “16: PI Differential”), then the Drive will maintain a set difference between the measurements read on inputs A1 and A2. This differential setpoint is programmed by parameter (b5-07).

■ b5-01 PI Mode

Setting	Description
0	Disabled (<i>factory default</i>)
1	Enabled
3	Fref+PI

The Drive can be used as a stand-alone PI controller. If PI functionality is selected by parameter b5-01, the Drive will adjust its output to cause the feedback from a transmitter to match the PI setpoint (b5-19). The setting of b5-01 will determine whether PI functionality is disabled (b5-01= “0: Disabled”), enabled (b5-01= “1: Enabled”), or enable with the output of the PI function used to trim a Speed Command (b5-01= “3: Fref+PI”).

■ b5-02 Proportional Gain Setting

Setting Range: 0.00 to 25.00

Factory Default: 2.00

The proportional gain will apply a straight multiplier to the calculated difference (error) between the PI Setpoint and the measured transmitter feedback at terminal A2. A large value will tend to reduce the error but may cause instability (oscillations) if too high. A small value may allow to much offset between the setpoint and feedback (See Figure 17 on following page).

■ b5-03 Integral Time Setting

Setting Range: 0.0 to 360.0 Seconds

Factory Default: 5.0 Seconds

The Integral factor of PI functionality is a time-based gain that can be used to eliminate the error (difference between the setpoint and feedback at steady state). The smaller the Integral Time set into b5-03, the more aggressive the Integral factor will be. To turn off the Integral Time, set b5-03= 0.00.

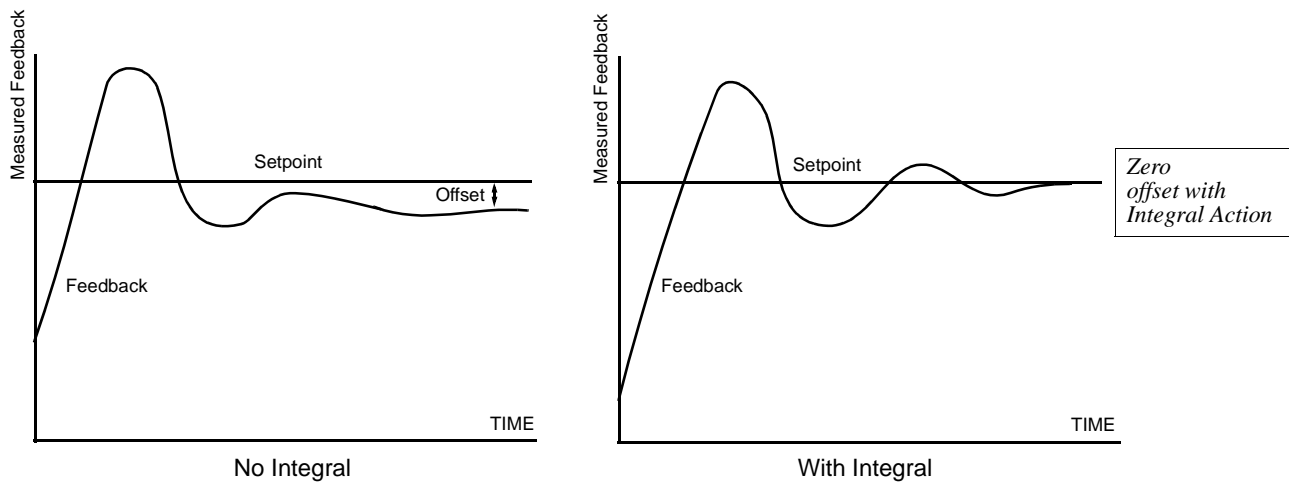

Fig. 17 PID Feedback Response Characteristics

■ b5-04 Integral Limit Setting

Setting Range: 0.0 to 100.0%

Factory Default: 100.0%

On some applications, especially those with rapidly varying loads, the output of the PI function may have large oscillations. To suppress these oscillations, a limit can be applied to the integral factor by programming b5-04.

■ b5-06 PI Output Limit

Setting Range: 0.0 to 100.0%

Factory Default: 100.0%

Places a cap on the output of the PI function. Limiting the PI function may help to prevent large overshoots in the Drive's response to error (the difference between the setpoint and the feedback).

■ b5-07 PI Offset Adjustment

Setting Range: -100.0% to +100.0%

Factory Default: 0.0%

The PI Offset Adjustment parameter has two different uses. Parameter b5-07 serves different functions depending on whether it is used on a standard PI loop or a Differential PI loop.

Parameter b5-07 causes an offset to be applied to the output of the PI function in a non-Differential PI loop. Every time the PI output is updated, the offset (b5-07) is summed with the PI output. This can be used to artificially kick-start a slow starting PI loop.

If the Drive is configured for Differential PI Regulation (H3-09= "16: PI differential"), then this parameter is the target setpoint for the differential to be maintained between the signal measured on analog input A1 and the signal measured on analog input A2.

■ b5-08 PI Primary Delay Time Constant

Setting Range: 0.00 to 10.00 Seconds

Factory Default: 0.00 Seconds

Acts as a time based filter that lowers the responsiveness of the PI function, but also makes the function more stable when the setpoint varies rapidly or when the feedback is noisy.

■ b5-09 PI Output Level Selection

Setting	Description
0	Normal Output (direct acting) (<i>factory default</i>)
1	Reverse Output (reverse acting)

Normally, the output of the PI function causes an increase in motor speed whenever the measured feedback is below the setpoint. This is referred to as direct acting response. However, if b5-09= “1: Reverse Output”, the output of the PI function causes the motor to slow down when the feedback is below the setpoint. This is referred to as reverse acting response.

■ b5-10 PI Output Gain Setting

Setting Range: 0.0 to 25.0

Factory Default: 1.0

Applies a multiplier to the output of the PI function. Using the gain can be helpful when the PI function is used to trim the Speed Command. Increasing b5-10 causes the PI function to have a greater regulating affect on the speed command.

■ b5-11 PI Reverse Selection

Setting	Description
0	0 Limit (<i>factory default</i>)
1	Reverse

Parameter b5-11 determines whether reverse operation is allowed while using PI control (b5-01≠0). The factory default setting will not allow the Drive to run in reverse. This parameter does not need to be changed from factory default for a majority of HVAC applications. (Refer also to b5-09).

■ b5-12 PI Feedback Reference Missing Detection Selection

Setting	Description
0	Disabled (<i>factory default</i>)
1	Alarm
2	Fault

Loss of feedback can cause problems to a PI application. The Drive can be programmed to turn on a digital output whenever a loss of feedback occurs. Feedback Loss Detection is turned on by b5-12. When b5-12= “1: Alarm”, the Drive acknowledges the loss of feedback without stopping or turning on the fault output (MA-MB). If b5-12= “2: Fault”, the Drive coasts to a stop and turns on the fault output if the feedback is determined to be lost.

■ b5-13 PI Feedback Loss Detection Level

Setting Range: 0 to 100%

Factory Default: 0%

■ b5-14 PI Feedback Loss Detection Time

Setting Range: 0.0 to 25.0 Seconds

Factory Default: 1.0 Seconds

The Drive interprets feedback loss whenever the feedback signal drops below the value of b5-13 and stays below that level for at least the time set into b5-14. See Figure below for timing details.

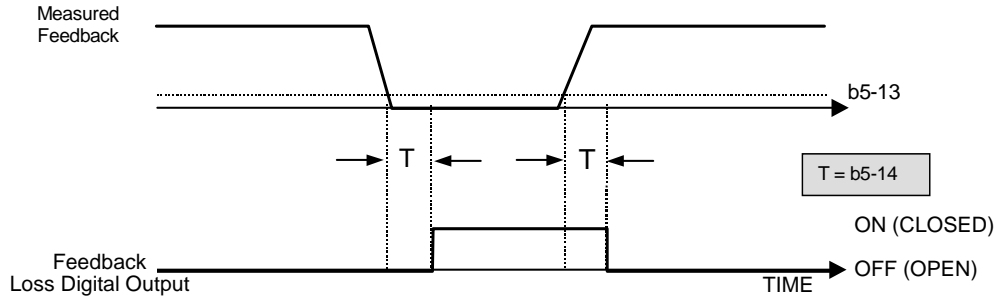

Fig. 18 Loss of PI Feedback Feature

■ b5-15 Sleep Function Start Level

Setting Range: 0.0 to 200.0 Hz

Factory Default: 0.0 Hz

■ b5-16 Sleep Delay Time

Setting Range: 0.0 to 25.5 Seconds

Factory Default: 0.0 Seconds

The Sleep Function can be programmed to prevent running the Drive when the PI loop output or the speed command is so low that no usable work is being done and/or equipment damage may result. The Sleep Function can be Enabled by entering a value in parameter b5-15. If the Drive's output drops below the level set by the Sleep Function Start Level (b5-15) and remains there at least as long as the delay time determined by the Sleep Delay Time (b5-16), then the Drive's internal Run command drops out and the Drive output ceases. Though the Drive's output has ceased, all other Drive functions continue. Once the Drive's theoretical output returns to a level above the Sleep Function Start Level (b5-15) and remains above that level for at least the Sleep Delay Time (b5-16), the internal Run command returns and the Drive output begins again. The b5-16 Delay Time prevents oscillation about the sleep level.

Note: The sleep function can be used even if the PI function is disabled (b5-01 = "0: Disabled").

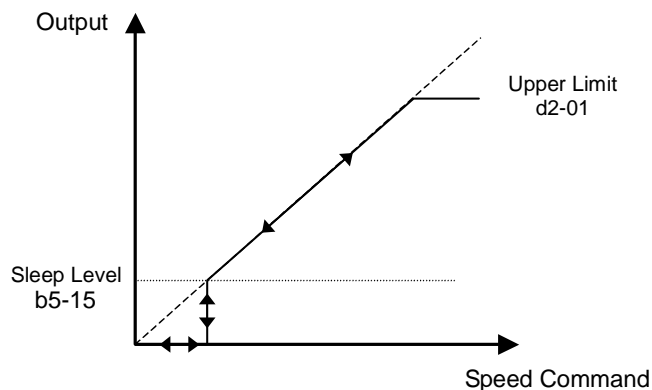

Fig. 19 Sleep Function Response

■ b5-17 PI Accel/Decel Time

Setting Range: 0.0 to 25.5 Seconds

Factory Default: 0.0 Seconds

This is a soft start function that is applied to the PI setpoint analog input. Instead of having nearly instantaneous changes in signal levels, there is a programmed ramp applied to level changes. When changing setpoints the error can be limited by gradually ramping the setpoint through the use of parameter b5-17.

■ b5-18 PI Setpoint Selection

Setting	Description
0	Disabled (<i>factory default</i>)
1	Enabled

In order to use parameter b5-19 as the PI Setpoint, set parameter b5-18= “1: Enabled”. If b5-18= “0: Disabled” the PI Setpoint will either be:

- Modbus Register 06H (If Register 0FH bit 1 is high)
- The active speed command (i.e. Determined by the setting of b1-01). See Table 1 “Setpoint Options”

■ b5-19 PI Setpoint Value

Setting Range: 0.00 to 100.00%

Factory Default: 0.00%

Parameter b5-19 is for a PI Setpoint value. When b5-18= “1: Enabled”, the value of b5-19 will take precedent over any other PI setpoint unless the Drive is set up for Differential Feedback, in which case, b5-18 and b5-19 have no affect on the PI function.

■ b5-20 PI Setpoint Display Scaling

Setting	Description
0	Hz (<i>factory default</i>)
1	%
3	RPM (Synchronous)
3	Engineering Units

The PI Setpoint Display Scaling value (b5-20) is a scaling factor that is applied to the monitor display for both the PI Setpoint (U1-38) and the PI Feedback (U1-24).

If b5-20 is:	U1-24 and U1-38 Display Increments.
0	0.01 Hz
1	0.00%
2 through 39 (enter the # of motor poles)	0RPM
40 through 39999	Engineering Units

If the monitors seem more natural in terms of percentage, set b5-20= 1. If the monitors are easier to work with when displaying the equivalent synchronous RPM, set b5-20= [the number of motor poles].
 If another engineered unit, such a fpm or cfm, is desired, set b5-20= xxxxx where

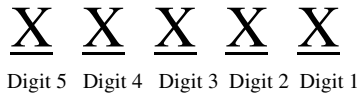

Digits 1 through 4 set the desired number to be displayed at 100% speed.
 Digit 5 determines the number of decimal places

- If Digit 5 = 0 number format is XXXX
- If Digit 5 = 1 number format is XXX.X
- If Digit 5 = 2 number format is XX.XX
- If Digit 5 = 3 number format is X.XXX

For example:

If b5-20= 10425 then at 100% output the digital operator would display 42.5 for monitor U1-38 or U1-24.

■ b5-21 Sleep Source

Setting	Description
0	SFS Input (Output of PI block)
1	PI Setpoint (<i>factory default</i>)
2	Snooze

Parameter b5-21 selects the sleep function characteristic action:

When b5-21= “0: SFS Input” the sleep function start level (b5-15) is compared to the Drive’s output (Speed Command after PI block). This is the setting that should be used for open loop or closed loop control.

It is also possible to have the sleep function start level (b5-15) compared to the Drive input or setpoint. For this special application set b5-21= “1: PI Setpoint”.

When b5-21= “2: Snooze” a variation of the sleep function called “Snooze” is enabled, see parameter b5-22 to b5-27.

IMPORTANT | The sleep function can be used even if the PI function is disabled (b5-01= “0: Disabled”).

■ b5-22 PI Snooze Level

Setting Range: 0 to 100%
 Factory Default: 0%

■ b5-23 PI Snooze Delay Time

Setting Range: 0 to 3600 Seconds
 Factory Default: 0 Seconds

■ b5-24 PI Snooze Deactivation Level

Setting Range: 0 to 100%

Factory Default: 0%

The Snooze Function is a variation on the Sleep Function. The Snooze function must be selected by setting parameter b5-21= “2: Snooze”. Once the Snooze Function is selected, the Drive monitors the output frequency. If the output frequency drops below the PI Snooze Level (b5-22), and stays below that level for at least the PI Snooze Delay Time (b5-23), the Drive output shuts off. This is different from the Sleep Function because it is the feedback that must drop below the PI Snooze Deactivation Level (b5-24) before normal Drive output will begin again. See Figure 20 below.

■ b5-25 PI Setpoint Boost Setting

Setting Range: 0 to 100%

Factory Default: 0%

Just before the Snooze Function is activated, the PI Setpoint can be temporarily increased to create an overshoot of the intended PI Setpoint. The temporary boost is determined by the PI Setpoint Boost Setting (b5-25). Once the temporary boost level is reached (or the PI Maximum Boost Time (b5-26) is exceeded), the Drive output shuts off (snoozes) and the intended PI Setpoint returns. From this point on, the Snooze Function operates normally and the Drive output returns when the feedback level drops below b5-24. See Figure 20 below.

■ b5-26 PI Maximum Boost Time

Setting Range: 0 to 3600 Seconds

Factory Default: 0 Seconds

Associated with the Snooze Function. In cases where the temporary PI Setpoint (intended PI setpoint + PI Setpoint Boost) cannot be reached within the PI Maximum Boost Time (b5-26), the Setpoint Boost is interrupted and the Drive output is turned off.

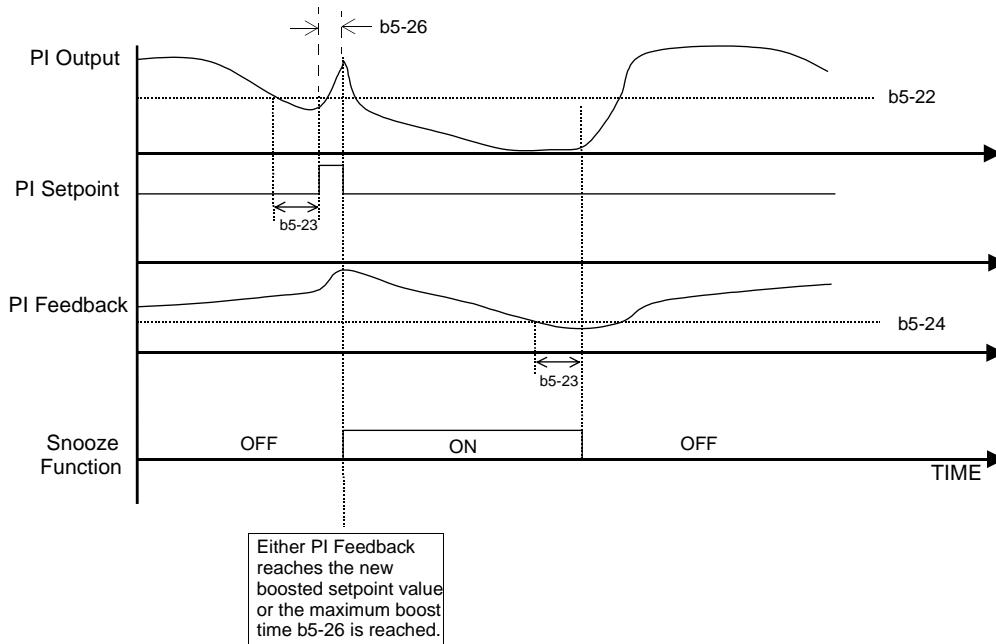

Fig. 20 Snooze Function Operation

■ b5-27 PI Snooze Feedback Level

Setting Range: 0 to 100%

Factory Default: 60%

This is a second method of initiating the Snooze Function. If the PI feedback level exceeds the PI Snooze Feedback Level (b5-27), then the Drive output shuts off. Once the PI feedback drops below the PI Snooze Deactivation Level (b5-24) then normal Drive and PI operation return.

■ b5-28 PI Feedback Square Root Function Activation

Setting	Description
0	Disabled (<i>factory default</i>)
1	Enabled

If b5-28= “1: Enabled”, the square root of the PI feedback is compared to the PI Setpoint in order to determine appropriate Drive output to properly regulate the system. This is helpful in cases where the measured feedback is pressure but the PI loop needs to regulate flow.

■ b5-29 PI Square Root Gain

Setting Range: 0.00 to 2.00

Factory Default: 1.00

A multiplier applied to the square root of the feedback.

■ b5-30 PI Output Square Root Monitor Selection

Setting	Description
0	Disabled (<i>factory default</i>)
1	Enabled

If the PI Function is regulating the flow of a closed loop system by using a pressure feedback, it may be convenient to view the square root of the PI output using monitor U1-37.

◆ b8 Energy Savings

The energy savings function improves overall system operating efficiency by operating the motor at its highest efficiency. This is accomplished by continuously monitoring the motor load and adjusting the motor terminal voltage so that the motor always operates near its rated slip frequency. A motor is most efficient when operating near rated slip conditions.

■ b8-01 Energy Savings Selection

Setting	Description
0	Disabled (<i>factory default</i>)
1	Enabled

When the Energy Savings function is enabled (b8-01= “1: Enabled”), the Drive reduces the output voltage to the motor below the voltage value specified by the programmed V/f pattern whenever the motor load is light. Since torque is reduced during this voltage reduction, the voltage has to return to normal levels when the load returns. The energy savings is realized through improved motor efficiency. The reduced output voltage causes increased rotor slipping even with a light load. A motor is most efficient when operating fully loaded (i.e. operating at rated slip).

■ b8-04 Energy Saving Coefficient Value

Setting Range: 0.0 to 655.0

Factory Default: Model Dependent

Parameter b8-04 is used in maximizing motor efficiency. The factory setting will be Drive capacity dependant but can be adjusted in small amounts while viewing the kW monitor (U1-08) and running the Drive to minimize the output kW. A larger value typically results in less voltage to the motor and less energy consumption. Too large a value will cause the motor to stall.

■ b8-05 Power Detection Filter Time

Setting Range: 0 to 2000 mS

Factory Default: 20 mS

The Energy Saving function will search out the lowest output voltage in order to achieve minimum output power usage. Parameter b8-05 determines how often the output power (kW) is measured and the output voltage is adjusted.

■ b8-06 Search Operation Voltage Limit

Setting Range: 0 to 100 %

Factory Default: 0%

Once Energy Savings is enabled and the optimal energy saving coefficient value has been set, the programmer can have the Drive further search out the proper voltage to achieve the lowest output power by making minute changes to the output voltage and measuring the output power every b8-05 ms. Parameter b8-06 sets limits to the range over which the voltage will be adjusted in order to minimize the power output. Settings too large a value may allow the motor to stall if the load is applied abruptly.

If b8-06= 0, then the optimum voltage search operation is disabled (but not Energy Savings itself).

◆ C1 Accel/Decel

- **C1-01 Acceleration Time 1**
- **C1-02 Deceleration Time 1**
- **C1-03 Acceleration Time 2**
- **C1-04 Deceleration Time 2**

Setting Range: 0.0 to 6000.0 Seconds

Factory Default: 30.0 Seconds

C1-01 (Acceleration Time 1) sets the time to accelerate from zero to maximum speed (E1-04). C1-02 (Deceleration Time 1) sets the time to decelerate from maximum speed to zero. C1-01 and C1-02 are the factory default active accel/decel “pair”. Another accel/decel pair (C1-03 and C1-04) exists that can be activated by a multi-function digital input (H1-0x= 7), or specified by a switch over frequency as programmed in parameter C1-11.

Note: If fan applications employing duct high pressure safety limit switches, it may be necessary to further adjust the deceleration time to avoid high pressure limit trips due to damper closure as the system is shut down. (An alternate solution in this situation is to set parameter b1-03 to “Coast to Stop”).

■ C1-09 Fast Stop Time

Setting Range: 0.0 to 6000.0 Seconds

Factory Default: 10.0 Seconds

A special deceleration parameter is available for use with emergency or fault operations. Parameter C1-09 will set a special deceleration that can be operated by closing a digital input configured as H1-0x= 15 or H1-0x= 17. A digital input configured as H1-0x= 15 will look for a switch closure before initiating the Fast Stop operation. A digital input configured as H1-0x= 17 will look for the switch opening before initiating the Fast Stop operation.

Unlike a standard deceleration time, once the Fast Stop operation is initiated even momentarily, the Drive cannot be re-operated until the deceleration is complete, the Fast Stop input is cleared, and the Run command is cycled.

■ C1-11 Accel/Decel Switch Frequency

Setting Range: 0.0 to 200.0 Hz

Factory Default: 0.0 Hz

The Drive can be programmed to automatically switch between the two sets of Accel/Decel parameters on the fly. No digital input is required. If parameter C1-11 is set to a frequency other than zero, the Drive will use Acceleration 1 and Deceleration 1 whenever the output frequency is equal to or above the value of C1-11 and use Acceleration 2 and Deceleration 2 whenever the output frequency is below the value of C1-11.

A multi-function input programmed as “Multi-Acc/Dec 1” will have priority over C1-11. For example, if the output frequency is greater than the value of C1-11 but a digital input configured as “Multi-Acc/Dec 1” is closed then Acceleration 2 and Deceleration 2 are active.

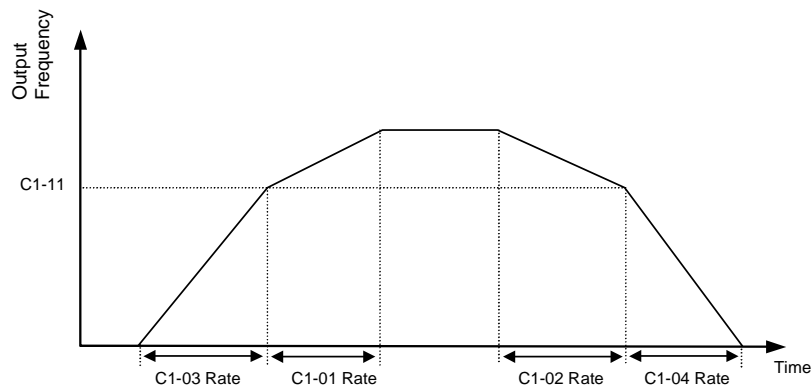

Fig. 21 Accel/Decel Switch Frequency Operation

◆ C2 S-Curve Acc

■ C2-01 S-Curve Characteristic at Accel Start

C2-02 S-Curve Characteristic at Accel End

Setting Range:0.00 to 2.50 Seconds

Factory Default:0.20 Seconds

Parameters C2-01 and C2-02 will affect the acceleration rate of the output frequency in order to reduce shock to the load. The S-curve addition to the acceleration profile can ramp the acceleration rate from a 0 to the rate specified by the active Acceleration Time (C1-01 or C1-03) and back to 0.

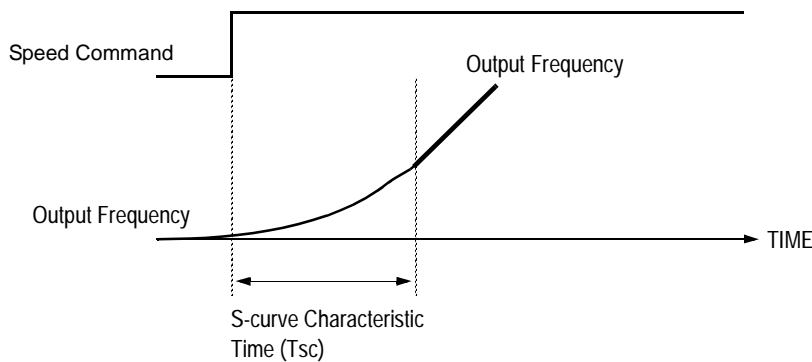

Fig. 22 S-curve Characteristic Timing Diagram

The S-Curve transition into and out of the active acceleration rate can be programmed independently. C2-01 will ramp up the acceleration from no acceleration up to the rate of C1-01 or C1-03. C2-02 will ramp the acceleration rate from the rate of C1-01 or C1-03 back down to no acceleration (constant speed). The use of S-Curve characteristics will lengthen the overall acceleration time as follows:

$$\text{Overall Acceleration Time} = \text{Active Acceleration Time} + \frac{(C2 - 01) + (C2 - 02)}{2}$$

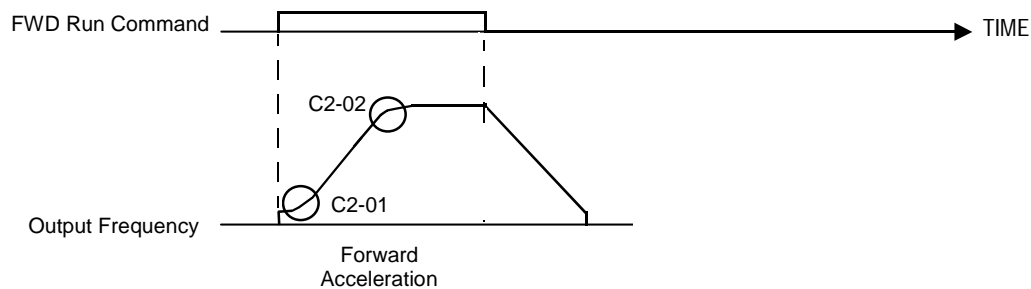

Fig. 23 S-Curve Characteristic Timing Diagram

◆ C4 Torque Comp

■ C4-01 Torque Compensation Gain

Setting Range: 0.00 to 2.50
Factory Default: 1.00

■ C4-02 Torque Compensation Primary Delay Time

Setting Range: 0 to 10000 mS
Factory Default: 200 mS

The Torque Compensation function compensates for insufficient torque production at start-up and during low speed operation. The Drive will detect increases in the motor load by monitoring the output current and compensate by increasing the output voltage. The increased output voltage leads to an increase in usable torque.

Parameter C4-01 sets the aggressiveness of the compensation for IR (resistive) and IL (inductive) losses in the motor windings, which are more pronounced at lower speeds. Normally C4-01 does not need to be changed but may require adjustment in the following cases:

- If the Drive to motor cable is long, increase C4-01
- If the motor capacity is smaller than the Drive capacity, increase C4-01
- If the low speed motor performance is unstable, decrease C4-01.
- If the output current level exceeds the Drive's rated current while operating at low speeds, increase C4-01

Parameter C4-02 determines how quickly the Torque Compensation function will react to situations of insufficient torque. Again, C4-02 will not normally require adjustment except for the following situations:

- If the motor vibrates, increase C4-02
- If the motor response is sluggish (and possibly stalls), decrease C4-02

IMPORTANT | Performing Auto-tuning can enhance low speed performance.

■ C6-01 Normal Duty Selection

Setting	Description
1	Normal Duty 1
2	Normal Duty 2 (<i>factory default</i>)

Adjustment of parameter C6-01 will affect the Drive's overload and carrier frequency settings. Generally this parameter does not need adjustment and should be left at the factory default setting

■ C6-02 Carrier Frequency Selection

Setting	Description
0	Low Noise
1	Fc=2.0 kHz
2	Fc=5.0 kHz
3	Fc=8.0 kHz
4	Fc=10.0 kHz
5	Fc=12.5 kHz
6	Fc=15.0 kHz
F	Program

*The factory default setting is model dependent

Parameter C6-02 sets the switching frequency of the Drive's output transistors. It can be changed in order to reduce audible noise and also reduce leakage current. Cases that may require adjustment to the C6-02 are:

- If the wiring length between the Drive and the motor is long, decrease the carrier frequency

Wiring Length	164 ft or less	328 ft or less	Over 328 ft
C6-02 (carrier frequency) setting	1 to 6 (15 kHz max.)	1 to 4 (10 kHz max.)	1 to 2 (5 kHz max.)

- If speed and torque are inconsistent at low speeds, decrease the carrier frequency
- If leakage current from the Drive is large, decrease the carrier frequency
- If the audible motor noise is too great, increase the carrier frequency (may require Drive current derating)

When parameter C6-02 is set to "0: Low Noise" the Drive uses a carrier frequency of 2 kHz and reduces the motor audible noise by approximately 5 db. over the conventional 2 kHz setting (C6-02= 1). The Drive modulates the nominal PWM pattern to achieve the lower noise. This setting is normally used with high starting torque loads that are frequently started and stopped or, applications where leakage current needs to be minimized and motor audible noise is important.

208V-240V Drives 1						480V Drives 1					
Model CIMR-E7U	C6-02 Carrier Frequency (kHz)	C6-03 Carrier Frequency Max. (kHz)	C6-04 Carrier Frequency Min. (kHz)	C6-05 Carrier Frequency Gain	Nominal HP	Model CIMR-E7U	C6-02 Carrier Frequency (kHz)	C6-03 Carrier Frequency Max. (kHz)	C6-04 Carrier Frequency Min. (kHz)	C6-05 Carrier Frequency Gain	Nominal HP
20P4	4 (10.0)	4 (10.0)	4 (10.0)	0	0.5/0.75	40P4	6 (15.0)	6 (15.0)	6 (15.0)	0	0.5/0.75
20P7	4 (10.0)	4 (10.0)	4 (10.0)	0	1	40P7	6 (15.0)	6 (15.0)	6 (15.0)	0	1
21P5	4 (10.0)	4 (10.0)	4 (10.0)	0	1.5/2	41P5	6 (15.0)	6 (15.0)	6 (15.0)	0	1.5/2
22P2	3 (8.0)	3 (8.0)	3 (8.0)	0	3	42P2	6 (15.0)	6 (15.0)	6 (15.0)	0	3
23P7	4 (10.0)	4 (10.0)	4 (10.0)	0	5	43P7	6 (15.0)	6 (15.0)	6 (15.0)	0	5
25P5	6 (15.0)	6 (15.0)	6 (15.0)	0	7.5	45P5	6 (15.0)	6 (15.0)	6 (15.0)	0	7.5
27P5	6 (15.0)	6 (15.0)	6 (15.0)	0	10	47P5	6 (15.0)	6 (15.0)	6 (15.0)	0	10
2011	3 (8.0)	3 (8.0)	3 (8.0)	0	15	4011	3 (8.0)	3 (8.0)	3 (8.0)	0	15/20
2015	4 (10.0)	4 (10.0)	4 (10.0)	0	20	4015	4 (10.0)	4 (10.0)	4 (10.0)	0	25
2018	4 (10.0)	4 (10.0)	4 (10.0)	0	25	4018	4 (10.0)	4 (10.0)	4 (10.0)	0	30
2022	4 (10.0)	4 (10.0)	4 (10.0)	0	30	4030	3 (8.0)	3 (8.0)	3 (8.0)	0	40/50
2030	4 (10.0)	4 (10.0)	4 (10.0)	0	40	4037	3 (8.0)	3 (8.0)	3 (8.0)	0	60
2037	2 (5.0)	2 (5.0)	2 (5.0)	0	50	4045	3 (8.0)	3 (8.0)	3 (8.0)	0	75
2045	2 (5.0)	2 (5.0)	2 (5.0)	0	60	4055	2 (5.0)	2 (5.0)	2 (5.0)	0	100
2055	3 (8.0)	3 (8.0)	3 (8.0)	0	75	4075	2 (5.0)	2 (5.0)	2 (5.0)	0	125
2075	1 (2.0)	1 (2.0)	1 (2.0)	0	75/100	4090	3 (8.0)	3 (8.0)	3 (8.0)	0	150
2090	1 (2.0)	1 (2.0)	1 (2.0)	0	125	4110	2 (5.0)	2 (5.0)	2 (5.0)	0	200
2110	1 (2.0)	1 (2.0)	1 (2.0)	0	150	4160	2 (5.0)	2 (5.0)	2 (5.0)	0	250
						4185	1 (2.0)	1 (2.0)	1 (2.0)	0	300/350
						4220	1 (2.0)	1 (2.0)	1 (2.0)	0	450
						4300	1 (2.0)	1 (2.0)	1 (2.0)	0	500+

■ **C6-03 Carrier Frequency Upper Limit**
C6-04 Carrier Frequency Lower Limit

Setting Range: 0.4 to 15.0 kHz
 Factory Default: Model Dependent

■ **C6-05 Carrier Frequency Proportional Gain**

Setting Range: 0 to 99
 Factory Default: 0

It is possible to configure the Drive such that the carrier frequency will automatically increase as the output frequency is raised (synchronous carrier). A synchronous carrier can be used by setting parameter C6-02=F: Program. The profile of the carrier frequency is show below and can be configured to the users specification by setting the carrier frequency upper and lower limits (C6-03 and C6-04 respectively) and a carrier frequency proportional gain (C6-05).

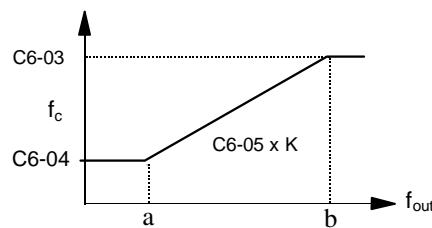

Fig. 24 Synchronous Carrier Frequency Characteristics

The frequencies that correspond to the breakpoints a and b will be determined by the value of **K** given in the table below and the following formulas:

Conditions	K Value
C6-03 > 10.0kHz	3
10.0kHz > C6-03 > 5.0kHz	2
C6-03 < 5.0kHz	1

$$a = \frac{C6-04}{C6-05 \times K}$$

$$b = \frac{C6-03}{C6-05 \times K}$$

IMPORTANT | If C6-05 > 6 and C6-04 > C6-03 the Drive will fault and display and OPE11 error.

◆ d1 Preset References

- d1-01 Frequency Reference 1
- d1-02 Frequency Reference 2
- d1-03 Frequency Reference 3
- d1-04 Frequency Reference 4

Setting Range: 0.00 to E1-04 Value
Factory Default: 0.00 Hz

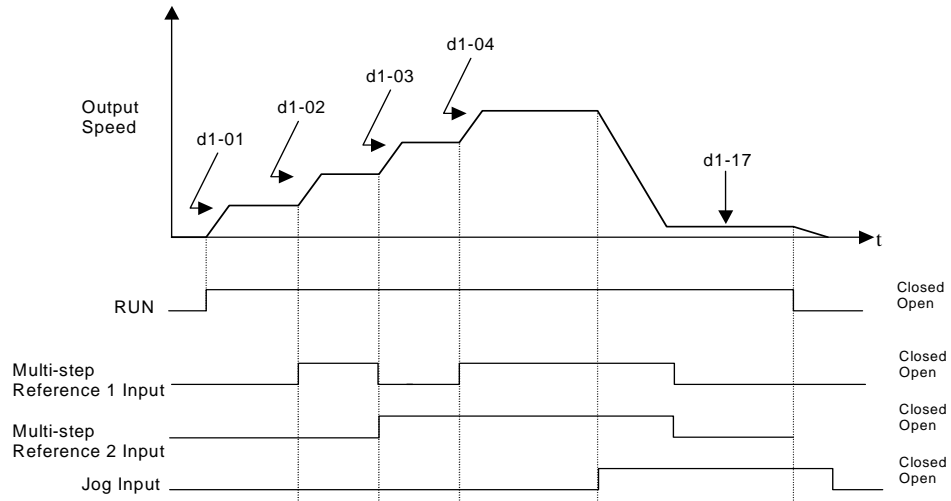

Fig. 25. Preset Reference Timing Diagram

■ d1-17 Jog Frequency Reference

Setting Range: 0.00 to E1-04 Value

Factory Default: 6.00 Hz

The Drive can be programmed to utilize digital inputs to change between four presets speeds and a jog speed. It is a two-step process to set the Drive up for preset speeds. First, d1-01 through d1-04 and d1-17 must be programmed with the desired preset speeds and the desired jog speed, respectively. Next, up to three of the Drive's digital inputs (Terminals S3 through S7) need to be programmed (via parameters H1-01 to H1-05) and wired (to normally open contacts) as Multi-step Speed Reference 1, Multi-step Speed Reference 2, and Jog Frequency.

Table 4 Preset Speed Truth Table

Preset Speed	Terminal programmed as Multi-step Reference 1	Terminal programmed as Multi-step Reference 2	Terminal programmed as Jog Reference	Details
1	OFF	OFF	OFF	Frequency Reference 1 (d1-01) or analog input A1 [#] (determined by b1-01, see page 49)
2	ON	OFF	OFF	Frequency Reference 2 (d1-02) or analog input A2 [#] (determined by H3-09, see page 49)
3	OFF	ON	OFF	Frequency Reference 3 (d1-03)
4	ON	ON	OFF	Frequency Reference 4 (d1-04)
5	-	-	ON*	Jog Frequency (d1-17)

* The Jog Frequency input is given priority over the multi-step speeds. [#] Shown for H3-13="0: Main Fref TA1"; A1 and A2 are reversed if H3-13="1: Main Fref TA2"

As shown in the above table, it is possible to use analog inputs in place of Frequency Reference 1 and Frequency Reference 2.

- If b1-01= "1: Terminals" then the analog input A1 will be used instead of Frequency Reference 1 for the first preset speed. If b1-01= "0: Operator", then Frequency Reference 1 will be used.
- If H3-09= "2: Aux Reference" then the analog input A2 will be used instead of Frequency Reference 2 for the second preset speed. If H3-09≠2 then Frequency Reference 2 will be used.

IMPORTANT

The programming of d1-01 through d1-04 and d1-17 will be affected by the setting of o1-03. The programming of these parameters will be in the units specified by Display Scaling parameter (o1-03).

◆ d2 Reference (Speed Command) Limits

■ d2-01 Frequency Reference Upper Limit

Setting Range: 0.0 to 110.0%
Factory Default: 100.0%

■ d2-02 Frequency Reference Lower Limit

Setting Range: 0.0 to 110.0%
Factory Default: 0.0%

The use of parameters d2-01 and d2-02 places limitations on the speed command that the Drive will accept. The parameters are set in units of percentage of the maximum frequency (E1-04) and provide limits on any remote speed command input. By entering upper or lower frequency limits, the Drive programmer can prevent operation of the Drive above or below levels that may cause resonance, equipment damage or discomfort (see also parameter d3-0X). For example, limits may be needed to prevent low speed operation of: Cooling tower fans with gear boxes, pumps with pressure dependent seals, or AHUs with minimum delivery requirements.

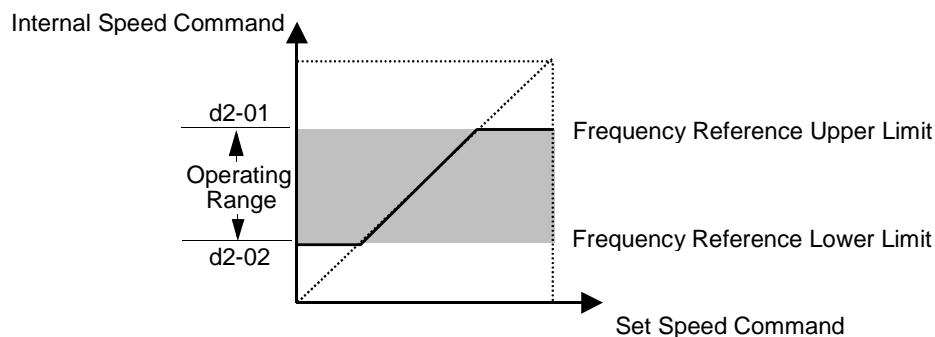

Note: See also the “Sleep” function in Figure 19 for alternate “lower limit” implementation.

Fig. 26 Frequency Reference Upper and Lower Limit Effects on the Speed Command

■ d2-03 Master Speed Reference Lower Limit

Setting Range: 0.0 to 110.0%
Factory Default: 0.0%

Unlike Frequency Reference Lower Limit (d2-02) which will affect the speed command no matter where it is sourced from (i.e. analog input, preset speed, jog speed, etc.), the Master Speed Reference Lower Limit (d2-03) sets a low speed threshold that will only affect the analog input that is the active master speed frequency (as determined by parameter H3-13 and H3-09). This parameter allows a minimum speed to be programmed for the master reference while allowing a lower speed to be set as a jog reference. If the speed commanded by the active master speed frequency is below the setting of d2-03, then the Drive will operate at the speed specified by d2-03.

◆ d3 Jump Frequencies

- d3-01 Jump Frequency 1
- d3-02 Jump Frequency 2
- d3-03 Jump Frequency 3

Setting Range: 0.0 to 200.0 Hz
Factory Default: 0.0 Hz

■ d3-04 Jump Frequency Width

Setting Range: 0.0 to 20.0 Hz
Factory Default: 1.0 Hz

In order to avoid continuous operation at a speed that causes resonance in driven machinery, the Drive can be programmed with jump frequencies that will not allow continued operation within specific frequency ranges. If a speed is commanded that falls within a dead band, or Jump Frequency, the Drive will clamp the frequency reference just below the dead band and only accept higher speed commands when the commanded speed rises above the upper end of the dead band, for increasing references. Similarly, the Drive will clamp the frequency reference just above the dead band and only accept lower speed commands when the command speed falls below the lower end of the dead band, for decreasing references.

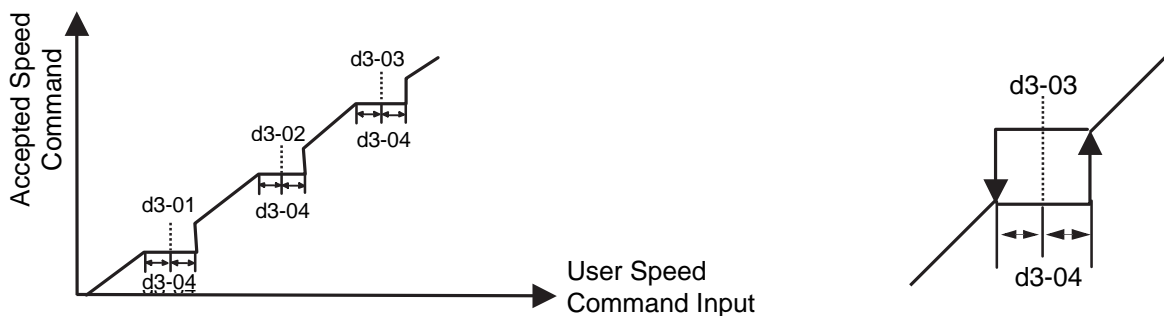

Fig. 27 Jump Frequency Characteristics

Setting the center point of the dead band with the d3-01 through d3-03 parameters and setting the width of the dead band with parameter d3-04 determines the dead band characteristics. The programmer can set up to three Jump Frequencies. If multiple Jump Frequencies are programmed the following rule applies:

$$d3-01 <= d3-02 <= d3-03$$

◆ d4 Sequence

■ d4-01 MOP Reference Memory

Setting	Description
0	Disabled (<i>factory default</i>)
1	Enabled

The Drive offers the capacity to change the speed command much the way a Motor Operated Potentiometer (MOP) would. Using programmed digital inputs configured as MOP Increase (H1-0x= 10) and MOP Decrease (H1-0x= 11), the Drive will increase the speed command whenever the MOP Increase input is closed and decrease the speed command whenever the MOP Decrease is closed. The speed command will remain constant whenever both inputs are open or closed.

Parameter d4-01 determines whether the last speed command, before the Run command was removed, is remembered even if the power is cycled to the Drive. If d4-01= “0: Disabled”, then when a new Run command is issued the Drive’s speed command will be 0 rpm. If d4-01= “1: Enabled”, then the speed command will be the last commanded speed before the Run command was removed (See Figure 34).

■ d4-02 Trim Control Level

Setting Range: 0 to 100% of Maximum Speed

Factory Default: 10% of Maximum Speed

Using digital inputs, the Drive can add or subtract a set percentage of the maximum output frequency (E1-04) to or from the speed commanded by the analog input. Parameter d4-02 sets the percentage that will be used to trim the speed command. Once the applicable digital input that is configured as either the Trim Control Increase (H1-0x= 1C) or Trim Control Decrease (H1-0x= 1D) is re-opened, the speed will go back to the speed determined by the analog reference.

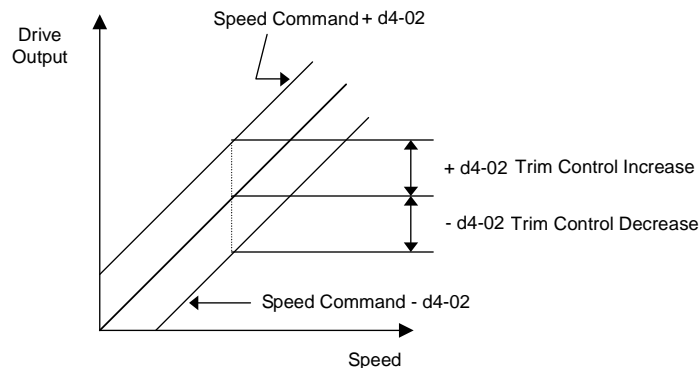

Fig. 28 Trim Control Effect on Speed Command

◆ E1 V/f Pattern

■ E1-01 Input Voltage Setting

Setting Range: 155.0V to 255.0V (208V/240V Models)
310.0V to 510.0V (480V Models)

Factory Defaults: 208.0V (208V Models)
240.0V (240V Models)
480.0V (480V Models)

Set the Input Voltage parameter (E1-01) to the nominal voltage of the connected AC power supply. This parameter adjusts the levels of some protective features of the Drive (i.e. Overvoltage, Stall Prevention, etc.). E1-01 also serves as the Maximum/Base Voltage used by the Preset V/Hz curves (E1-03= 0 to D).

■ E1-03 V/f Pattern Selection

Setting	Description
0	50 Hz
1	60 Hz Saturation
2	50 Hz Saturation
3	72 Hz
4	50 Hz VT1
5	50 Hz VT2
6	60 Hz VT1
7	60 Hz VT2
8	50 Hz HST1
9	50 Hz HST2
A	60 Hz HST1
B	60 Hz HST2
C	90 Hz
D	120 Hz
F	Custom V/f (<i>factory default, with parameter values per setting 1</i>)
FF	Custom w/o limit

The Drive operates utilizing a set V/f pattern to determine the appropriate output voltage level for each commanded speed. There are 14 different preset V/f patterns to select from with varying voltage profiles, saturation levels (frequency at which maximum voltage is reached), and maximum frequencies.

There are also settings for Custom V/f patterns that will allow the programmer to manually set (“Customize”) the V/f pattern using parameters E1-04 through E1-13.

Using parameter E1-03, the programmer can select one of the preset V/f patterns or chose between a custom V/F pattern with an upper voltage limit (E1-03= “F: Custom V/F”) and a custom V/f pattern without a voltage limit (E1-03= “FF: Custom w/o limit”).

Table 5 Preset V/f Patterns											
	Specifications		E1-03	V/f Pattern *1		Specifications		E1-03	V/f Pattern *1		
General-purpose	50Hz		0		High Starting Torque *2	50Hz		8			
						High Starting Torque 2		9			
	60Hz Saturation		1			60Hz		High Starting Torque 1		A	
	50Hz Saturation		2			High Starting Torque 2		B			
72Hz		3		90Hz		C					
Variable Torque	50Hz		4		High Speed Operation	120Hz		D			
	Variable Torque 2		5								
	60Hz		6								
	Variable Torque 2		7								

If one of the custom V/f patterns is selected, then parameters E1-04 through E1-13 will determine the V/F pattern.

Table 5 is for 240V class units only. For 480V class units multiply the voltage value by 2.

IMPORTANT

When a factory Initialization is performed, the setting of E1-03 is unaffected but the settings of E1-04 through E1-13 are returned to their factory default settings.

■ **E1-04 Maximum Output Frequency**

Setting Range: 0.0 to 120.0 Hz

Factory Default: 60.0 Hz

■ E1-05 Maximum Output Voltage

Setting Range: 0.0 to 255.0V (240V Models)
0.0 to 510.0V (480V Models)

Factory Defaults: 240.0V (240V Models)
480.0V (480V Models)

■ E1-06 Base Frequency

Setting Range: 0.0 to 200.0 Hz (settings above 120.0 Hz are currently not supported)
Factory Default: 60.0 Hz

■ E1-07 Mid Output Frequency A

Setting Range: 0.0 to 200.0 Hz (settings above 120.0 Hz are currently not supported)
Factory Default: 3.0 Hz

■ E1-08 Mid Output Voltage A

Setting Range: 0.0 to 255.0V (240V Models)
0.0 to 510.0V (480V Models)

Factory Defaults: 18.0V (240V Models)
33.6V (480V Models)

■ E1-09 Minimum Output Frequency

Setting Range: 0.0 to 200.0 Hz (settings above 120.0 Hz are currently not supported)
Factory Default: 1.5 Hz

■ E1-10 Mid Output Voltage

Setting Range: 0.0 to 255.0V (240V Models)
0.0 to 510.0V (480V Models)

Factory Defaults: 10.8V (240V Models)
16.8V (480V Models)

■ E1-11 Mid Output Frequency B

Setting Range: 0.0 to 200.0 Hz (settings above 120.0 Hz are currently not supported)
Factory Default: 0.0 Hz

■ E1-12 Mid Output Voltage B

E1-13 Base Voltage

Setting Range: 0.0 to 255.0V (240V Models)
0.0 to 510.0V (480V Models)

Factory Defaults: 0.0V (240V Models)
0.0V (480V Models)

To set up a custom V/f pattern, program the points shown in the diagram below using parameters E1-04 through E1-13. Be sure that the following condition is true:

$$E1-09 \leq E1-07 \leq E1-06 \leq E1-11 \leq E1-04$$

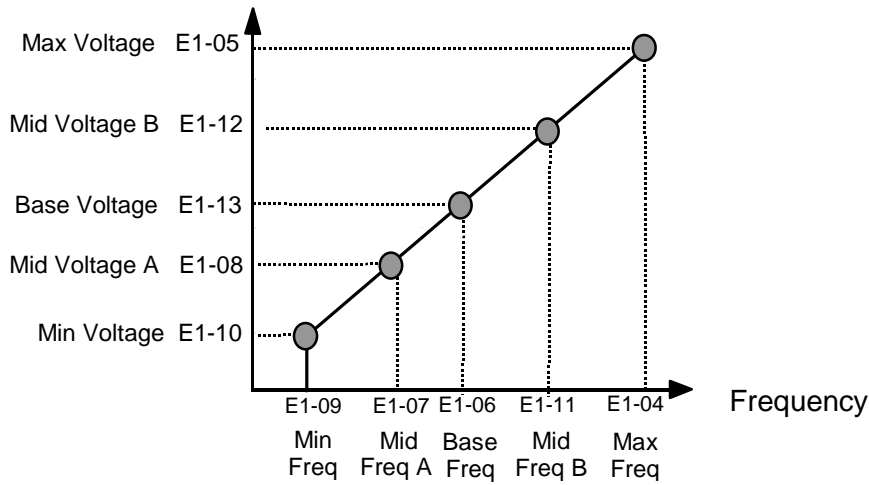

Fig. 29 Custom V/f Pattern Programming Curve

Increasing the voltage in the V/f pattern increases the available motor torque. However, when setting a custom V/f pattern, increase the voltage gradually while monitoring the motor current, to prevent:

- Drive faults as a result of motor over-excitation
- Motor overheating or excessive vibration

Tables 5 and 6 are for 240V class units only. For 480V class units, multiply the voltage values by 2.

Table 6 V/f Pattern Default Settings for Drive Capacity 0.5 to 2HP for 240V Class										
Parameter No.	Name	Unit	Factory Setting							
E1-03	V/f Pattern Selection	—	0	1	2	3	4	5	6	7
E1-04	Max Output Frequency	Hz	50.0	60.0	60.0	72.0	50.0	50.0	60.0	60.0
E1-05	Max Output Voltage	V	240.0	240.0	240.0	240.0	240.0	240.0	240.0	240.0
E1-06	Base Frequency	Hz	50.0	60.0	50.0	60.0	50.0	50.0	60.0	60.0
E1-07	Mid Output Frequency A	V	2.5	3.0	3.0	3.0	25.0	25.0	30.0	30.0
E1-08	Mid Output Voltage A	V	17.2	17.2	17.2	17.2	40.2	57.5	40.2	57.5
E1-09	Min Output Frequency	Hz	1.3	1.5	1.5	1.5	1.3	1.3	1.5	1.5
E1-10	Mid Output Voltage	V	10.3	10.3	10.3	10.3	9.2	10.3	9.2	10.3
E1-11	Mid Output Frequency B	Hz	0	0	0	0	0	0	0	0
E1-12	Mid Output Voltage B	V	0	0	0	0	0	0	0	0
E1-13	Base Voltage	V	0	0	0	0	0	0	0	0

For 480V class units, the value is twice that of 240V class units.

Table 6 V/f Pattern Default Settings for Drive Capacity 0.5 to 2HP for 240V Class (Continued)

Parameter No.	Name	Unit	Factory Setting						
			8	9	A	B	C	D	F
E1-03	V/f Pattern Selection	—	8	9	A	B	C	D	F
E1-04	Max. Output Frequency	Hz	50.0	50.0	60.0	60.0	90.0	120.0	60.0
E1-05	Max. Output Voltage	V	240.0	240.0	240.0	240.0	240.0	240.0	240.0
E1-06	Base Frequency	Hz	50.0	50.0	60.0	60.0	60.0	60.0	60.0
E1-07	Mid. Output Frequency A	V	2.5	2.5	3.0	3.0	3.0	3.0	3.0
E1-08	Mid. Output Voltage A	V	21.8	27.6	21.8	27.6	17.2	17.2	17.2
E1-09	Min. Output Frequency	Hz	1.3	1.3	1.5	1.5	1.5	1.5	1.5
E1-10	Mid. Output Voltage	V	12.6	14.9	12.6	17.2	10.3	10.3	10.3
E1-11	Mid Output Frequency B	Hz	0	0	0	0	0	0	0
E1-12	Mid Output Voltage B	V	0	0	0	0	0	0	0
E1-13	Base Voltage	V	0	0	0	0	0	0	0

For 480V class units, the value is twice that of 240V class units.

Table 7 V/f Pattern Default Settings for Drive Capacity 3 to 40HP for 240V Class

Parameter No.	Name	Unit	Factory Setting							
			0	1	2	3	4	5	6	7
E1-03	V/f Pattern Selection	—	0	1	2	3	4	5	6	7
E1-04	Max. Output Frequency	Hz	50.0	60.0	60.0	72.0	50.0	50.0	60.0	60.0
E1-05	Max. Output Voltage	V	240.0	240.0	240.0	240.0	240.0	240.0	240.0	240.0
E1-06	Base Frequency	Hz	50.0	60.0	50.0	60.0	50.0	50.0	60.0	60.0
E1-07	Mid. Output Frequency A	V	2.5	3.0	3.0	3.0	25.0	25.0	30.0	30.0
E1-08	Mid. Output Voltage A	V	16.1	16.1	16.1	16.1	40.2	57.5	40.2	57.5
E1-09	Min. Output Frequency	Hz	1.3	1.5	1.5	1.5	1.3	1.3	1.5	1.5
E1-10	Mid. Output Voltage	V	8.0	8.0	8.0	8.0	6.9	8.0	6.9	8.0
E1-11	Mid Output Frequency B	Hz	0	0	0	0	0	0	0	0
E1-12	Mid Output Voltage B	V	0	0	0	0	0	0	0	0
E1-13	Base Voltage	V	0	0	0	0	0	0	0	0

For 480V class units, the value is twice that of 240V class units.

Table 7 V/f Pattern Default Settings for Drive Capacity 3 to 40HP for 240V Class (Continued)

Parameter No.	Name	Unit	Factory Setting						
			8	9	A	B	C	D	F
E1-03	V/f Pattern Selection	—	8	9	A	B	C	D	F
E1-04	Max. Output Frequency	Hz	50.0	50.0	60.0	60.0	90.0	120.0	60.0
E1-05	Max. Output Voltage	V	240.0	240.0	240.0	240.0	240.0	240.0	240.0
E1-06	Base Frequency	Hz	50.0	50.0	60.0	60.0	60.0	60.0	60.0
E1-07	Mid. Output Frequency A	V	2.5	2.5	3.0	3.0	3.0	3.0	3.0
E1-08	Mid. Output Voltage A	V	20.7	26.4	20.7	26.4	16.1	16.1	16.1
E1-09	Min. Output Frequency	Hz	1.3	1.3	1.5	1.5	1.5	1.5	1.5
E1-10	Mid. Output Voltage	V	10.3	12.6	10.3	14.9	8.0	8.0	8.0
E1-11	Mid Output Frequency B	Hz	0	0	0	0	0	0	0
E1-12	Mid Output Voltage B	V	0	0	0	0	0	0	0
E1-13	Base Voltage	V	0	0	0	0	0	0	0

For 480V class units, the value is twice that of 240V class units.

Table 8 V/f Pattern Default Settings for Drive Capacity 50 to 150HP for 240V Class

Parameter No.	Name	Unit	Factory Setting							
			0	1	2	3	4	5	6	7
E1-03	V/f Pattern Selection	—	0	1	2	3	4	5	6	7
E1-04	Max. Output Frequency	Hz	50.0	60.0	60.0	72.0	50.0	50.0	60.0	60.0
E1-05	Max. Output Voltage	V	240.0	240.0	240.0	240.0	240.0	240.0	240.0	240.0
E1-06	Max. Voltage Frequency	Hz	50.0	60.0	50.0	60.0	50.0	50.0	60.0	60.0
E1-07	Mid. Output Frequency A	V	2.5	3.0	3.0	3.0	25.0	25.0	30.0	30.0
E1-08	Mid. Output Voltage A	V	13.8	13.8	13.8	13.8	40.2	57.5	40.2	57.5
E1-09	Min. Output Frequency	Hz	1.3	1.5	1.5	1.5	1.3	1.3	1.5	1.5
E1-10	Mid. Output Voltage	V	6.9	6.9	6.9	6.9	5.7	6.9	5.7	6.9
E1-11	Mid Output Frequency B	Hz	0	0	0	0	0	0	0	0
E1-12	Mid Output Voltage B	V	0	0	0	0	0	0	0	0
E1-13	Base Voltage	V	0	0	0	0	0	0	0	0

For 480V class units, the value is twice that of 240V class units.

Table 8 V/f Pattern Default Settings for Drive Capacity 50 to 150HP for 240V Class (Continued)

Parameter No.	Name	Unit	Factory Setting						
			8	9	A	B	C	D	F
E1-03	V/f Pattern Selection	–	8	9	A	B	C	D	F
E1-04	Max. Output Frequency	Hz	50.0	50.0	60.0	60.0	90.0	120.0	60.0
E1-05	Max. Output Voltage	V	240.0	240.0	240.0	240.0	240.0	240.0	240.0
E1-06	Base Frequency	Hz	50.0	50.0	60.0	60.0	60.0	60.0	60.0
E1-07	Mid. Output Frequency A	V	2.5	2.5	3.0	3.0	3.0	3.0	3.0
E1-08	Mid. Output Voltage A	V	17.2	23.0	17.2	23.0	13.8	13.8	13.8
E1-09	Min. Output Frequency	Hz	1.3	1.3	1.5	1.5	1.5	1.5	1.5
E1-10	Mid. Output Voltage	V	8.0	10.3	8.0	12.6	6.9	6.9	6.9
E1-11	Mid Output Frequency B	Hz	0	0	0	0	0	0	0
E1-12	Mid Output Voltage B	V	0	0	0	0	0	0	0
E1-13	Base Voltage	V	0	0	0	0	0	0	0

For 480V class units, the value is twice that of 240V class units.

◆ E2 Motor Setup

■ E2-01 Motor Rated Current

Setting Range: Model Dependent (see Appendix B)

Factory Default: Model Dependent

The Motor Rated Current parameter (E2-01) is necessary information for the Drive motor protection function. The motor overload protection parameter L1-01 is enabled by default. In addition, motor rated current is used by the torque compensation function to insure optimum torque production. Set E2-01 to the full load amps (FLA) value stamped on the motor's nameplate. During Auto-tuning, it is required for the operator to enter the motor rated current in parameter T1-04 on the Auto-Tuning menu. If the Auto-tuning operation completes successfully, the value entered into T1-04 will be also written into E2-01.

For applications employing a Drive that is oversized for the motor, E2-01 may be set as low as 10% of the Drive output current rating. The AMP value in E2-01, however, must always be greater than the "No Load Current" value in parameter E2-03 or an OPE02 error will be displayed.

■ E2-03 No Load Current

Setting Range: Model Dependent (see Appendix B)

Factory Default: Model Dependent

Set E2-03 to the motor no-load current at rated voltage and rated frequency. Consult the motor manufacturer for the proper value if the no load current is not stated on the motor nameplate.

■ E2-05 Motor Line-to-Line Resistance

Setting Range: 0.0000 to 65.000 Ω

Factory Default: 9.842 Ω

Sets the line-to-line resistance of the motor's stator winding. Usually determined by performing Auto-tuning. If Auto-tuning cannot be completed without error, then manually set E2-05 to the value as determined by the motor manufacturer. Remember this value must be entered as line-line and not line neutral.

$$E2-05 = \left(\frac{\text{Phase-to-phase Resistance at}}{\text{Insulation Class Temperature}} \right) \times \frac{273 + (25 + \text{insulation class temperature}) / 2}{273 + \text{insulation class temperature}}$$

Where: Insulation class temperature is in °C

◆ F6 Com OPT Setup (applies only to the LonWorks option)

■ F6-01 Operation Selection After Communication Error

Setting	Description
0	Ramp to Stop
1	Coast to Stop (<i>factory default</i>)
2	Fast-Stop
3	Alarm Only

If a serial communication option board is attached to the Drive at the 2CN connector, the Drive will automatically monitor the card for any type of communication errors. F6-01 is applicable no matter whether a run command or speed command is coming via the option board, digital operator, or terminal input. The setting of F6-01 determines whether the communication error is seen as a fault or an alarm. If F6-01= "3: Alarm Only", then the fault output is not energized upon a communication error. All other settings of F6-01 cause the fault output to energize. The setting of F6-01 does not apply to any of the embedded communication protocols used at the RS-485/422 terminals on the removable terminal board. (See parameters H5-0X).

■ F6-02 Option PCB External Fault Detection Selection

Setting	Description
0	Always Detected (<i>factory default</i>)
1	Detected only during operation

■ F6-03 Option PCB External Fault Stopping Method

Setting	Description
0	Ramp to Stop
1	Coast to Stop (<i>factory default</i>)
2	Fast-Stop
3	Alarm Only

If an external fault is received from the LONWORKS® or other communication option card, the settings of F6-02 and F6-03 will determine the Drive operation in reaction to the fault signal. Parameter F6-02 will determine if the external fault is always recognized (F6-02= “0: Always Detected”) or only recognized when the Run command is active (F6-02= “1: Detected only during operation”).

Once the fault is recognized, parameter F6-03 will determine the operation of the Drive. If parameter F6-03 is set to anything other than “3”, the Drive will fault and a stopping sequence is begun. If F6-03= “3: Alarm Only”, then the external fault is treated like an alarm. Operation will continue and an EF0 fault will flash on the digital operator.

■ F6-05 Current Scaling via Communication Option PCB

Setting	Description
0	A Display (<i>factory default</i>)
1	100%/8192 (Drive Rated Current)

A communication option card can read the Drive’s DPRAM to access the current monitor. The format of the current reading in the DPRAM will be determined by parameter F6-05.

F6-05= “0: A Display” → Current is a decimal number corresponding to actual Amperes

F6-05= “1: 100%/8192 (Drive Rated Current)” → Current reading is a number where
8192 = 100% of Drive rated output current

◆ H1 Digital Inputs

■ H1-01 Terminal S3 Function Selection

H1-02 Terminal S4 Function Selection

H1-03 Terminal S5 Function Selection

H1-04 Terminal S6 Function Selection

H1-05 Terminal S7 Function Selection

Setting Range: 0 to 6E

Factory Default: H1-01= “24: External Fault”

H1-02= “14: Fault Reset”

H1-03= “3: Multi-Step Ref 1” (2-Wire)
“0: 3-Wire Control” (3 Wire)

H1-04= “4: Multi-Step Ref 2” (2 Wire)
“3: Multi-Step Ref 1” (3 Wire)

H1-05= “6: Jog Freq Ref ” (2 Wire)
“4: Multi-Step Ref 2” (3 Wire)

The Drive has five multi-function contact digital inputs. By programming parameters H1-01 through H1-06, the user can assign specific functions to each input. Below is a table with a complete list of all of the digital input functions. Following the table is a more detailed description of each of the functions.

Parameter setting	Function	Parameter setting	Function
0	3-Wire Control	1C	Trim Control Increase
1	Local/Remote Selection	1D	Trim Control Decrease
2	Option/Inv Selection 1	1E	Reference Sample Hold
3	Multi-step Reference 1	20-2F	External Fault
4	Multi-step Reference 2	30	Integral Reset
6	Jog Frequency Reference 1	31	Integral Hold
7	Multi-Accel/Decel 1	34	PI Soft Start Cancel
8	External Baseblock N.O.	35	PI Input Characteristic
9	External Baseblock N.C.	36	Option/Inv Selection 2
A	Accel/Decel Ramp Hold	60	Motor Pre-heat
C	Terminal A2 Enable	61	Speed Search 1
F	Terminal Not Used	62	Speed Search 2
10	MOP Increase	64	Speed Search 3
11	MOP Decrease	67	Communications Test Mode
12	Forward Jog	68	High Slip Braking
13	Reverse Jog	69	Jog Frequency Reference 2
14	Fault Reset	6A	Drive Enable
15	Fast Stop N.O.	6B	Comm/Inv Selection
17	Fast Stop N.C.	6C	Com/Inv SEL 2
18	Timer Function	6D	Auto Mode @ Close
19	PI Disable	6E	Hand Mode @ Close
1B	Program Lockout	70	Bypass Drv Enable

Function: 3-Wire Control

Setting: 0

When one of the digital inputs is programmed for 3-Wire control, that input becomes a Forward/Reverse directional input. Whenever the input is open, the Drive will be set for forward rotation of the motor shaft. If the input is closed, then the motor shaft will rotate in the reverse direction whenever there is a Run input. The S1 and S2 digital inputs will function as a Run and Stop input respectively.

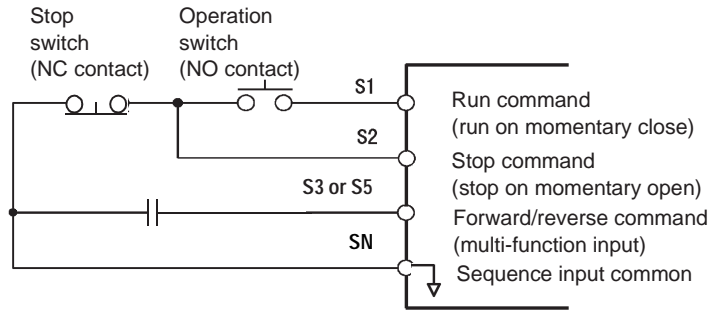

Fig. 30 Terminal Configuration for 3-Wire Control

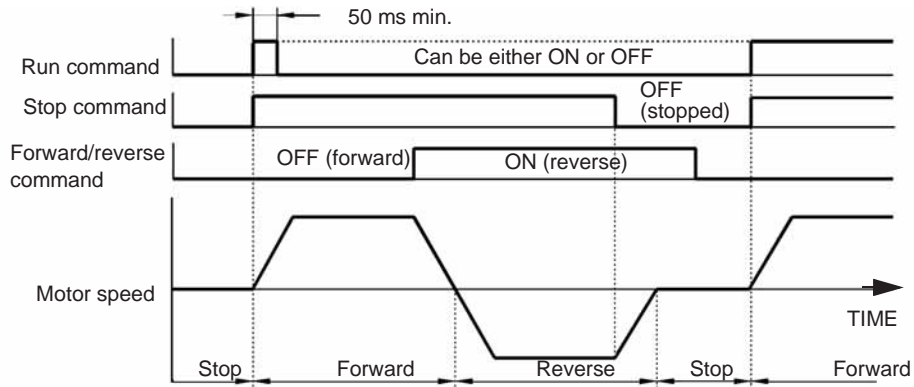

Fig. 31 3-Wire Control Timing Diagram

IMPORTANT

As long as the S1(Run Command) input is applied in for at least 50 ms the Run command will latch internally in the Drive.

Function: Local/Remote Selection

Setting: 1

This function has been disabled. Please refer settings “6D” and “6E”.

Function: Option/Inv Selection 1

Setting: 2

The Option/Inv Selection function allows the user to select the source for the Run and speed commands between either the Drive’s terminals or an optional communication card. When a digital input is programmed for the Option/Inv Selection function (H1-0x= 2) that input will function as follows:

Table 10 Digital Input Functions	
Option/Inv Selection Input Status	Run and Speed Command Source
OPEN	From the control circuit and analog input terminals
CLOSED	From the Communications Option Card

To switch the command source between the option card and the terminals be sure to program the following parameters:

- Set b1-01 (Frequency Reference Selection) to 1 (Terminals).
- Set b1-02 (Run Command Selection) to 1 (Terminals).
- Set H1-0x (Input Terminal Function Selection) to 2.

IMPORTANT | Switching between the different Reference and Run sources can only be done while the Drive is stopped.

Function: Multi-step Ref 1

Setting: 3

Function: Multi-step Ref 2

Setting: 4

The Drive can be programmed to step through four preset speeds and a jog. It is also possible to mix in the analog inputs as speed references that can be chosen in place of the first and second preset frequency references. The selection of which preset speed will be the active speed command is determined by the status of the digital inputs set for Multi-step Ref 1 (H1-0x= 3) and Multi-step Ref 2 (H1-0x= 4). Changing the active speed command via the Multi-step References can be done while the Drive is running.

The following table details which reference is active based on the status of the Multi-step Ref 1 and Multi-step Ref 2 inputs:

Table 11 Digital Input Functions				
Preset Speed	Terminal Programmed as Multi-step Reference 1	Terminal Programmed as Multi-step Reference 2	Terminal Programmed as Jog Reference	Details
1	OFF	OFF	OFF	Frequency Reference 1 (d1-01) or analog input A1 [#] (determined by b1-01)
2	ON	OFF	OFF	Frequency Reference 2 (d1-02) or analog input A2 [#] (determined by H3-09)
3	OFF	ON	OFF	Frequency Reference 3 (d1-03)
4	ON	ON	OFF	Frequency Reference 4 (d1-04)
5	-	-	ON*	Jog Frequency (d1-17)

* The Jog Frequency input is given priority over the multi-step speeds. [#] Shown for H3-13="0: Main Fref TA1"; A1 and A2 are reversed if H3-13="1: Main Fref TA2"

The determination of whether the Preset Speed 1 will be the Frequency Reference 1 (d1-01 or the analog input A1) is determined by the status of b1-01. If b1-01= "1: Terminals", the value of the input to A1 will determine the commanded speed when Preset Speed 1 is selected. If b1-01≠1, the setting of d1-01 will determine the commanded speed when Preset Speed 1 is selected.

The determination of Preset Speed 2 is made much the same way as Preset Speed 1 except that the setting of parameter H3-09 decides whether the analog input A2 or d1-02 is Preset Speed 2. If H3-09= "2: Aux Reference", the value of the input to A2 will determine the commanded speed when Preset Speed 2 is selected. If H3-09≠2, the setting of d1-02 will determine the commanded speed when Preset Speed 2 is selected.

Function: Jog Frequency Reference

Setting: 6

When a digital input configured as Jog Freq Ref (H1-0x= 6) is Closed, the active speed command will be the setting of parameter d1-17 (Jog Frequency Reference). Closure of this digital input alone will not initiate a Jog motion, it will only change the speed command. An active Run input is necessary for actual jogging.

To change to the Jog Speed Command and provide a Run Command, with a single input, please refer to digital input settings "12" and "13".

Function: Multi-Acc/Dec 1

Setting: 7

When a digital input configured as Multi-Acc/Dec 1 (H1-0x= 7) is OPEN the first set of acceleration/deceleration times (C1-01 and C1-02) are active.

When a digital input configured as Multi-Acc/Dec 1 (H1-0x= 7) is CLOSED the second set of acceleration/deceleration times (C1-03 and C1-04) are active.

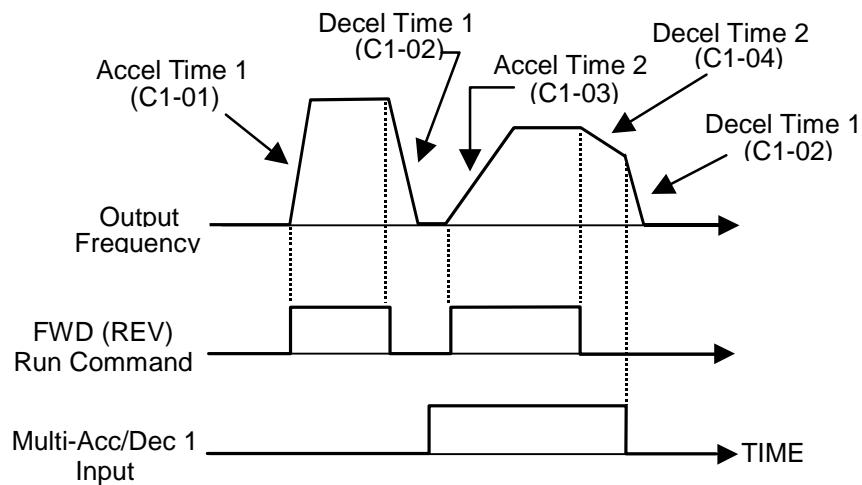

Fig. 32 Multi-Accel/Dec Timing Diagram

Function: Ext Baseblk N.O.
Setting: 8

Function: Ext Baseblk N.C.
Setting: 9

When the Drive is commanded into baseblock, gating of the output transistor stops and output voltage/frequency drops to zero (motor coasts). The Drive can be forced into a baseblock state by either closing a digital input configured for Ext Baseblk N.O. (H1-0x= 8) or opening a digital input configured for Ext Baseblk N.C. (H1-0x= 9).

When the baseblock state is removed the speed search function is used to catch the coasting motor and ramp it back to the commanded speed.

The method of speed search, Current Detection or Speed Estimation, that is utilized when the baseblock input is removed depends on the setting of parameter b3-01:

If b3-01= "0: SpdsrchF Disable" or "1: SpdsrchF Enable"; Speed Estimation is used

If b3-01= "2: SpdsrchI Disable" or "3: SpdsrchI Enable"; Current Detection is used

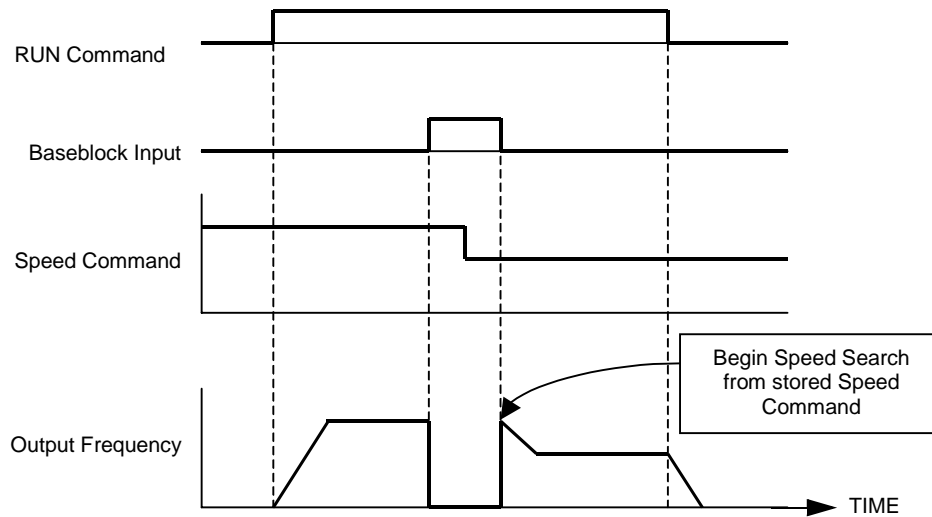

Fig. 33 External Baseblock Characteristics

Function: Acc/Dec RampHold

Setting: A

The Acc/Dec RampHold function will clamp (“hold”) the speed of the output frequency whenever a digital input that has been programmed for it (H1-0x= A) is closed. All acceleration or deceleration will stop and the Drive will hold the current speed. Once the input is opened, acceleration or deceleration continues.

The Acc/Dec RampHold function is affected by parameter d4-01. If d4-01= “1: Enabled” and the Acc/Dec RampHold functions are both being used, whenever the RampHold input is closed the output frequency is memorized. When interrupted power is returned and a Run command is input, the Speed Command will be the last output frequency memorized by the Acc/Dec RampHold function, if the Acc/Dec RampHold input is still closed.

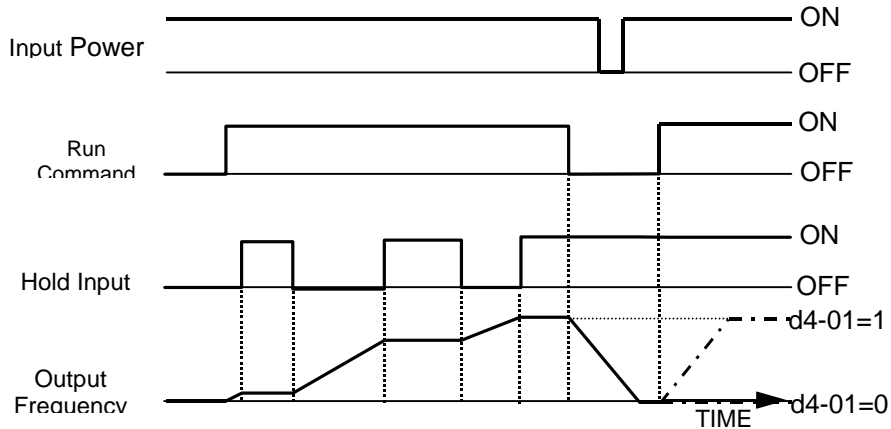

Fig. 34 Accel/Dec RampHold Function Timing Diagram

Function: Term A2 Enable

Setting: C

Any digital input configured as Term A2 Enable (H1-0x= C) when open will cause the input to analog input A2 to be ignored.

If analog input A2 is configured as the Main Reference (H3-13= “1: Main Fref TA1”), then the Term A2 Enable input will have no effect.

Function: Term Not Used

Setting: F

Any digital input programmed as Term Not Used (H1-0x= F) will have no function assigned to it and it’s OPEN/CLOSED state will not matter to the Drive’s operation.

Function: MOP Increase

Setting: 10

Function: MOP Decrease

Setting: 11

Using two digital inputs, the Drive can operate with the same type of functionality as a motor operated potentiometer (MOP). One digital input can be programmed as an MOP Increase input (H1-0x= 10) and another digital input can be programmed as an MOP Decrease input (H1-0x= 11). This MOP functionality is also commonly referred to as Floating Point Control, Incremental Control or UP and DOWN Control since closing the MOP Increase input will cause the speed command to increase and closing the MOP Decrease input will cause the speed command to decrease.

If both the MOP Increase and the MOP Decrease are closed or open simultaneously, the speed will command will not change. The speed command will change at the active acceleration or deceleration rate.

MOP Increase cannot be programmed without also programming the MOP Decrease (or vice versa) else an OPE03 fault will occur. Setting the MOP Increase/Decrease function while the Acc/Dec RampHold function is programmed into other digital inputs will also cause an OPE03 fault.

Once the MOP function is programmed the preset speeds are disabled and the analog speed command input becomes a potential frequency reference lower limit. The lower limit of the MOP function is the greater of the analog speed command and the programmed frequency reference lower limit (d2-03). Once a Run command is issued the Drive will accelerate immediately to the lower limit. The upper limit will be the Frequency Reference Upper Limit (d2-01), if used, otherwise the Maximum Frequency (E1-04).

The status of the d4-01 parameter (MOP Reference Memory) will affect the performance of the Drive after power is cycled to the Drive and a fresh Run command is issued. If d4-01= "0: Disabled", the Run command will cause the Drive to ramp to the frequency reference lower limit. However, if d4-01= "1: Enabled", the Run command will cause the Drive to ramp to the last speed commanded by the MOP function before the Run command was removed and the power cycled. Even if d4-01= "1: Enabled", the previous speed command can be reset to the frequency reference lower limit automatically by closing either the UP or Down input without having a Run command active.

IMPORTANT

Be sure to set b1-01= "1: Terminals", (Speed Command Source =Terminals) if the MOP function is to be used. If b1-01= "0: Operator", then the MOP is disabled even if it is programmed. The Jog inputs have priority over the MOP function.

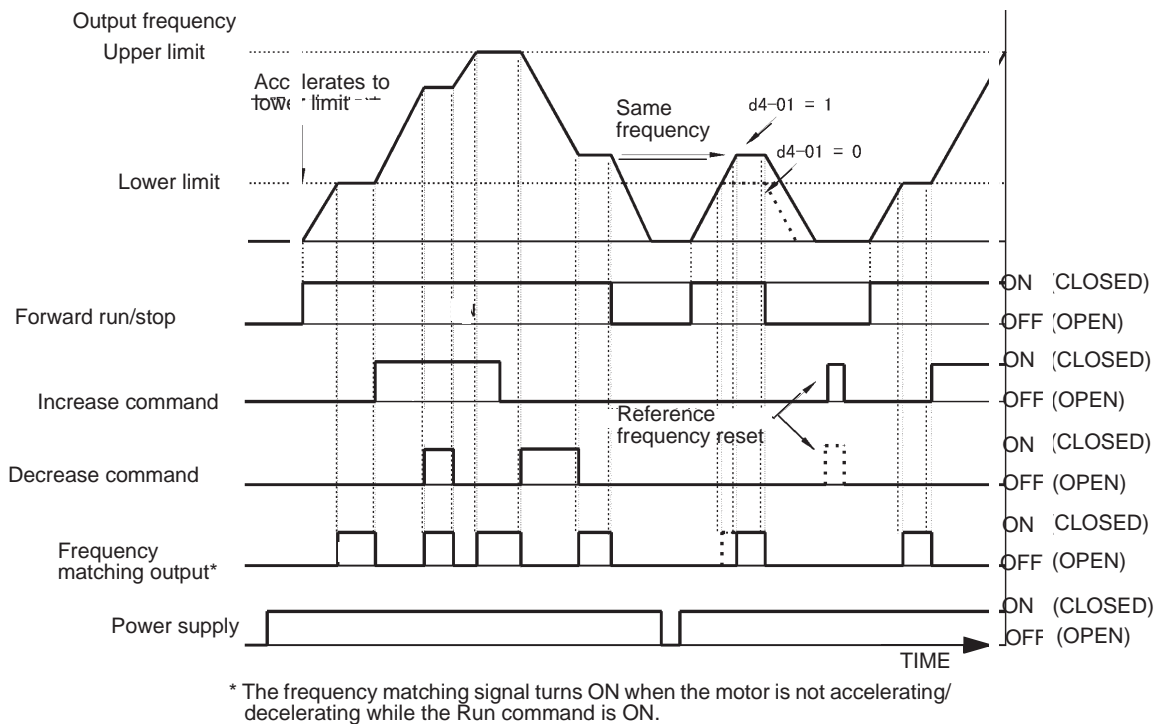

Fig. 35 Floating Point Control Time Chart

Function: Forward Jog

Setting: 12

Function: Reverse Jog

Setting: 13

Digital inputs programmed as Forward Jog (H1-0x= 12) and Reverse Jog (H1-0x= 13) will be Jog inputs that do not require a Run command. Closing the Forward Jog input will cause the Drive to ramp to the Jog Frequency Reference (d1-17) in the Fwd direction. The Reverse Jog will cause the same action in the Rev direction. The Forward Jog and Reverse Jog can be set independently.

The Forward and Reverse Jog inputs will have priority over other frequency references but the Reverse Jog input will not function if Reverse Operation is disabled (b1-04= "1: Reverse Disabled" or "3: ExchgPhs, Rev Dsbl").

If both the Forward Jog and Reverse Jog are input simultaneously for 500 ms or more an external fault will occur and the Drive will stop, using the method set by b1-03.

Function: Fault Reset

Setting: 14

Whenever the Drive detects a fault condition, the fault output contact will close and the Drive's output will shut OFF causing the motor to coast (specific stopping methods can be selected for some faults such as L1-04 for motor overheat). Once the Run command is removed, the fault can be reset by either the RESET key on the digital operator or by closing a digital input configured as a Fault Reset (H1-0x= 14).

Function: Fast Stop N.O.

Setting: 15

Function: Fast Stop N.C.

Setting: 17

The Fast Stop function operates much like an emergency stop input to the drive. While in the Run mode, if a Fast Stop is input to the Drive (CLOSED for H1-0x= 15 or OPEN for H1-0x= 17), the Drive will decelerate to a stop with the deceleration time determined by C1-09 (Fast Stop Time). The Run command can remain closed during the Fast Stop operation. The Drive will not run, from either the terminals or the digital operator, while the Fast Stop is being input to the Drive. To restart the Drive, the Fast Stop input must be removed and the Run command must be cycled.

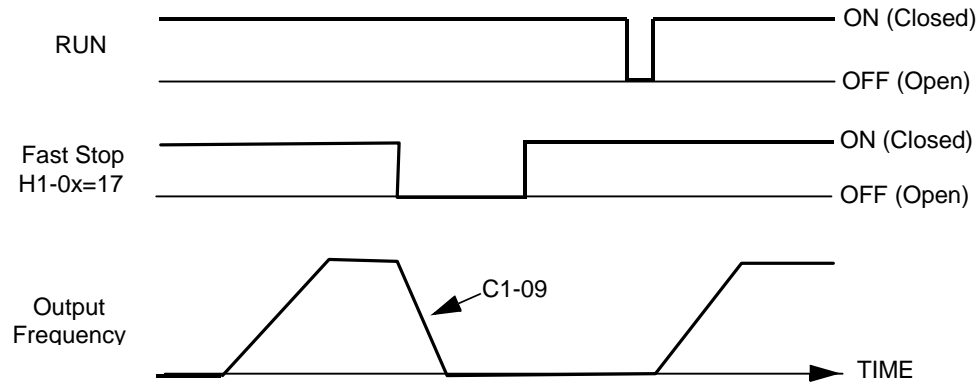

Fig. 36 Fast Stop Commands Time Chart

IMPORTANT

Be aware that during rapid deceleration the Drive may fault on an over voltage condition. When faulted, the Drive output shuts off allowing the motor to coast. The result is an uncontrolled motor state. Therefore, be sure to set an acceptable deceleration time in parameter C1-09 when using the fast stop feature.

Function: Timer Function

Setting: 18

The Timer Function works independently from the Drive. For Timer operation a digital input must be configured for a Timer Function start (H1-0x= 18), a digital output must be configured as a Timer Function output (H2-0x= 12), and the Timer Function ON-Delay and OFF-Delay parameters (b4-01 and b4-02, respectively) must be programmed.

Once the applicable parameter are programmed the Timer Function start digital input must be closed at least as long as the setting of b4-01 before the Timer Function output will close. The Timer Function input must be open for at least as long as the setting of b4-02 before the Timer Function output will reopen.

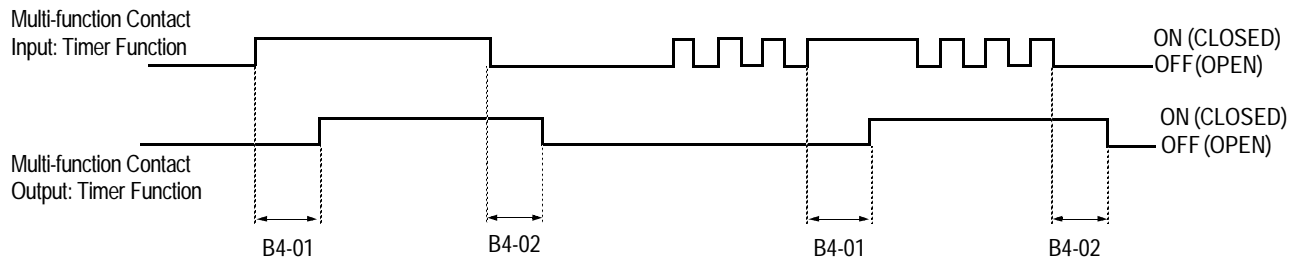

Fig. 37 Timer Function Time Chart

Function: PI Disable

Setting: 19

When the PI Function has been enabled by b5-01 (PI Mode Selection), it can be indefinitely disabled by closing a digital input configured as a PI Disable input (H1-0x= 19). When disabled, the Drive operates as a standard drive that does not have PI enabled

Function: Program Lockout

Setting: 1B

A Program Lockout digital input will allow changing of parameter values when it is open but prevent changing of any Drive parameter value except the Speed Command when it is closed. Parameter values can be viewed even when a Program Lockout is active.

Function: TrimCtl Increase

Setting: 1C

Function: TrimCtl Decrease

Setting: 1D

The TrimCtl Increase and TrimCtl Decrease cannot be set independently. An OPE03 fault will occur if one is configured without the other. Once both are configured they can be used to trim the Speed Command by adding or subtracting a set frequency (d4-02) from the currently commanded speed. Once the input is cleared the Speed Command will return to the pre TrimCtl level. Refer to Figure 28.

The TrimCtl Function is not effective when the Speed Command is coming from the digital operator.

Function: Ref Sample Hold

Setting: 1E

The Ref Sample Hold function will allow the user to sample an analog signal being input to either A1 or A2 and change the Speed Command to the sampled level. Once the digital input that is configured for the Ref Sample Hold function (H1-0x= 1E) is held for at least 100 ms, the Drive reads the analog input and changes the Speed Command to the newly sampled speed. If the digital input is not held for at least 100 ms, the analog input will not be sampled.

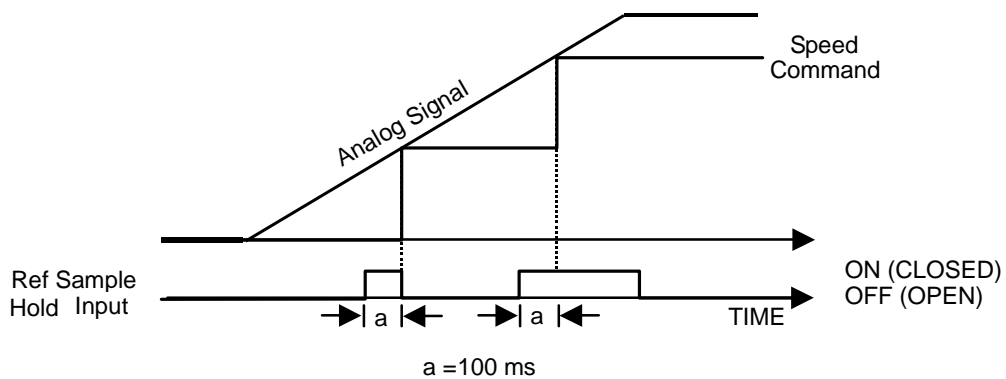

Fig. 38 Reference Sample Hold Time Chart

The Ref Sample Hold function cannot be programmed at the same time as the following digital input functions:

- Acc/Dec RampHold
- MOP Increase/Decrease
- TrimCtl Increase/Decrease

Doing so will cause an OPE03 fault to occur.

Cycling the input power will erase the sampled analog reference and the Speed Command will begin again from zero.

Function: External Fault

Setting: 20 through 2F

External Fault functionality can be programmed into the digital inputs of the Drive. The External Fault inputs can be used to signal to the Drive that other equipment related to the operation of the Drive has experienced problems. If the External Fault is input to the Drive the digital operator will display:

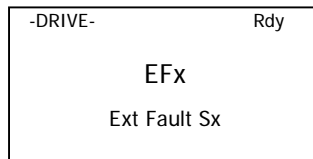

with the x in EFx and Sx represent the terminal number of the digital input that the fault was received on.

To program an External Fault the value input into the H1-0x parameter will determined by:

- Contact type wired to the terminal (Normally Open or Normally Closed)
- Detection profile (Always Detected or Only Detected while Running)
- Drive operation after fault (Stopping Method or Continue Operation)

The following table shows the programming choices.

Set Value	Input Contact Type		Detection Mode		Stopping Method			
	N.O. contact	N.C. contact	Always Detected	Detected while Running	Decel to stop (major fault)	Coast to stop (major fault)	Fast stop (major fault)	Continue operation (minor fault)
20	X		X		X			
21		X	X		X			
22	X			X	X			
23		X		X	X			
24	X		X			X		
25		X	X			X		
26	X			X		X		
27		X		X		X		
28	X		X				X	
29		X	X				X	
2A	X			X			X	
2B		X		X			X	
2C	X		X					X
2D		X	X					X
2E	X			X				X
2F		X		X				X

Function: PI Integral Reset

Setting: 30

By configuring one of the digital inputs as an Integral Reset Input, (H1-0x= 30), the value of the integral component of PI control can be reset to zero whenever the configured input is CLOSED. The integral component of PI control will be held at zero as long as the configured digital input is held CLOSED.

Resetting the Integral component of PI control can be useful in cases where an excessively large Integral value prevents the PI control from responding quickly to changes in the system being regulated by the Drive (e.g. duct pressure, water temperature).

Function: PI Integral Hold

Setting: 31

By configuring a digital input as an Integral Hold input (H1-0X= 31), the value of the Integral component of the PI control can be forced to clamp at the value it was at when the input is CLOSED. The Integral component of the PI control returns to accumulating error when the digital input is OPEN again.

Holding the Integral Value can be useful during periods when the error can build up naturally, such as during long accelerations. Not allowing Integral windup produces a more stable PI control.

Function: PI SFS Cancel

Setting: 34

SFS means softstart, also referred to as accel/decel in this description.

By configuring a digital input as a PI SFS (softstart) Cancel input (H1-0x= 34), the operator will be able to use a contact closure to remove the acceleration and deceleration times that are applied to changes in the PI setpoint by the b5-17 parameter. If the digital input configured as PI SFS Cancel is closed, the PI setpoint Accel/Decel (Parameter b5-17) will be ignored. Immediate updating of any change to the setpoint will apply.

Function: Input Level Sel

Setting: 35

When using the PI Function built into the Drive, the chosen set point is compared with the measured feedback. The difference is called the Error. The proportional and integral function are applied to this error. For some applications it may be appropriate to invert the input to the PI block. This can be accomplished by setting one of the digital inputs up as an Input Level Sel (H1-0x=35). When an Input Level Sel digital input is closed the Error will be inverted before it is passed to the PI block.

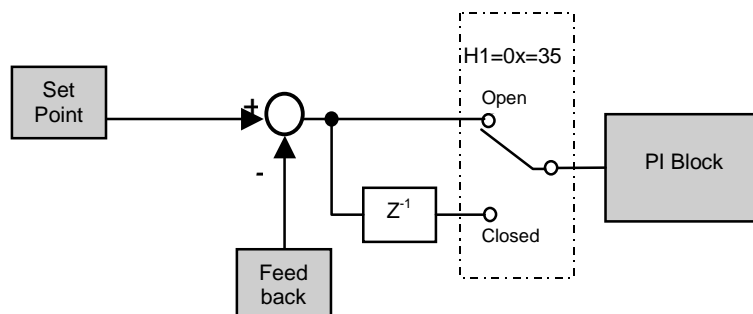

Fig. 39 PI Error signal Inversion Block Diagram

Function: Option/Inv Sel 2

Setting: 36

The Option/Inv Selection function allows the user to switch the source of the Run and speed command between the Drive's terminals and optional communication card. When a digital input is programmed for the Option/Inv Selection 2 function (H1-0x= 36) that input will function as follows:

Table 13 Programming Choices	
Option/Inv Function Input Status	Run and Speed Command Source
OPEN	From the Communications Option Card
CLOSED	From the control circuit and analog input terminals

To switch the command source between the option card and the terminals be sure to program the following parameters:

- Set b1-01 (Frequency Reference Selection) to 1 (Terminals).
- Set b1-02 (Run Command Selection) to 1 (Terminals).
- Set H1-0x (Input Terminal Function Selection) to 36.

IMPORTANT

Switching the Reference and RUN sources can only be done while the Drive is stopped.

Function: Motor Pre-heat

Setting: 60

In order to prevent condensation on the motor windings, a DC current can be circulated through the windings. The heat produced by the current in the windings will prevent the moisture from condensation on the wire. Motor pre-heating can only be initiated by closing a digital input programmed as a Motor Pre-heat input (H1-0x= 60). The level of the DC current used by the Motor Pre-heat function is determined by parameter b2-09.

A Run input will be given priority over a Motor Pre-heat input. When the Run command is removed, if the Motor Pre-heat input is still closed, the motor pre-heating will resume.

Function: Speed Search 1

Setting: 61

Function: Speed Search 2

Setting: 62

Function: Speed Search 3

Setting: 64

Table 14 Digital Input Functions	
Setting of b3-01	Speed Search Method Used for Multi-function inputs
0	Speed Estimation
1	
2	Current Detection
3	

The Speed Search function can be turned on for all starts with parameter b3-01. If, however, it is beneficial to only use Speed

Search at certain starts, a digital input can be programmed to turn on Speed Search only when it is closed. Speed Search 1 will start searching for the rotor speed from the maximum frequency (E1-04). Speed Search 2 will begin searching for the rotor speed from the existing Speed Command. Speed Search 3 will cause the motor to baseblock when the switch is open and then perform Speed Search when it closes.

In all cases the form of Speed Search, Speed Estimation or Current Detection, is determined by the setting of b3-01. If b3-01= “0: SpdsrchF Disable”, then the Speed Estimation form of Speed Search is used. If b3-01= “2: SpdsrchI Disable”, then the Current Detection form of Speed Search is used.

Function: Comm Test Mode
Setting: 67

The Drive has a built-in function for self-diagnosing the serial communications operation. The test involves wiring the send and receive terminals of the RS-485/422 port together. The Drive transmits data and then confirms the communications are received normally.

In order to perform the serial communications self-diagnosis, terminal S7 must be programmed as the Comm Test Mode digital input (H1-05= “67: Com Test Mode”) and then power removed from the Drive and the following steps performed:

1. Wire the S7 and SC terminals of the control circuit terminals together

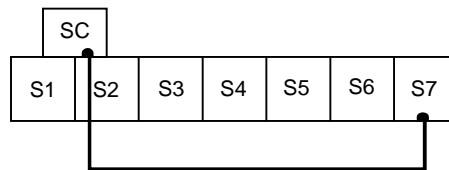

2. Wire the R+ and S+ terminals of the RS-485/422 port together
3. Wire the R- and S- terminals of the RS-485/422 port together

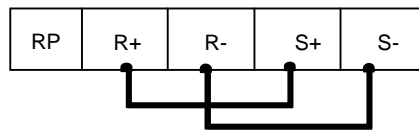

4. Turn On the terminating resistance (Move Switch 1 of Dip Switch 1 to the ON position).

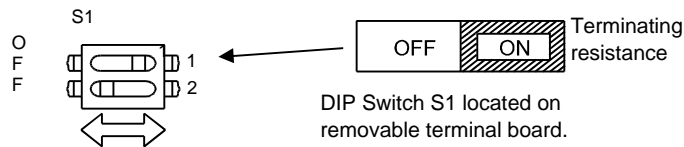

Fig. 40 DIP Switch Setting for Terminating Resistor

5. Turn on power to the Drive.

After step 5 above the Drive will either display “Pass” if everything is okay or a CE alarm will be displayed. If the CE alarm occurs, the fault output contact will energize.

Function: HighSlipBraking

Setting: 68

A digital input can be configured as a High Slip Braking (HSB) command (H1-0x= 68). The HSB feature is intended to be used in applications where the load is high inertia and actual stopping time is not critical. The HSB feature does not “brake” the motor at a predetermined rate, but rather, creates a braking effect based on applied voltage and frequency to the motor. The result is reduced deceleration time as compared to a coasting load, yet the actual deceleration time is unknown (trial and error basis). The HSB feature does not require braking resistors. When the High Slip Braking input is closed during Run mode, the Drive will begin the High Slip Braking function. A braking time can be achieved that is approximately 50% of the time required to decelerate the load normally even without using braking resistors. The High Slip Braking function cannot be exited until the Drive is completely stopped.

The High Slip Braking function manipulates the output frequency while monitoring the output current and DC Bus to create a large slip condition. The regenerative energy caused by the shortened stopping is changed to heat by the motor windings. The increased motor heating limits the HSB duty cycle to 5% and stopping time should be limited to 90 seconds or less.

Function: Jog2

Setting: 69

The Jog2 function applies to 3-Wire control only. If a digital input is configured as Jog2 (H1-0x= 69) when the drive is not in 3-Wire Control, an OPE03 fault will occur.

The Jog2 input will cause the Drive to ramp to the Jog Frequency Reference (d1-17) in the direction dictated by the Fwd/Rev input of the 3-Wire Control mode. Accelerating to and from the Jog Frequency Reference will be determined by the active Accel/Decel parameters.

Function: Drive Enable

Setting: 6A

A digital input configured as a Drive Enable input (H1-0x= 6A) will prevent the Drive from executing a Run command until it is closed. When the Drive Enable input is open the digital operator will display:

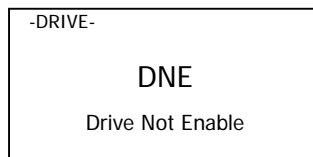

If a Run command is closed prior to the Drive Enable input being closed the Drive will not run until the Run command is cycled.

If the Drive Enable input is opened while the Drive is running, the Drive will stop, using the method set by parameter b1-03.

Function: Com/Inv Sel

Setting: 6B

Function: Com/Inv Sel 2

Setting: 6C

The Com/Inv Selection function allows the user to switch the origin of the Run and speed command between the Drive’s terminals and the RS-485/422 port (and the embedded communication protocols) on the removable terminal board. When a digital input is programmed for the Com/Inv Selection function (H1-0x= 6B) that input will function as follows:

Table 15 6B, COM/INV SEL	
Option/Inv Function Input Status	Run and Speed Command Source
OPEN	From the control circuit and analog input terminals (follows b1-01)
CLOSED	From Serial Comm port (R+,R-,S+, and S-) (embedded protocols)

To switch the command source between the serial communication port and the control circuit terminals be sure to program the following parameters:

- Set b1-01 (Frequency Reference Selection) to 1 (Terminals).
- Set b1-02 (Run Command Selection) to 1 (Terminals).
- Set H1-0x (Input Terminal Function Selection) to 6B or 6C.

The Com/Inv Sel 2 function will operate the same way except the logic is reversed. When a digital input is programmed for the Com/Inv Selection function (H1-0x= 6C) that input will function as follows:

Table 16 6C, COM/INV SEL 2	
Option/Inv Function Input Status	Run and Speed Command Source
OPEN	From Serial Comm port (R+, R-, S+, and S-) (embedded protocols)
CLOSED	From the control circuit and analog input terminals (follows b1-01)

IMPORTANT

Switching the Reference and Run sources can only be done while the Drive is stopped.

Function: Auto Mode Sel

Setting: 6D

Function: Hand Mode Sel

Setting: 6E

The 6E setting for digital input defines the speed command (or setpoint) source as the keypad/operator for a closed contact and allows b1-01 to determine the speed command source for an open contact.

Input Contact Status	Speed Command or PI Setpoint Source
OPEN	Determined by b1-01
CLOSED	Keypad/operator (override b1-01)

This effects the speed command (reference) input only. The Auto Mode Selection (H1-0x=6D) and the Hand Mode Selection (H1-0x-6E) allows use of a digital input to toggle between the Auto and Hand operational modes for speed control. The Auto Mode Selection and Hand Mode Selection cannot both be programmed simultaneously. If both 6D and 6E are programmed together, an OPE03 fault will occur.

The 6D setting for digital input defines the speed command (or setpoint) source as the keypad/operator for an open contact and allows b1-01 to determine the speed command source for a closed contact. Setting 6D has no effect on the run command.

Input Contact Status	Speed Command or PI Setpoint Source
OPEN	Keypad/operator (override b1-01)
CLOSED	Determined by b1-01

Function: Bypass Drv Enbl

Setting: 70

A digital input configured as a Bypass Drive Enable input (H1-0x= 70) will prevent the Drive from executing a Run command until the Bypass Drive Enable input is closed. When the Bypass Drive Enable input is open and a Run command is closed, the digital operator will display:

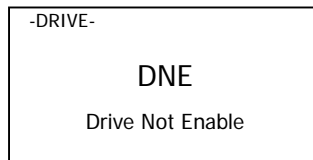

Unlike the Drive Enable digital input function (H1-0x= 6A) that requires the run command to be cycled (removed then reapplied) if the Run command was applied prior to the Drive enable input, the Run command does not need to be cycled after the Bypass Drive Enable input is closed. The Drive will run anytime both the Run and Bypass Drive Enable inputs are both closed.

If the Bypass Drive Enable input is opened while the Drive is Running, the Drive will stop, using the method set by parameter b1-03.

◆ H2 Digital Outputs

■ H2-01 Terminal M1-M2 Function Selection

H2-02 Terminal M3-M4 Function Selection

Setting Range: 0 to 3B

Factory Default: H2-01= “0: During Run 1”

H2-02= “A: Remote/Auto Oper”

The Drive has two multi-function outputs. By programming parameters H2-01 and H2-02, the user can assign specific functions to each output. Below is a table with a complete list of all of the digital output functions. Following the table is a more detailed description of each of the functions.

Parameter setting	Function	Parameter setting	Function
0	During Run1	E	Fault
1	Zero Speed	F	Terminal Not Used
2	F _{REF} /F _{OUT} Agree 1	10	Minor Fault
3	F _{REF} /Set Agree 1	11	Reset Cmd Active
4	Frequency Detect 1	12	Timer Output
5	Frequency Detect 2	17	Torque Detect 1 N.C.
6	Drive Ready	1A	Reverse Direction
7	DC Bus Undervoltage	1E	Restart Enabled
8	Baseblock 1	1F	Overload (OL1)
9	Option Reference	20	OH Pre-alarm
A	Remote Operation	38	Drive Enable
B	Torque Detect 1 N.O.	39	Drive Waiting
C	Loss of Reference	3A	Frequency Reduced, OH
		3B	Run from Serial Com

Function: During Run 1

Setting: 0

A “During Run 1” output will close whenever the Run command is provided and the Drive is outputting voltage. This will include deceleration and DC Injection.

Function: Zero Speed

Setting: 1

The “Zero Speed” output will close whenever the output frequency falls below the Minimum Frequency (E1-09).

Function: Fref/Fout Agree 1

Setting: 2

The “Fref/Fout Agree 1” output will close whenever the actual output frequency is within the Speed Agree Width (L4-02) of the current Speed Command regardless of the direction.

Function: Fref/Set Agree 1

Setting: 3

The “Fref/Set Agree 1” output will close whenever the actual output frequency and the Speed Command are within the Speed Agree Width (L4-02) of the programmed Speed Agree Level (L4-01).

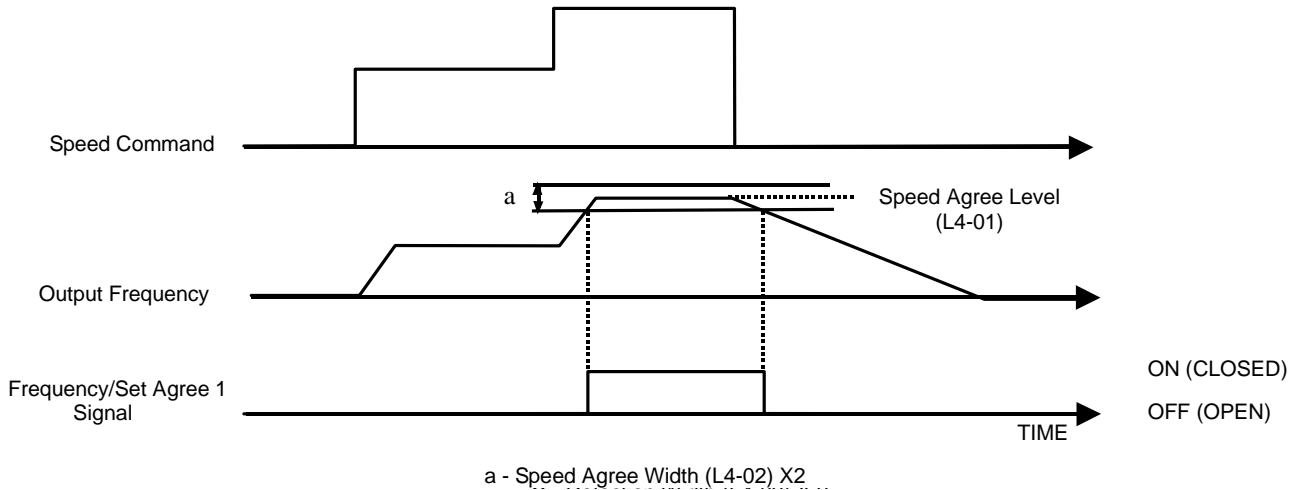

Fig. 41 Fref/Set Agree 1 Timing Diagram

Function: Freq Detect 1

Setting: 4

A “Freq Detect 1” output will be closed whenever the output frequency is equal to or below the value of the programmed Speed Agree Level (L4-01). The Speed Agree Width (L4-02) is the hysteresis to the Freq Detect 1 function. Whenever the output frequency approaches the Speed Agree Level while accelerating it will need to be equal to or exceed the Speed Agree Level (L4-01) plus the Speed Agree Width (L4-02) before the Freq Detect 1 output will energize.

As the output frequency approaches the Speed Agree Level while decelerating, the Freq Detect 1 output will de-energize exactly at the Speed Agree Level.

The Freq Detect 1 function is effective during both forward and reverse operation.

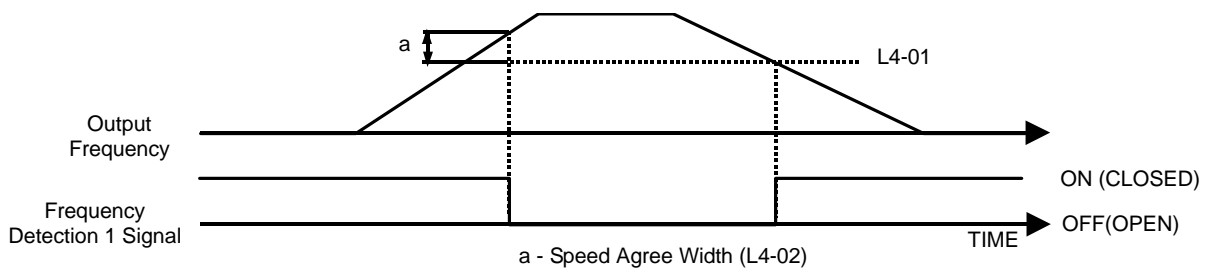

Fig. 42 Freq Detect 1 Timing Diagram

Function: Freq Detect 2

Setting: 5

A Freq Detect 2 output will be closed whenever the output frequency is equal to or above the value of the programmed Speed Agree Level (L4-01). The Speed Agree Width (L4-02) is the hysteresis to the Freq Detect 2 function. Whenever the output frequency approaches the Speed Agree Level (L4-01) while accelerating it will de-energize exactly at the Speed Agree Level.

As the output frequency approaches the Speed Agree Level while decelerating, the Freq Detect 2 output will de-energize when the output frequency is equal to or below the Speed Agree Level (L4-01) minus the Speed Agree Width (L4-02).

The Freq Detect 2 function is effective during both forward and reverse operation.

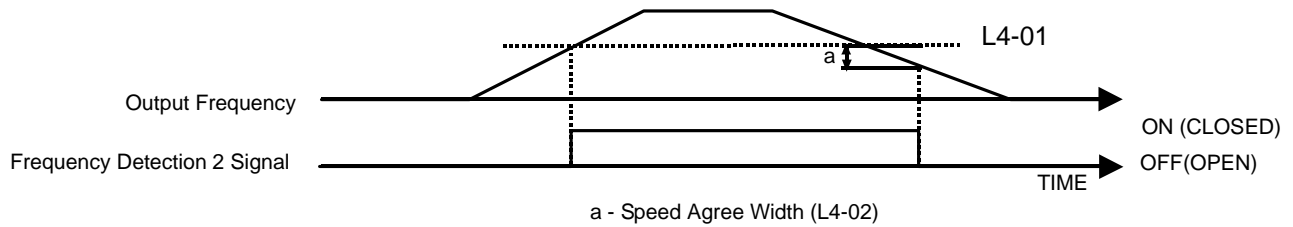

Fig. 43 Freq Detect 2 Timing Diagram

Function: Inverter Ready

Setting: 6

The Inverter Ready output will be closed whenever the Drive is not in a fault state and not being programmed. If b1-08 = “1: Enabled”, a Drive that is in an active Run state that is also being programmed will have the Inverter Ready output closed.

Function: DC Bus Undervolt

Setting: 7

The DC Bus Undervolt output will close whenever the main circuit DC Bus voltage or control circuit power supply drop below their respective trip level. The undervoltage trip level is determined by parameter L2-05. An open soft charge contactor answer back signal will also cause the DC Bus Undervolt output to close.

Function: BaseBlk 1

Setting: 8

A BaseBlk 1 programmed output will close to indicate that the Drive is in baseblocked state. While in a baseblock state the Drive’s output transistors are prevented from firing. A BaseBlk 1 output contact can also serve as notice that the Drive has a charged DC Bus, no fault and can start at any time.

Function: Option Reference

Setting: 9

When an output is configured as an Option Reference output, the output will close to show that the speed command is being sourced from the digital operator. If the Option Reference output is open, it indicates the speed command is coming from the control circuit terminals or an optional communications card.

Function: Remote/Auto Operation

Setting: A

When an output is configured as a Remote Operation output, the output will close to show that the Run command is being sourced from the digital operator. If the Remote Operation output is open, it indicates the Run command is coming from the control circuit terminals or an optional communications card.

Function: Trq Det 1 N.O.

Setting: B

The Trq Det 1 function ties a digital output to the overtorque/undertorque sensing capabilities of the Drive. If a digital output is configured as Trq Det 1 N.O., whenever the output current differs from the level of L6-02 for at least the length of time set in L6-03, the digital output will close.

The torque detection function has a built-in hysteresis of 10% of the Drive rated output current.

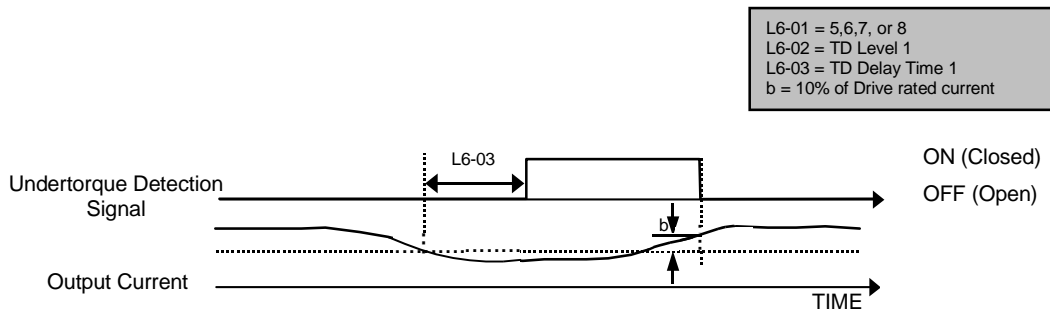

Fig. 44 Trq Det 1 N.O. Timing Diagram

Function: Loss of Reference

Setting: C

The Loss of Reference configured digital output will close when the Drive has detected a loss of the analog speed command. The speed command is considered lost when the voltage level drops 90% in 0.4 seconds. Parameter L4-05 determines the Drive's reaction to a loss of reference state in addition to turning on the Loss of Reference digital output.

The Loss of Reference digital output will only initiate if the Drive is configured for the speed command to be via one of the analog inputs (A1 or A2).

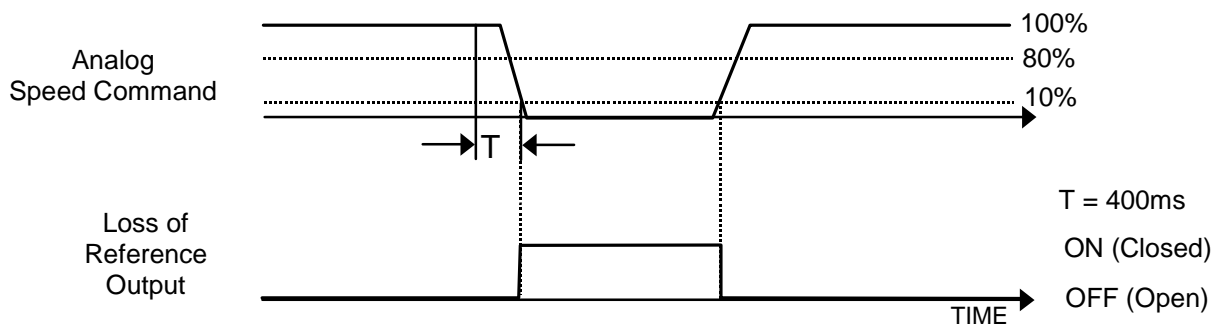

Fig. 45 Loss of Reference Function Characteristics

Function: Fault**Setting: E**

The Fault configured digital output will close whenever the Drive experiences a major fault with the exception of the CPF00 and CPF01 (Digital Operator Communications Faults).

Function: Not Used**Setting: F**

The Not Used setting can be used to disable the digital output.

Function: Minor Fault**Setting: 10**

A Minor Fault, also referred to as an alarm, indicates that a condition exists that may be critical to the Drive or application but does not require the Drive to stop. A minor fault will be flashed on the digital operator but neither the Fault output (MA-MB) nor any digital output configured as a Fault output (H2-0x= E) will close. Any digital output configured as Minor Fault will close whenever a minor fault of alarm condition exists.

Function: Reset Cmd Active**Setting: 11**

A Reset Cmd Active digital output will close to signal that a Fault reset is being attempted from terminals or Serial Com.

Function: Timer Output**Setting: 12**

This Timer function, that is built into the Drive, is independent of the rest of the Drive operation, i.e. there is no requirement for a Run command for the timer to operate. A Timer digital output will close b4-01 seconds after a digital input configured as Timer Input (H1-0x= 18) closes and remains closed. The Timer digital output will remain closed for b4-02 seconds after the Timer digital input opens and remains open.

Refer to the descriptions of parameters b4-01 and b4-02 for a timing chart of the Timer function.

Function: Trq Det 1 N.C.

Setting: 17

The Trq Det 1 function ties a digital output to the overtorque/undertorque sensing capabilities of the Drive. If a digital output is configured as Trq Det 1 N.C., whenever the output current exceeds the level of L6-02 for at least the length of time set in L6-03, the digital output will open.

The torque detection function has a built-in hysteresis of 10% of the Drive rated output current.

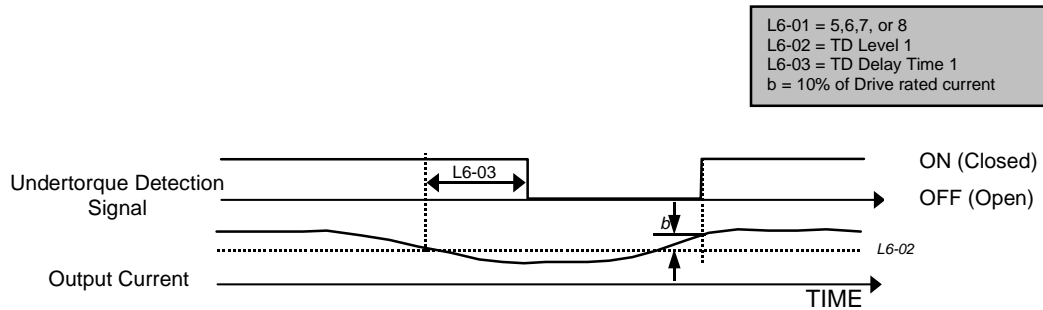

Fig. 46 Trq Det 1 N.C. Timing Diagram

Function: Reverse Dir

Setting: 1A

The Reverse Dir digital output will close whenever the Drive is turning the motor in the direction that corresponds to the reverse direction (CW or CCW). The Reverse Dir digital output will remain closed during deceleration when the rotation is in the reverse direction.

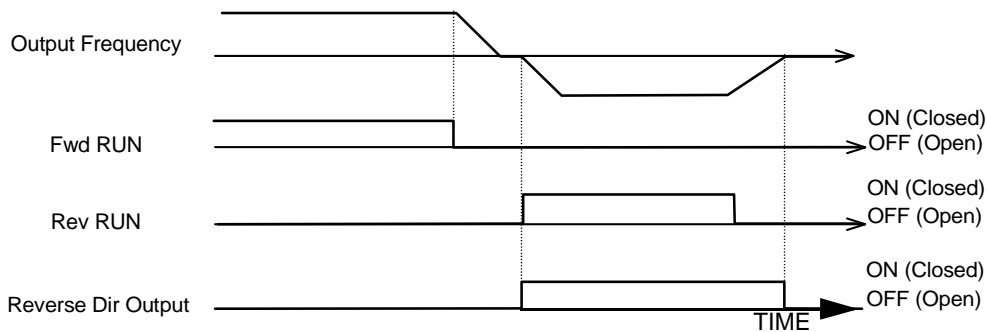

Fig. 47 Reverse Direction Timing Diagram

Function: Restart Enabled**Setting: 1E**

Depending on the setting of parameter L5-01, the Drive may be configured to automatically attempt to restart itself after certain faults. The Restart Enabled output will be closed once the restarts begin and will remain closed until a successful restart is accomplished or the number of Auto Restart attempts as specified by L5-01 is reached.

A timing diagram for the Auto Restart function is contained in the parameter L5-01 description.

Function: Overload (OL1) Alarm**Setting: 1F**

The OL1 fault function is designed to protect the motor. It estimates the motor's winding temperature based on the output current, output frequency, and time. The OL1 time is determined by the setting of parameters E2-01, L1-01, and L1-02. An Overload digital output will close whenever 90% of the programmed OL1 time is exceeded.

Function: OH Prealarm**Setting: 20**

The Overheat fault function (OH) is designed to protect the Drive from excessive temperature damage. Thermistors attached to the heatsink of the Drive monitor the temperature near the devices attached to the heatsink (e.g. input diode modules, output transistor modules) and will fault the drive if the temperature reaches 105°C.

An OH Prealarm digital output will close whenever the heatsink temperature reaches the level specified by parameter L8-02. Parameter L8-03 will determine the Drive's response to reaching the OH Prealarm level, in addition to closing the configured digital output.

Function: Drive Enabled**Setting: 38**

A Drive Enable digital output will reflect the status of a digital input configured as a Drive Enable input (H1-0x= 6A). If the Drive Enable digital input is closed then the Drive Enabled digital output will also close.

Function: Drive Waiting**Setting: 39**

A Drive Waiting digital output will close during the time-out period between the input of a Run command and the expiration of the delay time specified by b1-11.

Function: Frequency Reduced, OH**Setting: 3A**

A Frequency Reduced, OH digital output will close when L8-03 = "4:OH Alarm & Reduce" and an overheat pre-alarm is detected.

Function: Run from Serial Com**Setting: 3B**

A Run from Serial Com digital output will close when the drive run command is from embedded serial com or the com option card.

◆ H3 Analog Inputs

■ H3-02 Terminal A1 Gain Setting

Setting Range: 0.0 to 1000.0%
Factory Default: 100.0%

■ H3-03 Terminal A1 Bias Setting

Setting Range: -100.0% to +100.0%
Factory Default: 0.0%

In order to have the Drive properly interpret an analog input, it may be necessary to apply a gain and/or a bias to the signal. The analog inputs have a resolution of 10 bits (1024 steps). Using the factory default settings for the analog input's gain and bias, the 0-10Vdc or 4-20mA signal at the analog input will yield a 0-100% speed command span.

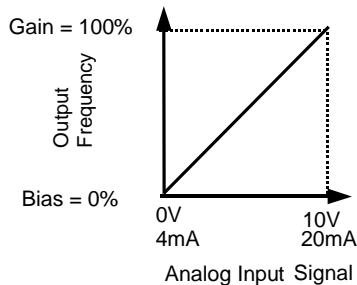

Fig. 48 Output Frequency as Commanded Via Analog Input

If a different span of analog input signal is desirable, it will be necessary to adjust the gain, the bias, or both to allow the analog input level to generate the desired frequency command. Adjustment of the gain setting will change the speed command that is equivalent to the maximum analog input (10Vdc or 20mA). If, for instance, the gain is increased to 200%, then 10Vdc or 20mA will be equivalent to a 200% speed command and 5 VAC or 12mA will be equivalent to a 100% Speed Command. Since the Drive output is limited by the maximum frequency parameter (E1-04), 0-5Vdc or 4-12mA will now be equivalent to 0-100% speed command span.

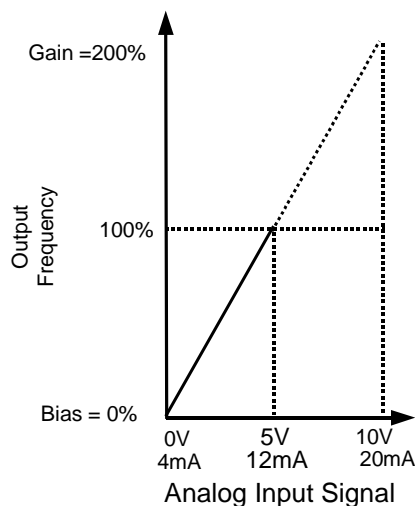

Fig. 49 Output Frequency as Commanded via Analog Input with Increased Gain Setting

Adjustment of the bias setting will likewise adjust the speed command that is equivalent to the minimum analog input level (0Vdc or 4mA). If, for instance, the bias is set to -25%, then 0Vdc or 4mA will be equivalent to a -25% speed command. Since the minimum speed command is 0% an analog input of 2.5 to 10Vdc or 8 to 20mA will now be equivalent to 0-100% speed command span.

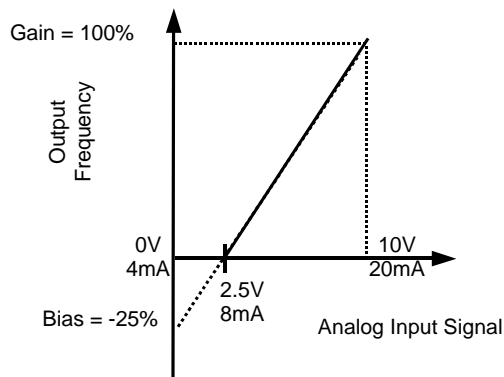

Fig. 50 Output Frequency with Reduced Bias Setting

As a further example, for an inverse-acting speed command, set the bias= 100% and the gain= 0%. The minimum analog input level (0Vdc or 4mA) will produce a 100% speed command and the maximum analog input level (10Vdc or 20mA) will produce a 0% speed command.

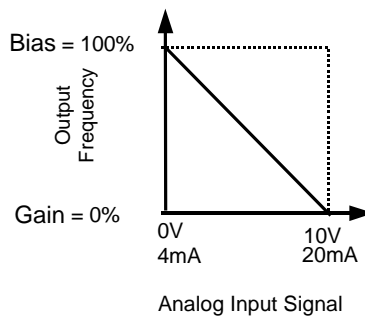

Fig. 51 Output Frequency with Inverted Gain and Bias Settings

■ H3-08 Terminal A2 Signal Level

Setting	Description
0	0 - 10VDC
2	4 - 20mA (Default)

The H3-08 parameter (Terminal A2 Signal Level) allows the programmer to specify the signal that will be applied to the A2 analog input. The A2 analog input can accept either a 0–10 Vdc or 4–20 mA signal as a reference. The Drive also has a DIP switch (S1) on the removable terminal board that must be set for the proper reference signal into the A2 analog input. The S1-2 dipswitch setting determines the internal resistance of the A2 input while parameter H3-08 determines how the Drive interprets the measured signal.

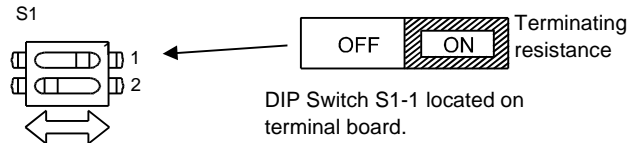
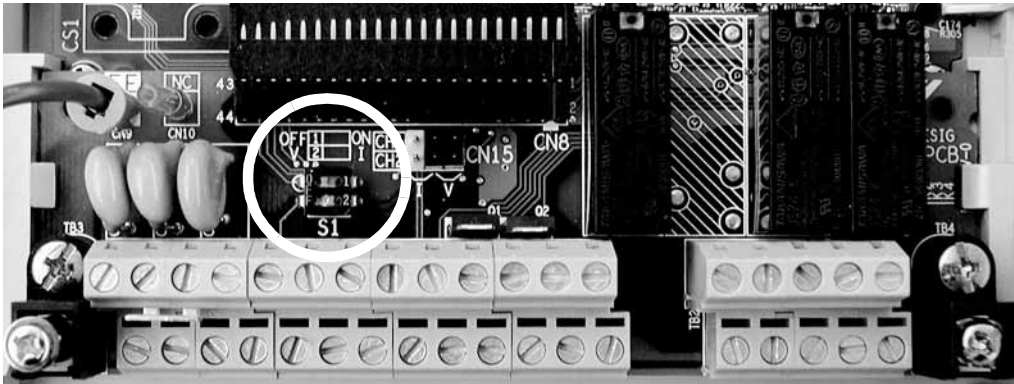

Fig. 52 DIP Switch S1

Table 18 DIP Switch S1		
Name	Function	Setting
S1-1	RS-485 and RS-422 terminating resistance	OFF: No terminating resistance ON: Terminating resistance of 110 Ω
S1-2	Input method for analog input A2	OFF: 0 to 10 V (internal resistance: 20 kΩ) ON: 4 to 20 mA (internal resistance: 250 Ω) (Default)

■ H3-09 Terminal A2 Function Selection

Setting	Description
0	Frequency Bias
2	Aux Reference (<i>factory default</i>)
B	PI Feedback
D	Frequency Bias 2
E	Motor Temperature
16	PI Differential
1F	Not Used

The A2 analog input can be programmed to perform many different functions. The setting of parameter H3-09 determines which of the following functions the A2 analog input will perform.

Function: Frequency Bias

Setting: 0

By setting H3-09= “0: Frequency Bias”, the A2 analog input will serve as a bias signal to the A1 Speed Command. The effect of using A2 for a frequency bias is that the level of the A2 analog input will be summed with the level of the Speed Command analog input (A1). For example, if H3-02= 100%, H3-03= 0%, and the A2 analog input level is 1 Vdc, the Speed Command profile will look like the figure below. If A1= 0 Vdc the Speed Command would be 10% of the programmed maximum frequency because $A1 (0 \text{ Vdc}) + A2 (1 \text{ Vdc}) = 1 \text{ Vdc}$.

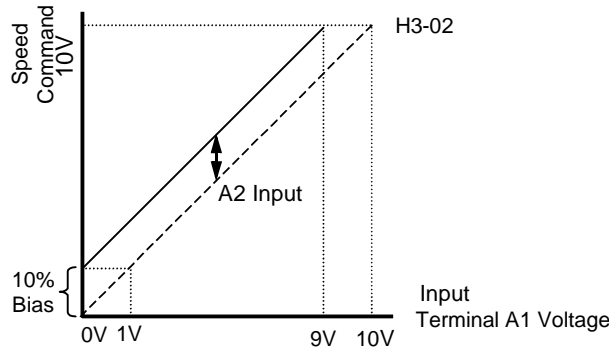

Fig. 53 Effect of Frequency Bias Function on Speed Command

It should be noted that the bias applied by the A2 analog input functions differently than the level set by the H3-03. If both biases are used simultaneously they will sum together.

The level of the A1 analog input, as a percentage of the maximum input (either 10 Vdc or 20 mA), can be viewed by the U1-15 monitor. The level of the A2 analog input, as a percentage of the maximum input, can be viewed by the U1-16 monitor.

The bias applied by setting H3-09= “0: Frequency Bias”, can be used in conjunction with the parameter bias H3-03. In that case the H3-03 bias is applied first which changes the slope of the Speed Command vs. Terminal A1 Voltage graph. Then the level of the A2 analog input is summed with the A1 analog input level, which in effect shifts the Speed Command vs. Terminal A1 Voltage graph upwards or downwards but does not change the slope of the line.

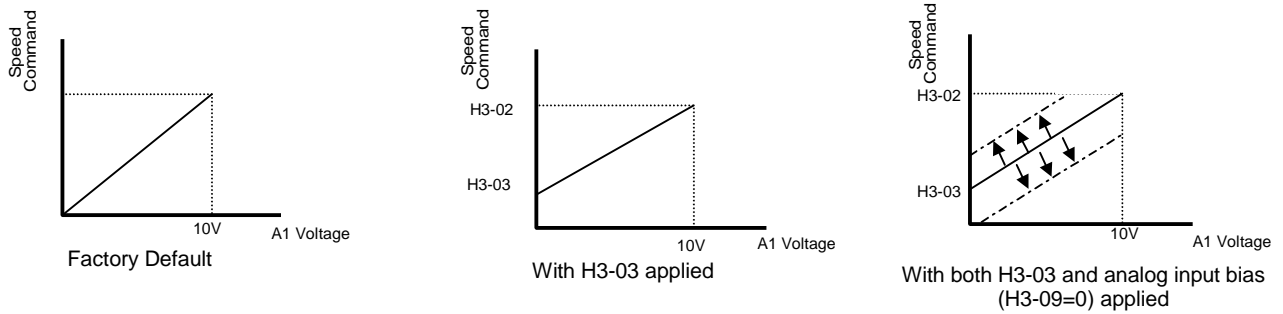

Fig. 54 Frequency Bias Applied to Analog Speed Command

Function: Aux Reference

Setting: 2

In order for the A2 analog input to be used as the master Speed Command, parameter H3-09 must be set for Aux Reference (H3-09= “2: Aux Reference”). Once A2 is configured as an auxiliary reference, it can be selected as the master Speed Command by setting H3-13= “1: Main Fref TA2”. If H3-09= 2, terminal A2 analog input will become the speed command when a digital input programmed for Multi-Step Ref 1 (H1-0x= 3) is selected by a contact closure.

Function: PI Feedback

Setting: B

Configuring the A2 analog input as PI Feedback (H3-09= “B: PI Feedback”) is a requirement of setting the Drive up for PI operation. The A2 analog input is the only source for feedback for PI operation though the setpoint can come from a number of different sources (refer to the section covering the PI parameters for more information regarding specifying the setpoint source. PI parameters are listed in section b5).

Parameters H3-10 (Terminal A2 Gain) and H3-11 (Terminal A2 Bias) can be used to configure the A2 analog input to match the signal from the Feedback Transmitter.

The U1-24 monitor (PI Feedback) can be used to check the PI Feedback level with the digital operator.

Function: Frequency Bias 2

Setting: D

By setting H3-09= “D: Frequency Bias 2”, the A2 analog input will serve as a bias signal to the A1 Speed Command. This setting functions the same as a setting of H3-09=0: Frequency Bias.

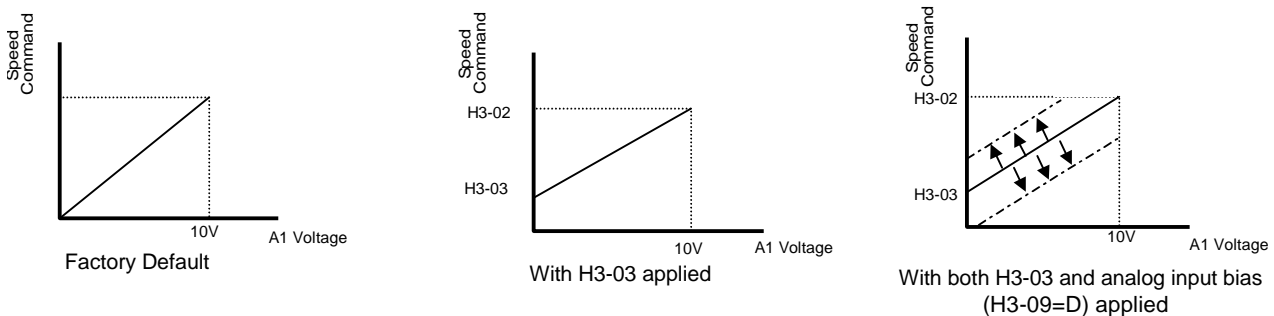

Fig. 55 Frequency Bias 2 Applied to Analog Speed Command

Function: Motor Temperature

Setting: E

In addition to or in place of the OL1 (Motor Overload) fault of the Drive, it is possible to use a PTC (Positive Temperature Coefficient) thermistor for motor insulation protection. The PTC thermistors are built into the windings of some motors and will vary their resistance based on temperature. An example PTC characteristic is show below.

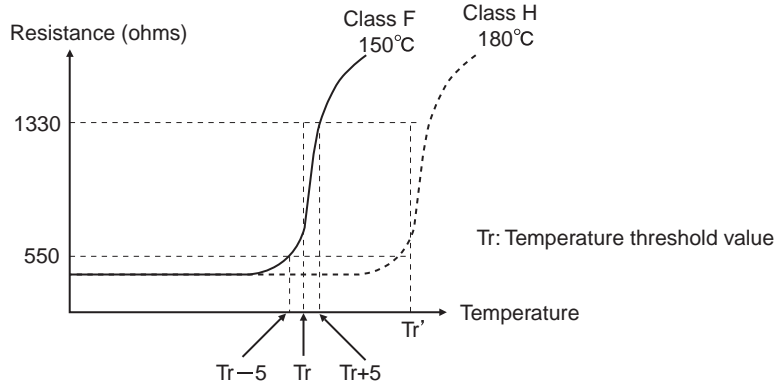
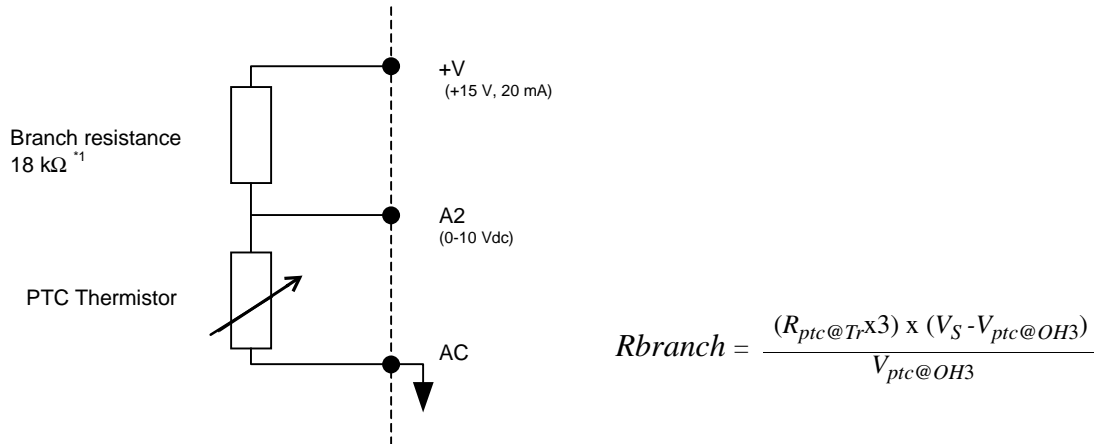

Fig. 56 PTC Thermistor Temperature-Resistance Value Characteristics

Connection of the thermistor to the Drive is shown below, in addition make sure Dip Switch S1-2 is in the OFF position, see Figure 52.



*1 The resistance value of 18 kΩ is only valid for using a 3-phase PTC with the characteristics shown in the figure above.

Fig. 57 Thermistor To Drive Connection Diagram

After the connections are made, configure the A2 analog input for motor temperature protection by setting H3-09= “E: Motor Temperature”. Parameters L1-03, L1-04, and L1-05 set the response to the alarm level being exceeded, response to the fault level being exceeded, and temperature sensing delay time, respectively.

The proper value of the branch resistance is approximated by the formula:

$$R_{branch} = \frac{(R_{ptc@Tr} \times 3) \times (V_S - V_{ptc@OH3})}{V_{ptc@OH3}}$$

Where: $(R_{ptc@Tr} \times 3)$ = The resistance value of the thermistor at either the alarm or fault level adjusted for three phase (three thermistors in series, refer to typical PTC thermistor characteristic in Figure 56).

V_S = The supply voltage (+15Vdc)

$V_{ptc@OH3}$ = The rated voltage for the over-temperature alarm or fault

Function: PI Differential

Setting: 16

Normal PI operation will adjust the Drive output in order to match the measured feedback value to a desired setpoint. When PI is operated in the differential mode, however, the Drive output is adjusted in order to maintain a desired differential between two feedback signals. Air handling unit return fan speed control in a “volume snatching” strategy for building pressure control is an example.

When the A2 analog input is configured as a PI Differential (H3-09= “16: PI Differential”), the A1 analog input becomes the other PI Differential input. The desired differential is set by parameter b5-07 (PI Differential Setpoint) and can be set so that A2 is held less than A1 (b5-07 <0) or A2 is held greater than A1 (b5-07 >0).

When PI Differential operation is chosen, the A1 feedback level can be monitored by U1-24 (PI Feedback) and the A2 feedback level can be monitored by U1-53 (PI Feedback2).

Function: Not Used

Setting: 1F

When H3-09= “1F: Not Used”, any signal applied to the A2 analog input will be ignored by the Drive.

■ **H3-10 Terminal A2 Gain Setting**

Setting Range: 0.0 to 1000.0%
 Factory Default: 100.0%

■ **H3-11 Terminal A2 Bias Setting**

Setting Range: -100.0% to +100.0%
 Factory Default: 0.0%

Parameters H3-10 and H3-11 perform the same function for the A2 analog input that parameters H3-02 and H3-03 perform for the A1 analog input. Please refer to the parameter description for H3-02 and H3-03 for information about H3-10 and H3-11.

These parameters could be used for final calibration of a factory or field installed pressure to electric transducer input connected to terminal A2 and AC. This field calibration may be needed if there is a job site variation from the typical 3 to 15 PSIG pneumatic signal input range.

■ **H3-12 Analog Input Filter Time Constant**

Setting Range: 0.0 to 2.00 Seconds
 Factory Default: 0.30 Seconds

An analog input filter can be used to prevent erratic Drive control when a “noisy” analog reference is used. Parameter H3-12 sets the time constant for a first order filter that will be applied to both the A1 and A2 analog inputs. The Drive operation becomes more stable the longer the time programmed, but it becomes less responsive to rapidly changing analog signals.

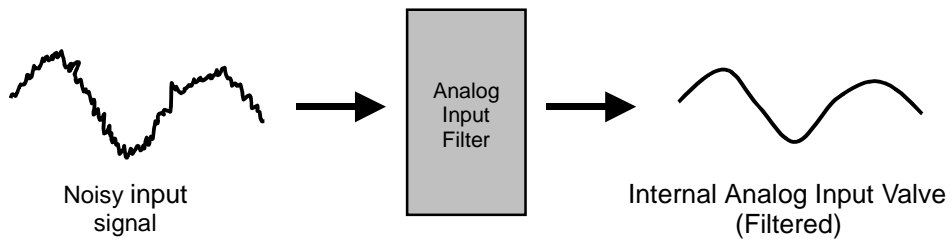

Fig. 58 Analog Input Filter Time Constant Effect on “Noisy” Signal

■ **H3-13 Master Frequency Reference Terminal Selection**

Setting	Description
0	Main Fref= A1(factory default)
1	Main Fref= A2

Parameter H3-13 allows the programmer to select which analog input will serve as the Speed Command input when “Terminals” are selected as the Auto Mode Speed source (b1-01= “1: Terminals”), or Terminal is selected as the reference source for the Hand mode (b1-12= “1: Terminals”). For the A2 analog input to be an effective selection for the H3-13 parameter, parameter H3-09 must be configured as Aux Reference (H3-09= “2: Aux Reference”).

If H3-09≠2, then the A1 analog input will be used regardless of the setting of parameter b1-12.

◆ H4 Analog Outputs

■ H4-01 Terminal FM Monitor Selection

Setting Range: 1 to 53

Factory Default: 2: Output Freq

The FM and AM analog output terminals can be programmed to output a 0-10 Vdc signal proportional to any one of functions detailed in the table below.

Setting	Description	Setting	Description
1	Frequency Ref	20	SFS Output*
2	Output Freq	24	PI Feedback
3	Output Current	31	Not Used
6	Output Voltage	36	PI Input
7	DC Bus Voltage	37	PI Output
8	Output kWatts	38	PI Setpoint
15	Term A1 Level	51	Auto Mode Fref
16	Term A2 Level	52	Hand Mode Fref
18	Mot SEC Current	53	PI Feedback 2

* SFS is the internal soft starter signal. This signal is generated from the reference and often it passes through the accel/ decel functions.

When the H4-01 or H4-04 are configured the Drive will output 10Vdc to represent 100% of the function programmed into them.

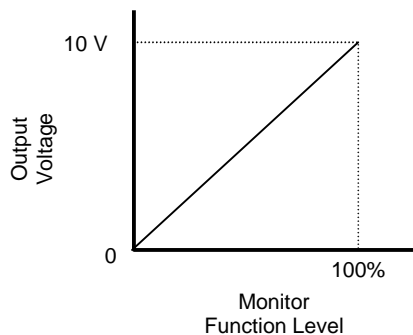

Fig. 59 Analog Output Signal Level as a Function of the Monitor Value

- **Function: Frequency Ref**
Setting: 1

The analog output level will correspond to the chosen Speed Command input whether it is input via the digital operator, analog input, or serial communication. 100% will be equivalent to the maximum output frequency of the Drive (E1-04).

- **Function: Output Freq**
Setting: 2

The analog output level will correspond to the actual Speed being output by the Drive and will include the acceleration and deceleration ramps. 100% will be equivalent to the maximum output frequency of the Drive (E1-04).

- **Function: Output Current**
Setting: 3

The analog output level will correspond to the output current level of the Drive. 100% will be equivalent to the Drives rated output current which is based on the kVA Rating of the Drive (o2-04).

- **Function: Output Voltage**
Setting: 6

The analog output level will correspond to the output voltage level of the Drive. 100% will be equivalent to either 200Vac or 400Vac depending on the input voltage rating of the Drive.

- **Function: DC Bus Voltage**
Setting: 7

The analog output level will correspond to the voltage level of the Drive's DC Bus. 100% will correspond to 400Vdc for the 240Vac input Drive and 800Vdc for the 480Vac input Drive.

- **Function: Output kWatts**
Setting: 8

The analog output level will correspond to an internally calculated output power level based on the measured output current and output voltage. 100% will correspond to the kilowatt rating of the Drive as determined by o2-04.

- **Function: Term A1 Level**
Setting: 15

The analog output level will correspond to the analog input to the Drive's A1 terminal. 100% will be equivalent to 10Vdc.

- **Function: Term A2 Level**
Setting: 16

The analog output level will correspond to the analog input to the Drive's A2 terminal. 100% will be equivalent to 10Vdc.

- **Function: Mot SEC Current**
Setting: 18

The analog output level will correspond to the calculated secondary (torque producing) current. 100% will be equivalent to motor's full load secondary current as calculated by:

$$\begin{aligned}
 I_{\text{sec}} &= \sqrt{I_{\text{Nameplate}}^2 - I_{\text{no load}}^2} \\
 &= \sqrt{(E2-01)^2 - (E2-03)^2}
 \end{aligned}$$

- **Function: SFS (Softstart) Output**
Setting: 20

The analog output level will correspond to the Speed Command after the applicable acceleration and deceleration rates are applied. The SFS (Softstart) Output monitor will not include variations to the Speed Command other than the acceleration and deceleration ramps. 100% will be equivalent to the maximum output frequency of the Drive (E1-04).

- **Function: PI Feedback**
Setting: 24

The analog output level will correspond to the analog input to the Drive's A2 terminal during normal PI operation but will correspond to the A1 analog input when the A2 analog input is configured as a PI Differential input (H3-09= "16: PI Differential"). The output will function even if PI operation is not selected (b5-01= "0: Disabled"). Parameter b5-20 will apply a gain to the measured analog output voltage before the monitor is displayed.
(i.e. with b5-20 = 5 the 2 Vdc feedback signal will generate 10 Vdc on the analog output).

- **Function: Not Used**
Setting: 31

When H4-01= "31: Not Used" no voltage is output by the analog output.

- **Function: PI Input**
Setting: 36

The analog output will correspond to the measured error of the PI function. The measured error of normal PI operation is the setpoint minus the feedback. The measured error of the differential PI is the difference between the A1 and A2 analog inputs summed with the PI differential setpoint). The output will not function unless PI operation is selected (b5-01≠0).

- **Function: PI Output**
Setting: 37

The analog output will correspond to the output of the PI function. The PI output will be measured after any gains, offsets, or limits are applied to the output of the Proportional and Integral factors. The output will not function unless PI operation is selected (b5-01≠0) and there is an active Run command. 100% will be equivalent to maximum frequency (E1-04).

- **Function: PI Setpoint**
Setting: 38

The analog output will correspond to the level of the chosen setpoint of the PI function. Please refer to table 1 included in the section PI Control (b5 parameters) for more information about selecting the PI setpoint source. The output will not function unless PI operation is selected (b5-01≠0).

- **Function: Auto Mode Fref**
Setting: 51

The analog output level will correspond to the Speed Command input chosen by the b1-01 parameter regardless of whether the Drive is being operated in the Auto mode or not. 100% will be equivalent to the maximum frequency of the Drive (E1-04).

- **Function: Hand Mode Fref**
Setting: 52

The analog output level will correspond to the Speed Command input chosen by the b1-12 parameter regardless of whether the Drive is being operated in the Hand mode or not. 100% will be equivalent to the maximum frequency of the Drive (E1-04).

- **Function: PI Feedback 2**
Setting: 53

The analog output level will correspond to the analog input to the Drive's A1 terminal during PI Differential operation but the analog output will not function during normal PI operation.

■ H4-02 Terminal FM Gain Setting

Setting Range: 0.0 to 1000.0%
Factory Default: 100.0%

Refer to parameter H4-03 for description details.

■ H4-03 Terminal FM Bias Setting

Setting Range: -110.0% to +110.0%
Factory Default: 0.0%

The gain and bias parameters for the analog outputs of the Drive allow the programmer to customize the output signal for the equipment connected to the output. The analog outputs are adjustable over a range of 0-10 Vdc. The gain settings for the analog outputs determine the output voltage level that will be equivalent to 100% of the Monitor Function Level. A gain setting greater than 100% will produce 10Vdc on the analog output when the monitor function is less than 100%.

For example, if H4-02= 150%, then the FM analog output will produce 6.7Vdc when the assigned output function initially reached the 100% level.

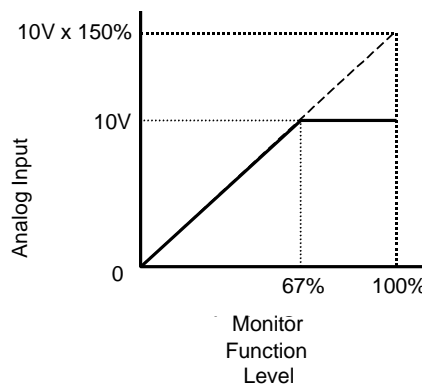

Fig. 60 Analog Output gain Setting Adjustment

Like the bias settings for the analog inputs (H3-03 and H3-11), the bias settings for the analog outputs determine the output function level that will be equivalent to 0Vdc (or 4mA if the optional terminal board is used).

For example, if H4-03= -25%, then when the output function level is at 0% the FM analog output will output 2Vdc.

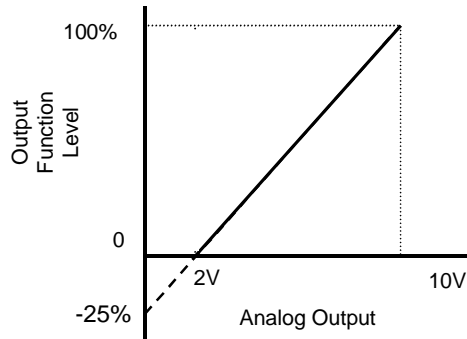

Fig. 61

■ **H4-04 Terminal AM Monitor Selection**

Setting Range: 1 to 53
 Factory Default: 8: Output kWatts

Refer to parameter H4-01 for description details.

■ **H4-05 Terminal AM Gain Setting**

Setting Range: 0.0 to 1000.0%
 Factory Default: 50.0%

■ **H4-06 Terminal AM Bias Setting**

Setting Range: -110.0% to +110.0%
 Factory Default: 0.0%

Refer to parameters H4-02 & H4-03 for description details.

■ **H4-07 Terminal FM Signal Level Selection**

H4-08 Terminal AM Signal Level Selection

Setting	Description
0	0 - 10 VDC (<i>factory default</i>)
1	4 - 20 mA

When the Drive is equipped with the optional, removable terminal board with 4-20mA outputs (p/n ETC618120), parameters H4-07 and H4-08 determine whether analog outputs are configured as 0-10Vdc or 4-20mA. Refer to the documentation for the optional terminal board as the proper jumper settings are required in addition to programming H4-07 and H4-08.

If the standard removable terminal board is being used, the settings of H4-07 and H4-08 have no effect.

◆ H5 Serial Communications Setup

This section explains the individual functions used in special applications involving Modbus Communications.

◆ Using Modbus Communication

Serial communication can be performed with Programmable Logic Controllers (PLC's) or similar devices using the Modbus protocol.

◆ Modbus Communication Configuration

Modbus communication is configured using 1 master (PLC) and a maximum of 31 slaves. Serial communication between master and slave is normally initiated by the master and responded to by the slaves.

The master performs serial communication with one slave at a time. Consequently, the slave address of each slave must be individually set, so that the master can perform serial communication using that address. Slaves receiving commands from the master perform the specified functions, and send a response back to the master.

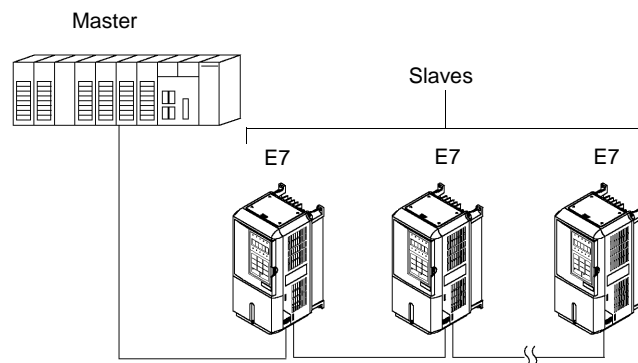

Fig. 62 Example of Connections between Master and Drive

◆ Communication Specifications

The Modbus communication specifications are shown below:

Item	Specifications
Interface	RS-422, RS-485
Communications Cycle	Asynchronous (Start-stop synchronization)
Communications Parameters	Baud rate: Select from 1200, 2400, 4800, 9600, and 19200 bps. Data length: 8 bits fixed Parity: Select from even, odd, or none. Stop bits: 1 bit selected
Communications Protocol	Modbus
Number of Connectable Units	31 units max.

◆ Communication Connection Terminal

Modbus communication uses the following terminals: S+, S-, R+, and R-. The terminating resistance must be turned ON only if the Drive is at the very end of the Serial Communication chain. Set the terminating resistance by turning ON pin 1 of switch S1 On the Drives terminal board. Switch S1 is located directly above the left most relay module.

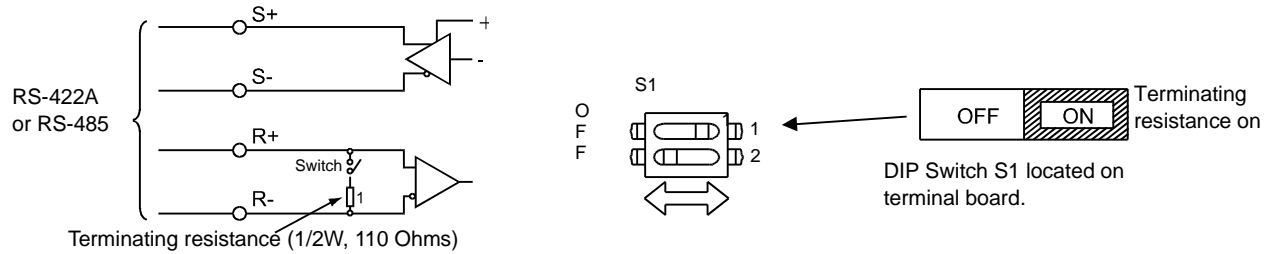
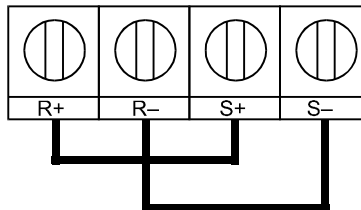

Fig. 63 Communication Connection Terminals and Terminating Resistance

IMPORTANT

1. Separate the communication cables from the main circuit cables and control circuit wiring.
2. Use shielded cables for the communication cable, and use proper shield clamps.
3. When using RS-485 2 Wire communication, connect S+ to R+, and S- to R-, on the control circuit terminal board. See diagram below.
4. Terminate shield at one end only.



◆ Procedure for Setting Up Communication

Use the following procedure to perform communication with the PLC.

1. Turn OFF the input power to the Drive and connect the communication cable between the PLC and the Drive.
2. Turn ON the input power to the Drive.
3. Set the required communication parameters (H5-01 to H5-09) using the Digital Operator.
4. Turn OFF the input power to the Drive, and check that the Digital Operator display has completely faded.
5. Turn ON the input power to the Drive once again.
6. Perform communication with the PLC.

■ Related Parameters

The following parameters need to be set correctly to insure proper operation of the Drive when using Modbus communication.

Parameter No.	Parameter Name Digital Operator Display	Description	Setting Range	Factory Setting	Menu Location
b1-01	Frequency Reference Selection Reference Source	Selects the speed command (frequency reference) input source. 0: Operator - Digital preset speed d1-01 1: Terminals - Analog Input Terminal A1 (or Terminal A2 see parameter H3-13) 2: Serial Com - RS-485 terminals R+, R-, S+ and S- 3: Option PCB - Option board connected at 2CN	0 to 3	1	Quick Setting
b1-02	Run Command Selection Run Source	Selects the Run command input source. 0: Operator - "Hand" and "Off" keys on digital operator 1: Terminal - Contact Closure on Terminal S1 2: Serial Com - RS-485 terminals R+, R-, S+ and S- 3: Option PCB - Option board connected at 2CN	0 to 3	1	Quick Setting
H5-01	Drive Node Address Serial Comm Adr	Selects drive station node number (address) for terminals R+, R-, S+, S-.*	0 to FF	1F	Programming
H5-02	Communication Speed Selection Serial Baud Rate	Selects the baud rate for terminals R+, R-, S+ and S-*. 0: 1200 Baud 1: 2400 Baud 2: 4800 Baud 3: 9600 Baud 4: 19200 Baud	0 to 4	3	Programming
H5-03	Communication Parity Selection Serial Com Sel	Selects the communication parity for terminals R+, R-, S+ and S-*. 0: No Parity 1: Even Parity 2: Odd Parity	0 to 2	0	Programming
H5-04	Stopping Method after Communication Error Serial Fault Sel	Selects the stopping method when a communication error is detected. 0: Ramp to Stop 1: Coast to Stop 2: Fast-Stop 3: Alarm Only 4: Run at D1-04 - available when H5-08 = "1: N2 METASYS" or "2: FLN APOGEE"	0 to 3	3	Programming
H5-05	Communication Error Detection Selection Serial Flt Dctct	Enables or disables the communications timeout detection function. 0: Disabled - A communications loss will NOT cause a communications fault. 1: Enabled - If communications is lost for more than the time specified in parameter H5-09, a communications fault will occur.	0 or 1	1	Programming
H5-06	Drive Transmit Wait Time Transmit WaitTIM	Sets the time from when the drive receives data to when the drive sends data.	5 to 65	5ms	Programming
H5-07	RTS Control Selection RTS Control Sel	Enables or disables request to send (RTS) control: 0: Disabled 1: Enabled	0 or 1	1	Programming
H5-08	Communication Protocol Selection Protocol Select	Selects the communication protocol. 0: Modbus 1: N2 (Metasys) 2: FLN (APOGEE)	0 to 2	0	Programming
H5-09	Communication Error Detection Time CE Detect Time	Determines how long communications must be lost before a fault is annunciated. Works in conjunction with parameters H5-05 and H5-04. * After these parameters are changed drive power must be cycled before the changes will take effect.	0.0 to 10.0	2.0sec	Programming

* Set H5-01 to 0 to disable Drive responses to Modbus communications.

Modbus communication can perform the following operations regardless of the settings in b1-01 and b1-02:

1. Monitoring operation status of the Drive
2. Setting and reading Drive parameters
3. Resetting faults
4. Input multi-function commands

IMPORTANT

An OR operation is performed between the multi-function command input from the PLC and the command input from multi-function digital input terminals S3 to S7.

■ Message Format

In Modbus communication, the master sends commands to the slave, and the slave responds. The message format is configured for both sending and receiving as shown below. The length of the data packets is changed by the command (function) contents.

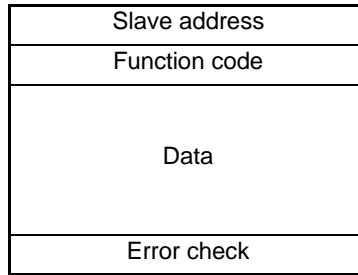

Fig.64 Message Format

The space between messages must support the following:

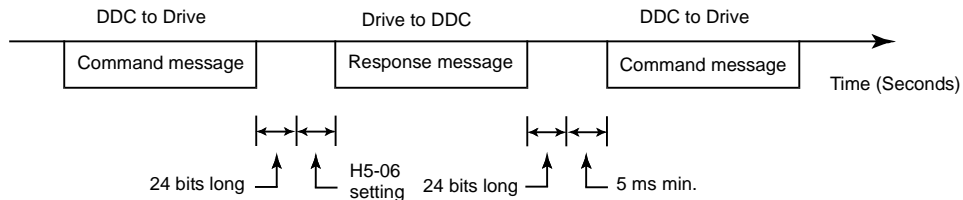

Fig.65 Message Spacing

Slave Address

Set the Drive address from 0 to 32. If 0 is selected, commands from the master will be broadcast (i.e., the Drive will not return responses).

Function Code

The function code specifies commands. There are four function codes supported by the Drive, as shown below.

Table 22 Modbus Function Codes					
Function Code (Hexadecimal)	Function	Command Message		Response Message	
		Min. (Bytes)	Max. (Bytes)	Min.* (Bytes)	Max. (Bytes)
03H	Reading/Holding Register Contents	8	8	7	37
06H	Write In Single Holding Register	8	8	8	8
08H	Loopback Test	8	8	8	8
10H	Write In Several Holding Registers	11	41	8	8

* Minimum bytes for a normal Response Message (error response message is always 5 bytes).

Data

Configure consecutive data by combining the storage register address (test code for a loopback address) and the data the register contains. The data length changes depending on the command details.

Error Check

Errors are detected during communication using CRC-16. Perform calculations using the following method:

1. The factory setting for CRC-16 communication is typically zero, but when using the Modbus system, set the factory setting to one (e.g., set all 16 bits to 1).
2. Calculate CRC-16 using MSB as slave address LSB, and LSB as the MSB of the final data.
3. Calculate CRC-16 for response messages from the slaves and compare them to the CRC-16 in the response messages.

Modbus Function Code Details

◆ Reading/Holding Register Contents (03H)

Read the contents of the storage registers only for the specified number of registers. The addresses must be consecutive, starting from a specified start register. The data content of the storage register are separated into high bytes and low bytes.

The following table shows message examples when reading status signals, error details, data link status, and frequency references from the slave 2 Drive.

Command Message			Response Message (During Normal Operation)			Response Message (During Error)		
Slave Address		02H	Slave Address		02H	Slave Address		02H
Function Code		03H	Function Code		03H	Function Code		83H
Start Register	High Byte	00H	Data quantity		08H	Error code		03H
	Low Byte	20H	First Storage Register	High Byte	00H	CRC-16	High Byte	F1H
No. of Registers	High Byte	00H		Low Byte	65H		Low Byte	31H
	Low Byte	04H	Second Storage Register	High Byte	00H			
High Byte		45H		Low Byte	00H			
CRC-16	Low Byte	F0H	Third Storage Register	High Byte	00H			
				Low Byte	00H			
			Fourth Storage Register	High Byte	01H			
				Low Byte	F4H			
			CRC-16	High Byte	AFH			
				Low Byte	82H			

Fig. 66 Function Code 03H Message Example

◆ Write In Single Holding Register (06H)

Command Message			Response Message (During Normal Operation)			Response Message (During Error)		
Slave address		01H	Slave address		01H	Slave address		01H
Function code		06H	Function code		06H	Function Code		86H
Register Address	Upper	00H	Register Address	Upper	00H	Error code		21H
	Lower	01H		Setting Data	Lower	01H	CRC-16	Upper
Setting Data	Upper	00H	Setting Data		Upper	00H		CRC-16
	Lower	01H		CRC-16	Lower	01H		
CRC-16	Upper	98H	CRC-16		Upper	98H		
	Lower	0BH		CRC-16	Lower	0BH		

Fig. 67 Function Code 06H Message Example

◆ Loopback Test (08H)

The loopback test returns the command message directly as the response message without changing the contents to check the communications between the master and slave. Set user-defined test code and data values.

The following table shows a message example when performing a loopback test with the slave 1 Drive.

Command Message			Response Message (During Normal Operation)			Response Message (During Error)		
Slave address		01H	Slave address		01H	Slave address		01H
Function code		08H	Function code		08H	Function code		88H
Test Code	High Byte	00H	Test Code	High Byte	00H	Error Code		01H
	Low Byte	00H		Data	Low Byte	00H	CRC-16	High Byte
Data	High Byte	A5H	Data		High Byte	A5H		CRC-16
	Low Byte	37H		CRC-16	Low Byte	37H		
CRC-16	High Byte	DAH	CRC-16		High Byte	DAH		
	Low Byte	8DH		CRC-16	Low Byte	8DH		

Fig. 68 Function Code 08H Message Example

◆ Write In Several Holding Registers (10H)

Write the specified data to the desired slave indicating the desired starting register. The written data must be consecutive, starting from the specified address in the command message: High Byte (8 bits), then Low Byte 8 bits, in sequential storage register order.

The following table shows an example of a message when a forward Run command has been set at a speed command of 60.0 Hz in the slave 1 Drive by the PLC.

Command Message			Response Message (During Normal Operation)			Response Message (During Error)		
Slave Address		01H	Slave Address		01H	Slave Address		01H
Function Code		10H	Function Code		10H	Function Code		90H
Start Register	High Byte	00H	Start Register	High Byte	00H	Error code		02H
	Low Byte	01H		Low Byte	01H	CRC-16	High Byte	CDH
No. of Registers	High Byte	00H	No. of Registers		High Byte		00H	Low Byte
	Low Byte	02H		Low Byte	02H			
No. of Bytes*		04H	CRC-16		High Byte	10H		
First 2 Bytes of data	High Byte	00H		Low Byte	08H			
	Low Byte	01H						
Second 2 Bytes of data	High Byte	02H						
	Low Byte	58H						
CRC-16	High Byte	63H						
	Low Byte	39H						

* No. of bytes = 2 x (# of Registers)

Fig. 69 Function Code 10H Message Example

IMPORTANT

Set the number of bytes as quantity of specified registers x 2. Handle response messages in the same way.

Modbus Data Tables

The data tables are shown below. The types of data are as follows: Reference data, monitor data and broadcast data.

◆ Reference Data

The reference data table is shown below. Reference data can be read and written to.

Table 23 Reference Data		
Register No.	Contents	
0000H	Reserved	
0001H	Sequence Control	
	Bit 0	Run Forward 1: Run 0: Stop
	Bit 1	Run Reverse 1: Run 0: Stop
	Bit 2	External fault 1: Fault (EFO)
	Bit 3	Fault reset 1: Reset command
	Bit 4	ComNet
	Bit 5	ComCtrl
	Bit 6	Multi-function digital input command 3
	Bit 7	Multi-function digital input command 4
	Bit 8	Multi-function digital input command 5
	Bit 9	Multi-function digital input command 6
	Bit A	Multi-function digital input command 7
	Bits B to F	Not used
0002H	Frequency reference (Set units using parameter o1-03)	
0003H to 0005H	Not used	
0006H	PI Setpoint	
0007H	Analog output 1 setting (-11 V = 726 to 11 V = 726) → 10V = 660	
0008H	Analog output 2 setting (-11 V = 726 to 11 V = 726) → 10V = 660	
0009H	Multi-function contact output setting	
	Bit 0	Digital output 1 (Terminal M1-M2) 1: ON 0: OFF
	Bit 1	Digital output 2 (Terminal M3-M4) 1: ON 0: OFF
	Bit 2	Not Used
	Bits 3 to 5	Not used
	Bit 6	Set fault contact (terminal MA-MC) output using bit 7. 1: ON 0: OFF
	Bit 7	Fault contact (terminal MA-MC) 1: ON 0: OFF
Bits 8 to F	Not used	
000AH to 000EH	Not used	
000FH	Reference selection settings	
	Bit 0	Not used
	Bit 1	Input PI setpoint 1: Enabled 0: Disabled
	Bits 3 to B	Not used
	C	Broadcast data terminal S5 input 1: Enabled 0: Disabled
	D	Broadcast data terminal S6 input 1: Enabled 0: Disabled
	E	Broadcast data terminal S7 input 1: Enabled 0: Disabled
F	Not used	
Note: Write 0 to all unused bits. Also, do not write data to reserved registers.		

Monitor Data

The following table shows the monitor data. Monitor data can only be read.

Table 24 Monitor Data		
Register No.	Contents	
0020H	Drive status	
	Bit 0	Running 1: Running 0: Stopped
	Bit 1	Reverse operation 1: Reverse operation 0: Forward operation
	Bit 2	Drive startup complete 1: Completed 0: Not completed
	Bit 3	Fault 1: Fault
	Bit 4	Data setting error 1: Error
	Bit 5	Multi-function digital output 1 (terminal M1 - M2) 1: ON 0: OFF
	Bit 6	Multi-function digital output 2 (terminal M3 - M4) 1: ON 0: OFF
	Bit 7	Not used
	Bits 8 to F	Not used
0021H	Fault details	
	Bit 0	Overcurrent (OC) Ground fault (GF)
	Bit 1	Main circuit overvoltage (OV)
	Bit 2	Drive overload (OL2)
	Bit 3	Drive overheat (OH1, OH2)
	Bit 4	Not used
	Bit 5	Fuse blown (PUF)
	Bit 6	PI feedback reference lost (FbL)
	Bit 7	External error (EF, EFO)
	Bit 8	Hardware error (CPF)
	Bit 9	Motor overload (OL1) or overtorque 1 (OL3) detected
	Bit A	PG broken wire detected (PGO), Overspeed (OS), Speed deviation (DEV)
	Bit B	Main circuit undervoltage (UV) detected
	Bit C	Main circuit undervoltage (UV1), control power supply error (UV2), inrush prevention circuit error (UV3), power loss
Bit D	Missing output phase (LF)	
Bit E	Modbus communications error (CE)	
Bit F	Operator disconnected (OPR)	
0022H	Data link status	
	Bit 0	Writing data
	Bit 1	Not used
	Bit 2	Not used
	Bit 3	Upper and lower limit errors
	Bit 4	Data integrity error
	Bits 5 to F	Not used
0023H	Frequency reference	U1-01
0024H	Output frequency	U1-02
0025H	Output voltage reference	U1-06
0026H	Output current	U1-03
0027H	Output power	U1-08
0028H	Torque reference	U1-09
0029H	Not used	
002AH	Not used	

Table 24 Monitor Data

Register No.	Contents	
002BH	Sequence input status	
	Bit 0	Input terminal S1 1: ON 0: OFF
	Bit 1	Input terminal S2 1: ON 0: OFF
	Bit 2	Multi-function digital input terminal S3 1: ON 0: OFF
	Bit 3	Multi-function digital input terminal S4 1: ON 0: OFF
	Bit 4	Multi-function digital input terminal S5 1: ON 0: OFF
	Bit 5	Multi-function digital input terminal S6 1: ON 0: OFF
	Bit 6	Multi-function digital input terminal S7 1: ON 0: OFF
	Bits 7 to F	Not used
002CH	Drive status	
	Bit 0	Operation 1: Operating
	Bit 1	Zero speed 1: Zero speed
	Bit 2	Frequency agree 1: Matched
	Bit 3	Desired frequency agree 1: Matched
	Bit 4	Frequency detection 1 1: Output frequency \leq L4-01
	Bit 5	Frequency detection 2 1: Output frequency \geq L4-01
	Bit 6	Drive startup completed 1: Startup completed
	Bit 7	Low voltage detection 1: Detected
	Bit 8	Baseblock 1: Drive output baseblock
	Bit 9	Frequency reference mode 1: Not communication 0: Communication
	Bit A	Run command mode 1: Not communication 0: Communication
	Bit B	Overtorque detection 1: Detected
	Bit C	Frequency reference lost 1: Lost
	Bit D	Retrying error 1: Retrying
Bit E	Error (including Modbus communications time-out) 1: Error occurred	
Bit F	Modbus communications time-out 1: Timed out	
002DH	Multi-function digital output status	
	Bit 0	Multi-function digital output 1 (terminal M1-M2) 1: ON 0: OFF
	Bit 1	Multi-function digital output 2 (terminal M3-M4) 1: ON 0: OFF
	Bit 2	Not used
	Bits 3 to F	Not used
002EH - 0030H	Not used	
0031H	Main circuit DC voltage	
0032H - 0037H	Not used	
0038H	PI feedback level (Input equivalent to 100%/Max. output frequency; 10/1%; without sign)	
0039H	PI input level ($\pm 100\%/\pm$ Max. output frequency; 10/1%; with sign)	
003AH	PI output level ($\pm 100\%/\pm$ Max. output frequency; 10/1%; with sign)	
003BH	CPU software number	
003CH	Flash software number	
003DH	Communication error details	
	Bit 0	CRC error
	Bit 1	Invalid data length
	Bit 2	Not used
	Bit 3	Parity error
	Bit 4	Overrun error
	Bit 5	Framing error
	Bit 6	Time-out
	Bits 7 to F	Not used
003EH	KVA setting	
003FH	Control method	
Note: Communication error details are stored until an error reset is input (errors can be reset while the Drive is operating).		

Broadcast Data

The following table shows the broadcast data. Broadcast Data Can Be Written (function Code 06H/10H) only.

Register Address	Contents	
0001H	Operation signal	
	Bit 0	Run forward 1: Run 0: Stop
	Bit 1	Reverse operation command 1: Run 0: Stop
	Bits 2 and 3	Not used
	Bit 4	External error (1: Fault set using H1-01)
	Bit 5	Error (Fault 1: Reset command set using H1-02)
	Bits 6 to B	Not used
	Bit C	Multi-function digital input terminal S5 input
	Bit D	Multi-function digital input terminal S6 input
	Bit E	Multi-function digital input terminal S7 input
0002H	Bit F	Not used.
0002H	Frequency reference	30000/100%

Note: Bit signals not defined in the broadcast operation signals use local node data signals continuously.

Enter Command

When writing parameters to the Drive from the PLC using Modbus communication, the parameters are temporarily stored in the constant data area in the Drive. To enable these parameters in the parameter data area, use the Enter command.

There are two types of Enter commands:

1. Enter commands that enable parameter data in RAM
2. Enter commands that write data to EEPROM (non-volatile memory) in the Drive at the same time as enabling data in RAM.

The following table shows the Enter command data. Enter command data can only be written.

The Enter command is enabled by writing 0 to register number 0900H or 0901H.

Register No.	Contents
0900H	Write parameter data to EEPROM
0910H	Parameter data is not written to EEPROM, but refreshed in RAM only.

IMPORTANT

The maximum number of times you can write to EEPROM using the Drive is 100,000. Do not frequently execute Enter commands (0900H) written to EEPROM.

The Enter command registers are write-only. Consequently, if reading these registers, the register address will become invalid (Error code: 02H).

Error Codes

The following table shows Modbus communication error codes.

Error Code	Contents
01H	Function code error A function code other than 03H, 08H, or 10H has been set by the PLC.
02H	Invalid register number error <ul style="list-style-type: none"> • The register address you are attempting to access is not recorded anywhere. • With broadcast sending, a start address other than 0000H, 0001H, or 0002H has been set.
03H	Invalid quantity error <ul style="list-style-type: none"> • The number of data packets being read or written is outside the range of 1 to 16. • In write mode, the number of data packets in the message is not No. of packets x 2.
21H	Data setting error <ul style="list-style-type: none"> • Upper limit or lower limit error has occurred in the control data or when writing parameters. • When writing parameters, the parameter setting is invalid.
22H	Write mode error <ul style="list-style-type: none"> • Attempting to write parameters to the Drive during run. • Attempting to write via Enter commands during run. • Attempting to write parameters other than A1-00 to A1-05, E1-03, or 02-04 when a CPF03 (defective EEPROM) fault has occurred. • Attempting to write read-only data.
23H	Writing during main circuit undervoltage (UV) fault <ul style="list-style-type: none"> • Writing parameters to the Drive during UV (main circuit undervoltage) alarm. • Writing via Enter commands during UV (main circuit undervoltage) alarm.
24H	Writing error during parameters processing Attempting to write parameters while processing parameters in the Drive.

Slave Not Responding

In the following cases, the slave will ignore the write function.

- When a communication error (overrun, framing, parity, or CRC-16) is detected in the command message.
- When the slave address in the command message and the slave address in the Drive do not agree.
- When the data that configures the message and the data time length exceed 24 bits.
- When the command message data length is invalid.

IMPORTANT

If the slave address specified in the command message is 0, all slaves execute the write function, but do not return response messages to the master.

Modbus Self-Diagnosis

The Drive has a built-in function for self-diagnosing the operations of serial communication interface circuits. The self-diagnosis function connects the communication parts of the send and receive terminals, receives the data sent by the Drive, and checks if communication is being performed normally.

Perform the self-diagnosis function using the following procedure.

1. Turn ON the power supply to the Drive, and set parameter H1-05 (Terminal S7 Function Selection) to 67 (Comm Test Mode).
2. Turn OFF the power supply to the Drive.
3. Perform wiring according to the following diagram while the power supply is turned OFF.
4. Turn ON the terminating resistance. (Turn ON pin 1 on DIP switch 1.)
5. Turn ON the power supply to the Drive again.

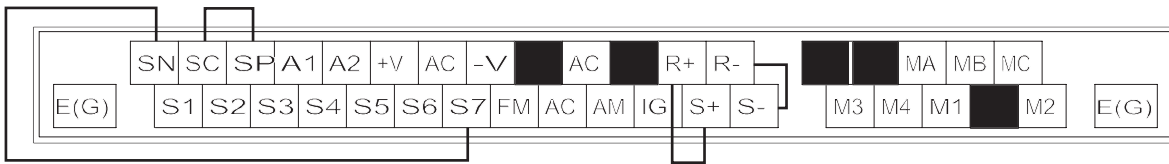

Fig. 70 Communication Terminal Connection for Self -Diagnosis Function

6. During normal self-diagnostic operation, the Digital Operator displays the frequency reference value. If an error occurs, a CE (Modbus communication error) alarm will be displayed on the Digital Operator, the fault contact output will be turned ON, and the Drive operation ready signal will be turned OFF.

■ H5-01 Drive Node Address

Setting Range: 0 to 20 (Hex) } MODBUS
 Factory Default: 1F }
 0 to FF } N2
 1F }
 0 to 63 } P1
 1F }

In order for a master to be able to communicate with the Drive using serial communications, the Drive must have a unique node address. The Drive is given a node address if H5-01≠0. The node addresses do not have to be assigned in sequential order but they must be unique, i.e. no two Drives on the same serial network can be assigned the same address. After setting the Drive address with the H5-01 parameter, the power to the Drive must be cycled for the addressing to take effect.

Leaving H5-01= 0 will disable responses to MEMOBUS communications.

■ H5-02 Communications Speed Selection

Setting	Description
0	1200 Baud
1	2400 Baud
2	4800 Baud (Standard for APOGEE)
3	9600 Baud (<i>factory default</i>) (Standard for Metasys)
4	19200 Baud

■ H5-03 Communications Parity Selection

Setting	Description
0	No Parity (<i>factory default</i>)
1	Even Parity
2	Odd Parity

Parameters H5-02 and H5-03 configure the Drives MEMOBUS communications via the RS-485/422 terminals on the removable terminal block. Configure H5-02 and H5-03 to match the settings of the master controller of the serial network. After changing the H5-02 or H5-03 parameter, the power to the Drive must be cycled for the change to take effect.

If either the speed or parity value is changed via the serial communications, the serial communications will cease to operate until the Drive power is cycled.

It may be necessary to avoid the 19.2 K baud setting if frequent serial communications errors occur at that baud rate.

■ H5-04 Stopping Method after Communication Error

Setting	Description
0	Ramp to Stop
1	Coast to Stop
2	Fast-Stop
3	Alarm Only (<i>factory default</i>)
4	Run at D1-04 (available when H5-08 = “1: N2 METASYS” or “2: FLN APOGEE”)

The setting of parameter H5-04 will determine the Drive’s reaction to a serial communications fault such as the CE fault. The Drive can be programmed to either ramp to a stop in the time specified by C1-02 (H5-04= “0: Ramp to stop”), coast to a stop (H5-04= 1), ramp to a stop at the special fast stopping time specified by C1-09 (H5-04= “2: Fast-Stop”), or continue operating using the commands received before the serial communication fault and flashing an alarm on the digital operator (H5-04= “3: Alarm Only”).

■ H5-05 Communications Error Detection Selection

Setting	Description
0	Disabled
1	Enabled (<i>factory default</i>)

The Drive can be configured by parameter H5-05 to recognize a CE fault whenever serial communications time-out. If H5-05= “1: Enabled”, the Drive will fault if serial communication responses are not received within a set period of time determined by parameter H5-09. Drive power should be cycled after a change is made to this parameter.

■ H5-06 Drive Transit Wait Time

Setting Range: 5 to 65 mS

Factory Default: 5 mS

Parameter H5-06 will set the delay time between the receiving of a message from the master and the sending of a response from the Drive back to the master. Drive power should be cycled after a change is made to this parameter.

■ H5-07 RTS Control Selection

Setting	Description
0	Disabled (RTS is always on)
1	Enabled (RTS turns on only when sending) (<i>factory default</i>)

RTS or Request To Send control is a method of flow control applied to messaging in serial communications. Parameter H5-07 configures whether the Drive will implement RTS messaging all the time (H5-07= “0: Disabled”) or only when sending (H5-07= “1: Enabled”). It is recommended to set H5-07= “0: Disabled”, when using RS-485 and set H5-07= “1: Enabled”, when using RS-422. Drive power should be cycled after a change is made to this parameter.

■ H5-08 Communication Protocol Selection

Setting	Description
0	Memobus (Modbus) (<i>factory default</i>)
1	N2 (Metasys)
2	FLN (APOGEE)

Since the Drive is capable of using MEMOBUS, Metasys N2, or Apogee FLN communications via the RS-485/422 terminals, parameter H5-08 must be programmed to specify to the Drive which format is being used. Drive power should be cycled after a change is made to this parameter.

■ H5-09 Communication Error Detection Time

Setting Range: 0.0 to 10.0 Seconds

Factory Default: 2.0 Seconds

The setting of parameter H5-09 determines the length of time that serial communications must be lost before a CE fault occurs. Setting H5-09= 0 will configure the Drive for the quickest CE fault detection but may cause nuisance faults. Drive power should be cycled after a change is made to this parameter.

◆ L1 Motor Overload

■ L1-01 Motor Overload Protection Selection

Setting	Description
0	Disabled
1	Std Fan Cooled (Enabled) (<i>factory default</i>)

The Drive has an I^2t electronic overload protection function, the OL1 fault, for protecting the motor from overheating. The Drive bases the protection on time, output current, and output frequency. The electronic thermal overload function is UL-recognized so an external thermal overload relay is not required.

If the Drive is connected to a single motor, the motor overload protection should be enabled (L1-01= “1: Std Fan Cooled”) unless another means of preventing motor thermal overload is provided.

The time before the OL1 fault will occur changes as the output frequency is reduced. The maximum output current level at which there is no time limit for operation (the OL Start Point) is different depending on the output frequency. For instance, if the Drive is being operated at 60 Hz and the output current level is below 106% of the motor’s rated current (E2-01), the Drive will run without an OL1 fault indefinitely. Once the 106% output current level is exceeded, de-rating of the OL1 time starts.

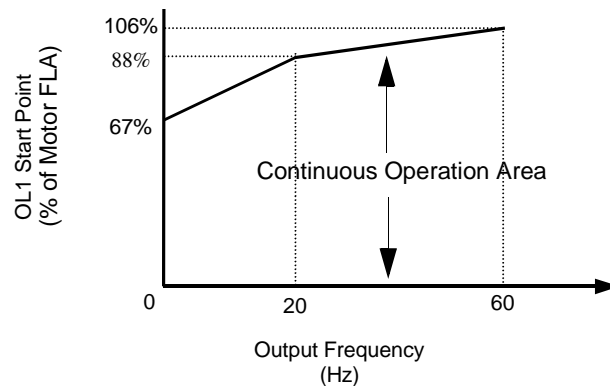

Fig. 71 Motor Overload Protection Curve

IMPORTANT

If the Drive is connected to more than one motor for simultaneous operation, the electronic overload protection should be disabled (L1-01= “0: Disabled”) and each motor should be wired with its own motor thermal overload.

■ L1-02 Motor Overload Protection Time

Setting Range: 0.1 to 20.0 Minutes

Factory Default: 8.0 Minutes

The L1-02 parameter will set the allowed operation time before the OL1 fault will occur when the Drive is running at 60 Hz and 133% of the motor's full load amp rating (E2-01). Adjusting the value of L1-02 can shift the set of OL1 curves up the Y-axis of the diagram below but will not change the shape of the curves.

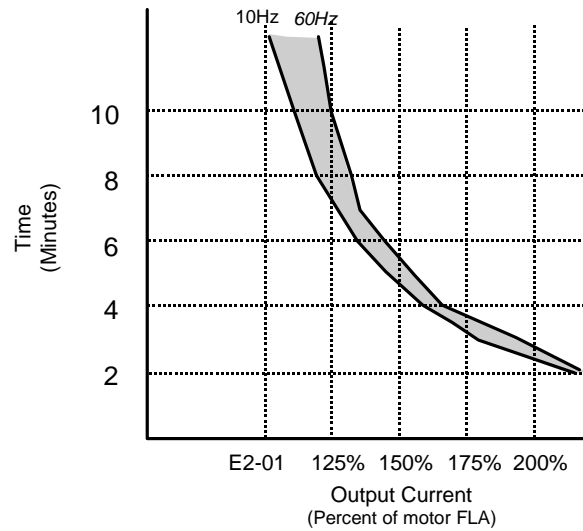

Fig. 72 Motor Overload Protection Time based on Output frequency and Load

■ L1-03 Motor Overheat Alarm Operation Selection

Setting	Description
0	Ramp to Stop
1	Coast to Stop
2	Fast-Stop
3	Alarm Only (<i>factory default</i>)

■ L1-04 Motor Overheat Fault Operation Selection

Setting	Description
0	Ramp to Stop
1	Coast to Stop (<i>factory default</i>)
2	Fast-Stop

■ L1-05 Motor Temperature Input Filter Time

Setting Range: 0.00 to 10.00 Seconds

Factory Default: 0.20 Seconds

The Drive can be programmed to accept a PTC (Positive Temperature Coefficient) Thermistor input for monitoring motor temperature. By setting parameter H3-09= “E: Motor Temperature”, and attaching the PTC thermistor per the figure below, the Drive can react to the increasing motor winding temperature with both an alarm (L1-03) and a fault (L1-04).

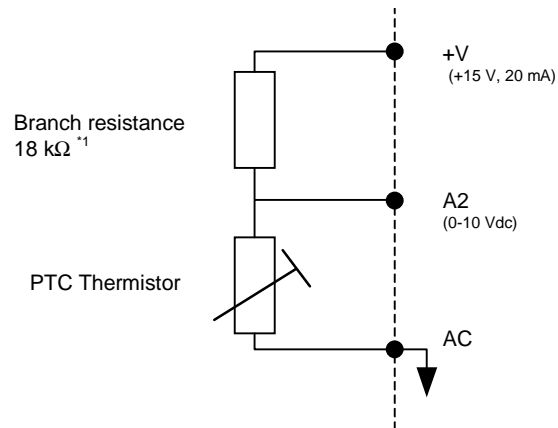

*1 The resistance value of 18 kΩ is only valid for using a 3-phase PTC with the characteristics shown in the figure on following page.

Fig. 73

A typical PTC Thermistor characteristic shown on the following page.

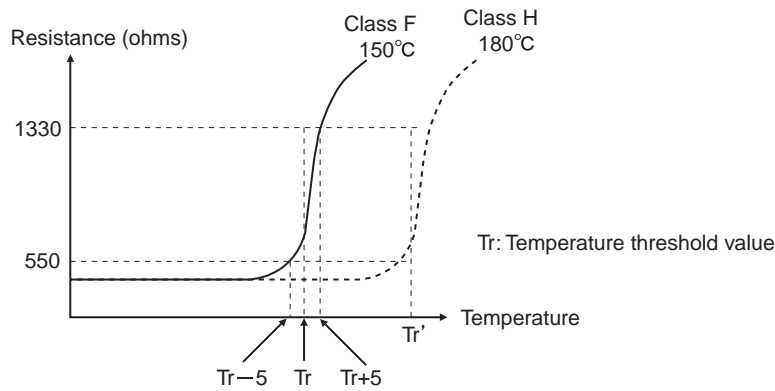

Fig. 74 PTC Thermistor Temperature-Resistance Value Characteristics

Using the changing voltage drop across the thermistor the voltage into the A2 analog input will vary according to the motor's winding temperature. If the measured voltage into A2 exceeds 1.17Vdc the Drive will flash an OH3 alarm on the digital operator and will either ramp to a stop in the time specified by C1-02 (L1-03= "0: Ramp to Stop"), coast to a stop (L1-03= "1: Coast to Stop"), ramp to a stop at the special fast stopping time specified by C1-09 (L1-03= "2: Fast-Stop"), or continue operating using the commands received before the OH3 alarm (L1-03= "3: Alarm Only"). The Drive's fault contact, MA-MB, will not close.

If the measured voltage into the A2 analog input exceeds 2.34Vdc the Drive will fault (OH4) and either ramp to a stop in the time specified by C1-02 (L1-04= "0: Ramp to Stop"), coast to a stop (L1-04= "1: Coast to Stop"), ramp to a stop at the special fast stopping time specified by C1-09 (L1-04= "2: Fast-Stop"). The Drive's fault contact, MA-MB, will close.

Parameter L1-05 will apply a time delay filter to the A2 analog input when it is configured as the thermistor input. The greater the time programmed into L1-05 the less responsive the Drive will be to quick changes to the input voltage but the more stable the input will be. A noisy input will benefit from a greater L1-05 time.

◆ L2 Momentary Power Loss Ride-thru Function

When momentary power loss recovery is enabled (L2-01≠0), a speed search is executed to catch the potentially spinning motor shaft. This speed search will occur regardless of the setting of b3-01 “Speed Search Selection”.

■ L2-01 Momentary Power Loss Detection Selection

Setting	Description
0	Disabled
1	PwrL Ride Thru t
2	CPU Power Active (<i>factory default</i>)

■ L2-02 Momentary Power Loss Ride-Thru Time

Setting Range: 0.0 to 25.5 Seconds

Factory Default: Model Dependent

The Drive allows different responses to momentary power losses. The setting of L2-01 determines whether the Drive attempts to restart after a short loss of incoming AC power and for what length of time this capability remains active.

If L2-01= “0: Disabled”, the Drive detects a UV1 fault 15ms after power loss and automatic restarting is disabled. The Drive cannot restart until the external run command is removed and the UV1 fault is reset.

If L2-01= “1: PwrL Ride Thru t”, the Drive restarts without the UV1 fault if power is returned within the time specified in L2-02, the Momentary Power Loss Ride-thru Time. During the power loss but before the fault trip, the digital operator will display a UV alarm. If L2-02 is set for a time longer than the control power supply can be sustained, a UV1 fault will not occur and the Drive restarts upon the return of AC power. The time that the control power supply can be maintained varies with Drive size. The larger the Drive, the greater the potential ride-thru time.

If L2-01= “2: CPU Power Active”, the Drive ignores L2-02 and attempts a restart as long as the control power supply is still able to maintain a minimal voltage level. In effect, setting L2-01= “2: CPU Power Active” (factory default) is programming the Drive for maximum Power Loss Ride-thru. An equivalent setting is L2-01= “1: PwrL Ride Thru t”, with L2-02 set to a time longer than the control power supply can be maintained after power is lost.

Note: The run command must be held during power loss for any power loss ride-thru capability to be possible. It is for this reason that 3-wire control is not recommended for use with the Momentary Power Loss function.

■ L2-03 Momentary Power Loss Minimum Baseblock Time

Setting Range: 0.1 to 5.0 Seconds

Factory Default: Model Dependent

When momentary power loss recovery is enabled (L2-01≠0) the Drive will baseblock for a period of time specified by the L2-03 parameter. The baseblock time will be executed just prior to the speed search function in order to allow any residual magnetic fields in the motor windings to decay before any new voltage is applied to the motor.

If the motor’s secondary circuit time constant is known, set L2-03= 0.7x (value of time constant). If an OC or OV fault occurs during momentary power loss recovery, increase the setting of L2-03.

The L2-03 parameter also sets the baseblock time for the DC Injection Braking function (b1-03= “2: DC Injection to Stop”). If an OC or OV fault occurs during DC Injection Braking to Stop, increase the setting of L2-03.

■ L2-04 Momentary Power Loss Voltage Recovery Ramp Time

Setting Range: 0.0 to 5.0 Seconds

Factory Default: Model Dependent

When momentary power loss recovery is enabled (L2-01≠0), a speed search is executed to catch the potentially spinning motor shaft. As part of the speed search function full voltage is not immediately applied to the motor but is ramped up. The setting of parameter L2-04 determines the ramp time for increasing the output voltage from zero to maximum voltage (E1-05).

If a UV1 fault occurs during the current detection speed search function, increase the setting of L2-04.

■ L2-05 Undervoltage Detection Level

Setting Range: 150 to 210 VDC

Factory Default: 190 VDC

The L2-05 parameter sets the DC Bus undervoltage level. The setting of L2-05 affects the voltage at which a UV alarm or a UV1 fault will occur. If the setting of L2-05 is lowered below the factory default level (190Vdc for a 240Vac drive and 380Vdc for a 480Vac drive), then an AC Input Reactor must be installed on the input AC line to prevent inrush current from damaging the Drive's input diodes. An AC Line dip and fast voltage recovery can potentially cause a large inrush current.

◆ L3 Stall Prevention

■ L3-01 Stall Prevention Selection During Accel

Setting	Description
0	Disabled
1	General Purpose (<i>factory default</i>)
2	Intelligent

■ L3-02 Stall Prevention Level During Accel

Setting Range: 0 to 200% of Drive rated output current

Factory Default: 120% of Drive rated output current

The stall prevention during acceleration function adjusts the acceleration time in order to prevent OC fault trips during acceleration. If L3-01= "0: Disabled", stall prevention is disabled. If the load is large enough and the acceleration time short enough the Drive may fault and stop.

If L3-01= "1: General Purpose", then the standard stall prevention function is enabled. When the output current exceeds the level set by the L3-02 parameter, the Drive will discontinue accelerating and maintain speed. If, during acceleration, the output current comes within 15% of the level set by parameter L3-02, the acceleration time is lengthened. Once the output current level has dropped below the L3-02 level, acceleration will begin again with the acceleration rate reaching the programmed rate once again 15% below the L3-02 level.

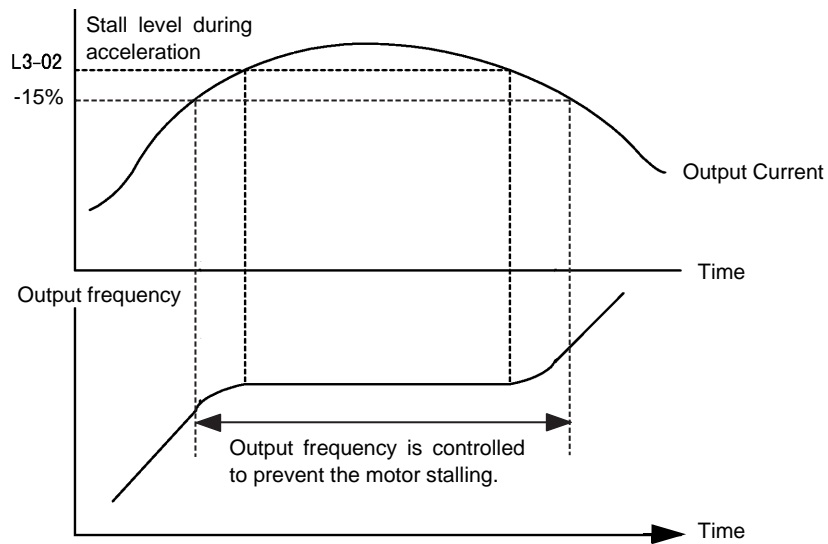

Fig. 75 Detailed Time Chart for Stall Prevention During Acceleration

If L3-01= “2: Intelligent”, the intelligent stall prevention is enabled. The active acceleration time is ignored and the Drive will attempt to accelerate as quickly as possible without exceeding the L3-02 output current level.

IMPORTANT | Stall Prevention during Acceleration is not effective when the output frequency is less than 6Hz.

The following figure demonstrates acceleration when L3-01= “1: General Purpose”.

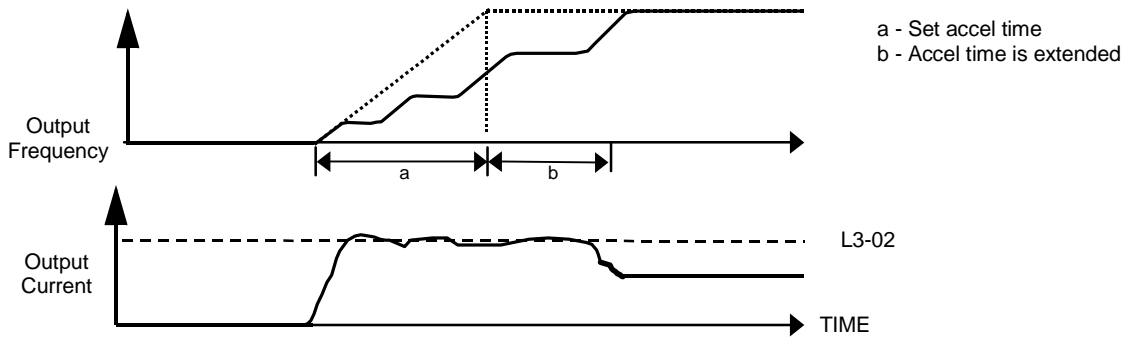

Fig. 76 Time Chart for Stall Prevention During Acceleration

The L3-02 parameter is set as a percentage of the Drive rated output current. If the motor capacity is small compared to the Drive’s capacity, or if the motor stalls during acceleration, lower the set value of L3-02.

■ L3-04 Stall Prevention Selection During Decel

Setting	Description
0	Disabled
1	General Purpose (<i>factory default</i>)
2	Intelligent
3	Stall prev w/R

The stall prevention during deceleration function adjusts the deceleration time in order to prevent OV fault trips during deceleration. If L3-04= “0: Disabled”, stall prevention is disabled and if the load is large and the deceleration time short enough the Drive may fault and stop.

If L3-04= “1: General Purpose”, then the standard stall prevention function is enabled. If, during deceleration, the DC Bus voltage exceeds the stall prevention level (see table below), the Drive will discontinue decelerating and maintain speed. Once the DC Bus voltage has dropped below the stall prevention level, the deceleration will continue down to the Speed Command level. See figure below.

Drive Voltage		Stall Prevention Level during Deceleration (V)
240Vac		380
480Vac	E1-01 ≥ 400Vac	760
	E1-01 < 400Vac	660

If L3-01= “2: Intelligent”, the intelligent stall prevention is enabled. The active deceleration time is ignored and the Drive will attempt to decelerate as quickly as possible without causing the DC Bus voltage to exceed the stall prevention level.

The following figure demonstrates acceleration when L3-04= “1 General Purpose”.

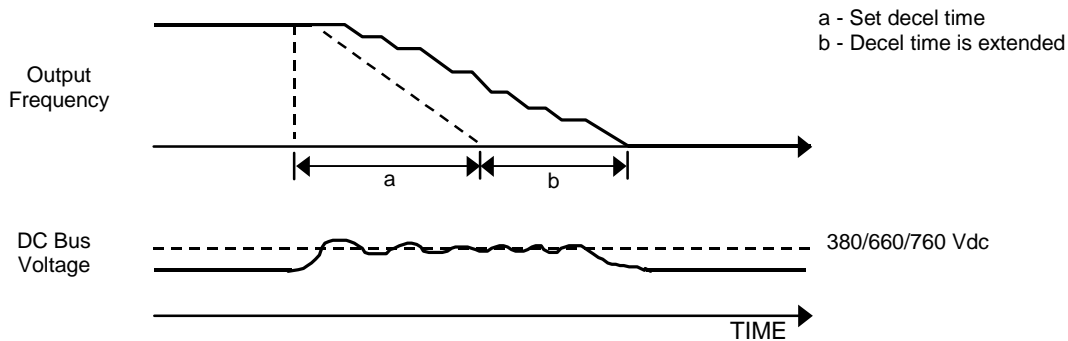

Fig. 77 Time Chart for Stall Prevention During Deceleration

■ L3-05 Stall Prevention Selection During Running

Setting	Description
0	Disabled
1	Decel Time 1 (<i>factory default</i>)
2	Decel Time 2

■ L3-06 Stall Prevention Level During Running

Setting Range: 30 to 200% of Drive rated output current

Factory Default: 120% of Drive rated output current

The Stall Prevention During Running function will attempt to avoid a Drive OC fault occurrence while the Drive is operating at a constant speed. If L3-05= "0: Disabled", the Drive may fault if the load increases sufficiently to cause the output current to reach the OC fault level (180% of Drive rated output current).

If L3-05= "1: General Purpose", the Drive is outputting a constant speed, and the Drive's output current level exceeds the level set by parameter L3-06 for more than 100 ms the Drive will begin to decelerate at the rate specified by parameter C1-02. The Drive will continue to decelerate until the output current level drops below the L3-06 level (less a 2% hysteresis). Once the output current drops below the L3-06 - 2% level the Drive will begin to accelerate at the currently active acceleration rate (either C1-01 or C1-03).

If L3-05= "2: Decel Time 2", the Drive will function as described above except C1-04 will be used instead of C1-02 as the deceleration rate used when the output current exceeds L3-06 for more than 100 ms.

The following figure demonstrates acceleration when L3-05≠0.

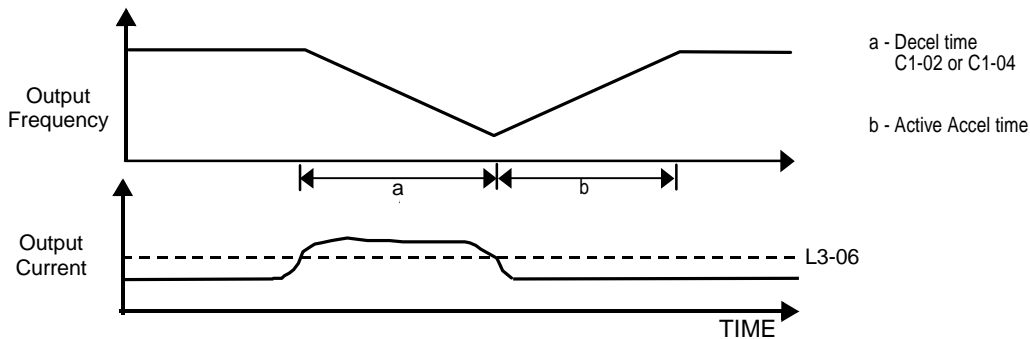

Fig. 78 Time Chart for Stall Prevention Level During Running

The L3-06 parameter is set as a percentage of the Drive rated output current. If the Drive still faults when L3-05≠0, then either lower the L3-06 or adjust the C1-02 or C1-04 settings for a quicker deceleration.

◆ L4 Speed Command Loss Detection

■ L4-01 Speed Agreement Detection Level

Setting Range: 0.0 to 200.0 Hz
 Factory Default: 0.0 Hz

■ L4-02 Speed Agreement Detection Width

Setting Range: 0.0 to 20.0 Hz
 Factory Default: 2.0 Hz

Parameters L4-01 and L4-02 are user specified levels for use with the Fref/Fout Agree 1, Fref/Set Agree 1, and Freq Detect 1 & 2 digital output functions. Please refer to the H2 Digital Output Parameters for more information.

■ L4-05 Frequency Reference Loss Detection Selection

Setting	Description
0	Disabled
1	Enabled @ % of PrevRef (<i>factory default</i>)

■ L4-06 Frequency Reference at Loss of Frequency Reference

Setting Range: 0.0 to 100.0% of previous speed command
 Factory Default: 80.0% of previous speed command

The Drive can be configured to compensate for the loss of its external speed command. An external speed command is considered lost if it drops 90% of its value in 400mS or less.

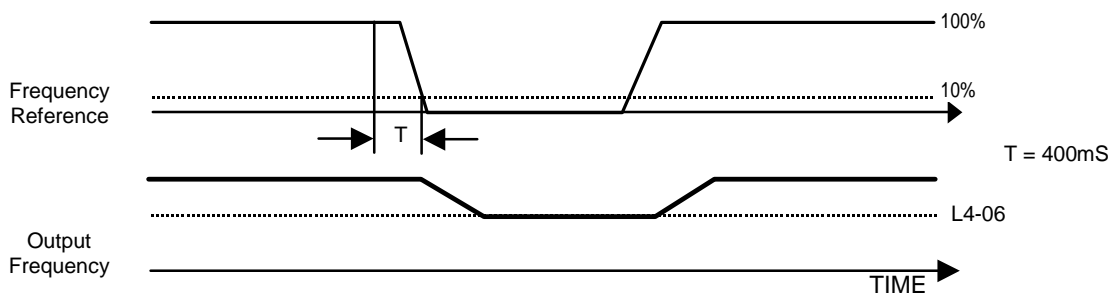

Fig. 79 Loss of Frequency Reference Timing Diagram

To enable Frequency loss detection, set L4-05= “1: Enabled @ % of PrevRef”. If Frequency Reference Loss Detection is enabled and the reference is lost, the Drive continues to operate at the speed commanded by parameter L4-06. When the speed command returns, the Drive again follows the speed command.

Setting H2-01/H2-02= “C: Loss of Ref”, configures a digital output as a Frequency Reference Loss indication only when L4-05= “1: Enabled @ % of PrevRef”.

◆ L5 Fault Restart

■ L5-01 Number of Auto Restart Attempts

Setting Range: 0 to 10
 Factory Default: 0

■ L5-02 Auto Restart Operation Selection

Setting	Description
0	No Flt Relay (<i>factory default</i>)
1	Flt Relay Active

■ L5-03 Maximum Restart Time After Fault

Setting Range: 0.5 to 600.0 Seconds
 Factory Default: 180.0 Seconds

All major faults will cause the Drive to stop. For some faults it is possible to configure the Drive to attempt a restart automatically. After the fault occurs, the Drive baseblocks for L2-03 seconds. After the baseblock is removed the Drive checks if a fault condition still exists. If no fault condition exists the Drive will attempt to restart the motor. If the restart is successful, the Drive performs a Speed Search (Regardless of the status of b3-01 “Speed Search Selection”) from the set speed command and the Auto Restart Attempts count is increased by one. Even if the restart fails the restart count is increased by one as long as the Drive attempted to rotate the motor. The restart count will not be incremented if the restart is not attempted due to a continuing fault condition, (i.e. an OV fault). The Drive waits L5-03 seconds before attempting another restart.

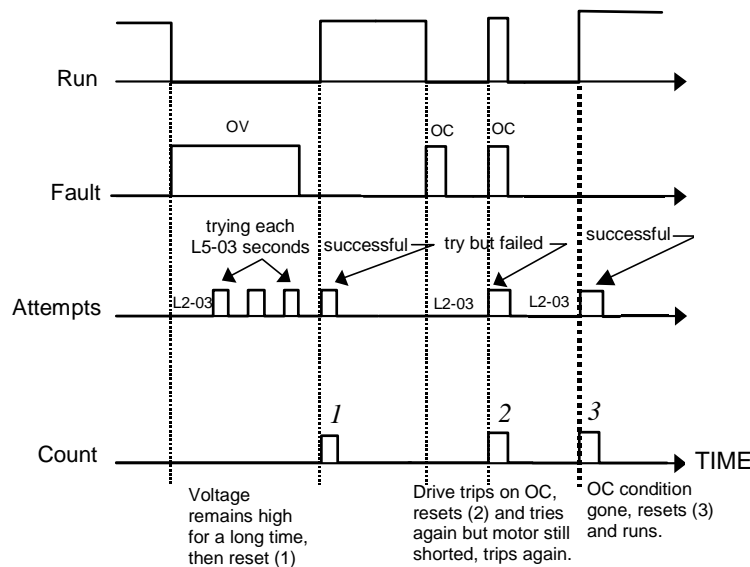

Fig. 80 Automatic Restart Timing Diagram

The auto restart count is reset back to 0 if any of the following occur:

- No further faults for ten minutes after the last retry.
- The Drives power is turned off (the Drive must be without power long enough to let control power dissipate).
- The SHIFT/RESET key is pushed after the last reset attempt.

The setting of parameter L5-02 determines whether the fault output (MA-MB) will be closed during an auto restart attempt. The setting of L5-02 can be important when interfacing the Drive with other equipment.

The following faults will allow the Auto Restart function to initiate:

- OC (Overcurrent)
- LF (Output Open Phase)
- PF (Input Phase Loss)
- PUF (DC Bus Fuse)
- OL1 (Motor Overload)
- OL3 (Overtorque)
- OL2 (Drive Overload)
- OV (DC Bus Overvoltage)
- GF (Ground Fault)
- UV1 (DC Bus Undervoltage)
- OH1 (Overheat)

In order for auto restart after a UV1 fault, Momentary Power Loss Ride-thru must be enabled (L2-01= "1: PwrL Ride Thru t", or "2: CPU Power Active"). Setting H2-01 or H2-02 equal to "1E" configures a digital output as "Restart Enabled" to signal if an impending auto restart is possible.

◆ L6 Torque Detection

■ L6-01 Torque Detection Selection 1

Setting	Description
0	Disabled (<i>factory default</i>)
1	OL@SpdAgree - Alm
2	OL At Run -Alm
3	OL@SpdAgree - Flt
4	OL At Run - Flt
5	UL@SpdAgree - Alm
6	UL at Run - Alm
7	UL@SpdAgree - Flt
8	UL At Run - Flt

■ L6-02 Torque Detection Level 1

Setting Range: 0 to 300% of Drive rated output current

Factory Default: 15% of Drive rated output current

■ L6-03 Torque Detection Time 1

Setting Range: 0.0 to 10.0 Seconds

Factory Default: 10.0 Seconds

The Drive can be programmed to indicate when either an overtorque or an undertorque conditions exist. A digital output must be programmed for “Torque Detection”, (H2-01/H2-02= “B: Trq Det 1 N.O.” or “17: Trq Det 1 N.C.”). A warning of an overtorque condition can indicate a jam and an undertorque condition can indicate a broken belt, no water in a pump, or other loss of load.

To configure Torque Detection requires the following decisions:

1. Do you wish to check for an overtorque condition or an undertorque condition?
2. Do you wish to check for the torque condition whenever the drive is running or only at speed agree? Nuisance detection during acceleration, when variable torques are normally required, can be avoided.
3. Do you want the drive to fault if the torque condition is detected or only alarm and continue operation?

The following table can help choose the proper setting for Torque Detection Selection 1 to get the wanted results.

L6-01 Setting	Overtorque	Undertorque	Fault	Alarm	Always Detected	Only Detected @ Spd Agree
0	Torque Detection Disabled					
1	X			X		X
2	X			X	X	
3	X		X			X
4	X		X		X	
5*		X		X		X
6		X		X	X	
7		X				X
8		X			X	

*Suggested settings for Loss of Load indication

After selecting the proper detection scheme the Torque Detection Level (L6-02) must be specified. If the current level read by the output current transformers rises above (overtorque) or drops below (undertorque) this level, and remains there for at least the Torque Detection Time (L6-03), then the Torque Detection Function will change the state of any digital output configured for Torque Detection (H2-01/H2-02= "B: Trq Det 1 N.O.", or "17: Trq Det 1 N.C.").

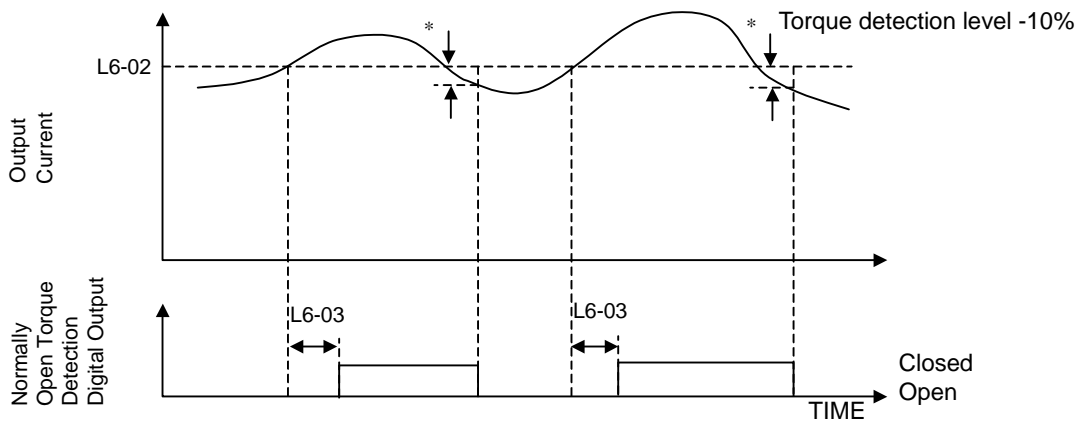

* When the output current drops below the Torque Detection Level by approximately 10% of the Drive's rated output current the digital output is reset.

Fig. 81 Over Torque Detection

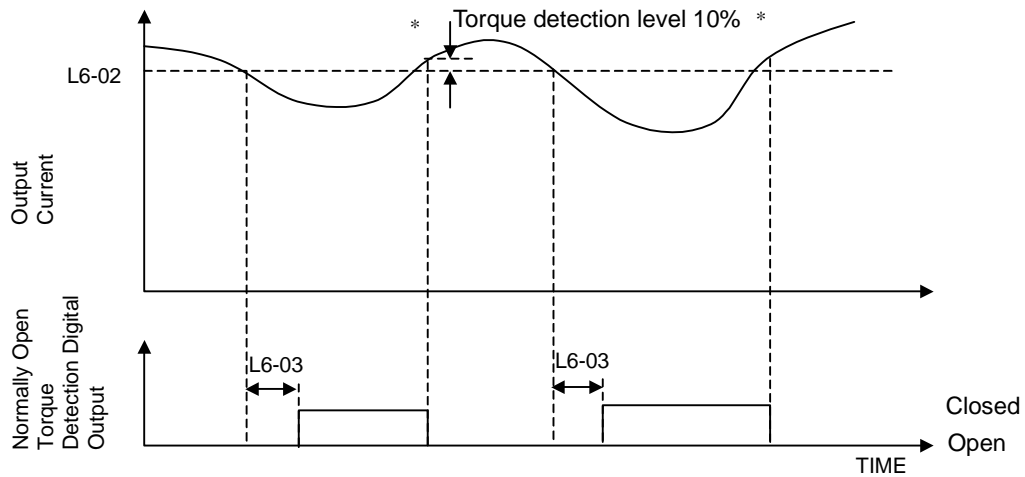

* When the output current rises above the Torque Detection Level by approximately 10% of the Drive's rated output current the digital output is reset.

Fig 82 Under Torque Detection

◆ L8 Hardware Protection

■ L8-01 Internal Dynamic Braking Resistor Protection Selection

Setting	Description
0	Not Provided (<i>factory default</i>)
1	Provided

This parameter is not applicable for Drive operation.

■ L8-02 Overheat Pre-Alarm Level

Setting Range: 50 to 130°C

Factory Default: 95°C

■ L8-03 Overheat Pre-Alarm Operation Selection

Setting	Description
0	Ramp to Stop (Decel Time C1-02)
1	Coast to Stop
2	Fast-Stop (Decel Time C1-09)
3	Alarm Only
4	OH Alarm and Reduce (<i>factory default</i>)

The Drive is capable of warning the operator of an impending heatsink over-temperature fault via an OH pre-alarm. The level at which the pre-alarm will activate is determined by the setting of parameter L8-02. Measurement of the heatsink temperature is done with several strategically mounted thermistors. If any of the heatsink thermistors measure a temperature in excess of the setting of L8-02, the Drive will fault (OH2) and either: ramp to stop using the C1-02 deceleration rate (L8-03= “0: Ramp to Stop”), coast to stop (L8-03= “1: Coast to Stop”), ramp to stop using the C1-09 fast stop deceleration rate (L8-03= “2: Fast-Stop”), alarm (OH) and continue running (L8-03 = “3: Alarm Only”), alarm (OH) and continue running but at a reduced speed (L8-03= “4: Alarm & Reduce”). If L8-03= 4: Alarm and Reduce, the Drive will continue to run but will reduce the speed to the level determined by parameter L8-19. Refer to the description for parameter L8-19.

If a digital output is configured for OH Prealarm (H2-01= “20: OH PreAlarm”), it will close whenever the heatsink temperature is greater than the L8-02 level no matter what the setting is of L8-03.

■ L8-06 Input Phase Loss Detection Level

Setting Range: 0.0 to 25.0% of Drives OV Trip point

Factory Default: KVA Dependent

The Drive checks for a lost input phase by monitoring the DC Bus voltage ripple. After an initial delay of approximately 12 seconds, the Drive will sample the DC BUS voltage every 1.28 seconds to determine the minimum and maximum voltage readings. The difference between the minimum and maximum voltage is averaged over ten consecutive scans. If this “averaged” value is greater than the trip level as determined by L8-06 (L8-06 x 400 for 200 volt class Drives; L8-06 x 800 for 400 volt class Drives) the Drive shuts down and displays “PF”, an input phase loss fault.

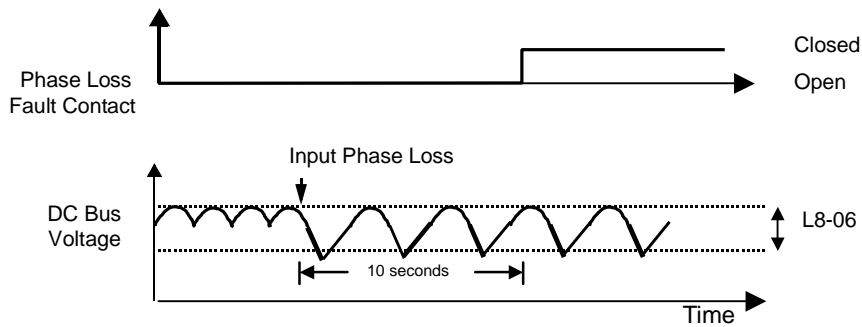

Fig. 83 Input Phase Loss Detection Diagram

■ L8-09 Output Ground Fault Detection Selection

Setting	Description
0	Disabled
1	Enabled (<i>factory default</i>)

The Drive has a ground fault detection circuit that activates when the current to ground exceeds 50% of the Drive's rated output current. The current to ground is determined by comparing the measured current on each of the output phases. If the current to ground is determined to be above 50% of the Drive's rated output current the digital operator will display a GF and the Drive will coast to stop.

■ L8-10 Heatsink Cooling Fan Operation Selection

Setting	Description
0	Fan On-Run Mode (<i>factory default</i>)
1	Fan Always On

■ L8-11 Heatsink Cooling Fan Operation Delay Time

Setting Range: 0 to 300 Seconds

Factory Default: 300 Seconds

Parameters L8-10 and L8-11 allow the Drive programmer to customize the heatsink cooling fan operation. Parameter L8-10 determines whether the cooling fans are always ON whenever the Drive is powered (L8-10= "1: Fan Always On") or if the cooling fans are only ON when the Drive is in a Run condition (L8-10= "0: Fan On-Run Mode").

Parameter L8-11 is a delayed OFF for the cooling fan if L8-10= "0: Fan On-Run Mode". When the cooling fans are set to turn OFF when the Run command is removed, parameter L8-11 will cause the fans to continue cooling the Drive for the amount of time programmed into L8-11 after the Run command is actually removed. The Drive can be programmed to allow the cooling fan to run for up to 5 minutes (factory default) after the run command is removed.

Both parameters are intended to extend fan life while still providing sufficient cooling for proper Drive operation.



Fig. 84 Heatsink Cooling Fan Operation Timing Diagram

■ L8-12 Ambient Temperature Setting

Setting Range: 113 to 140°F (45 to 60°C)

Factory Default: 113°F (45°C)

Set parameter L8-12 to the temperature °F (°C) of the area in which the Drive is mounted. If L8-12 exceeds the actual rated ambient temperature of the Drive 113°F (45°C), the OL2 fault level will be de-rated as shown in the figure below. This will allow the user to trade-off lighter drive loading for operation in a higher ambient temperature.

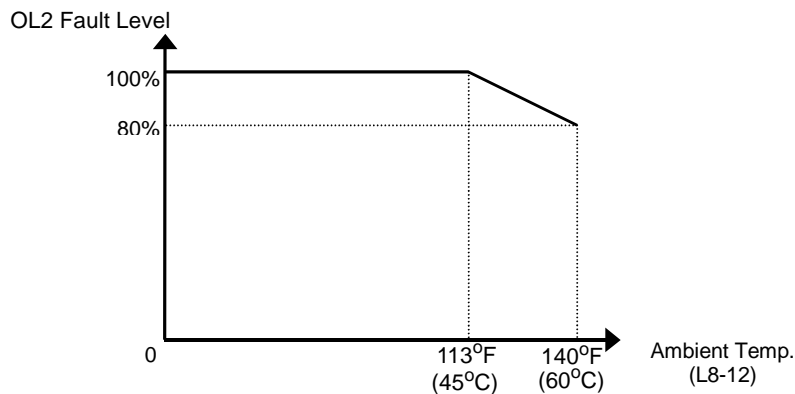

Fig. 85 Ambient Temperature Derating Curve

■ L8-15 OL2 Characteristic Selection at Low Speeds

Setting	Description
0	Disabled
1	Enabled (L8-18 is active) (factory default)

At very low speeds (6 Hz and below) and very high current levels it can be possible to damage output transistors. Therefore the factory default setting of L8-15 is to shorten the time before an OL2 fault will occur during low speed/high load situations (L8-15= “1: Enabled”).

■ L8-18 Soft CLA Selection

Setting	Description
0	Disabled
1	Enabled (<i>factory default</i>)

The Soft CLA (software current limit level) is a Drive protection function that will limit the Drive's output current. The Drive limits the output current by reducing the output frequency whenever the current exceeds 110% of the inverter rated current. If the current level drops below the Soft CLA level, then normal operation will continue.

If the software current limit is disabled (L8-18= "0: Disabled"), the Drive may trip on an OC fault if the load is prohibitively large or the acceleration is too short. For proper Drive protection and operation leave the Soft CLA function enabled.

■ L8-19 Overheat Frequency Reference Reduction Level

Setting Range: 0.0 to 100.0% of maximum frequency

Factory Default: 20.0% of maximum frequency

When the heatsink temperature reaches the OH Pre-alarm level (L8-02) and the Overheat Pre-Alarm Operation Selection parameter is set for Alarm and Reduce (L8-03= "4: OH Alarm & Reduce"), the L8-19 parameter sets the amount of speed decrease that will be applied to the Speed Command in order to lower the heatsink temperature. The decrease in speed will lower the current being switched and conducted by the heat producing output transistors of the Drive.

Parameter L8-19 is set in percentage of maximum frequency (E1-04).

◆ n1 Hunting Prevention

■ n1-01 Hunting Prevention Selection

Setting	Description
0	Disabled
1	Enabled (<i>factory default</i>)

■ n1-02 Hunting Prevention Gain Setting

Setting Range: 0.00 to 2.50

Factory Default: 1.00

Sometimes when the Drive is lightly loaded and the carrier frequency is high, the Drive's output current may vary, or hunt. This varying current can cause the motor to vibrate. The Drive's Hunting Prevention function can stabilize the motor's magnetizing current by adjusting the output voltage (n1-01= "1: Enabled"). The Hunting Prevention function can eliminate the vibration but at the cost of Drive response.

Parameter n1-02 can adjust the gain of the Hunting Prevention function if it is enabled by n1-01. Normally there is no need to adjust n1-02 from the factory default setting. Make adjustments in the following cases:

- If vibration occurs with a light load, increase the setting of n1-02.
- If the motor stalls, reduce the setting of n1-02.

An overly large Hunting Prevention Gain (n1-02) may cause the motor to stall.

◆ n3 High Slip Braking

High slip braking (HSB) is a method of decreasing the stopping time of a load without using dynamic braking. The regenerated energy of the decelerating load is dissipated in the motor windings through increased motor slipping. Because of the increased temperature of the motor windings, there is a limitation on the occurrence of HSB usage (~5% duty cycle). The stopping time using HSB is approximately 50% of what can be done with the standard braking methods. HSB can be activated by closing a digital input configured as a High Slip Braking input (H1-0x=68). The HSB digital input has priority over an active Run input and will be implemented immediately. HSB is only applied to stopping the motor and load and cannot be used for changing speeds. HSB can only be activated when the output frequency is greater than 6 Hz. When a HSB command is given it is not possible to restart the Drive until the motor is stopped and the Run command is cycled.

IMPORTANT

It is very important that Auto-tuning is performed before High Slip Braking is attempted. The Drive should be Auto-tuned again if the motor or cable length is changed since the last Auto-tuning.

■ n3-01 High-Slip Braking Deceleration Frequency Width

Setting Range: 1 to 20% of maximum frequency

Factory Default: 5% of maximum frequency

Parameter n3-01 sets the amount of frequency reduction that will be applied in order to create the increase motor slip condition and lower the DC Bus voltage. Normally this parameter will not need to be adjusted from the factory default. If the OV fault occurs during HSB increase n3-01 in small increments (~2% per adjustment). n3-01 is set as a percentage of the maximum frequency (E1-04).

■ n3-02 High-Slip Braking Current Limit

Setting Range: 100 to 200% of Drive rated output current

Factory Default: 150% of Drive rated output current

Parameter n3-02 sets the maximum current to be output during an HSB stop. The higher n3-02 is set the shorter the motor stopping time will be but the greater the motor winding heating will be. Increasing the setting of n3-02 should only be done in small increments. Parameter n3-02 is set as a percentage of motor rated current (E2-01).

■ n3-03 High-Slip Braking Dwell Time at Stop

Setting Range: 0.0 to 10.0 Seconds

Factory Default: 1.0 Seconds

At the end of a HSB action the Drive will hold the frequency reference at the minimum frequency (E1-09) for a period of time configured by parameter n3-03. If n3-03 is set too short there may be residual motion of the motor shaft after the HSB braking has completed and the Drive output is shut off. The residual motion can be caused by machine/load inertia.

■ n3-04 High-Slip Braking Overload Time

Setting Range: 30 to 1200 Seconds

Factory Default: 40 Seconds

The OL7 (HSB Overload) fault will occur if the Drive frequency does not change within the time specified by the n3-04 parameter. The non-changing frequency can be caused by a load with excessive inertia or a motor that is being overhauled by the load. A good test for the excessive load inertia is whether the Drive can stop the load normally (w/o a braking resistor but not with HSB) in 180 seconds or less.

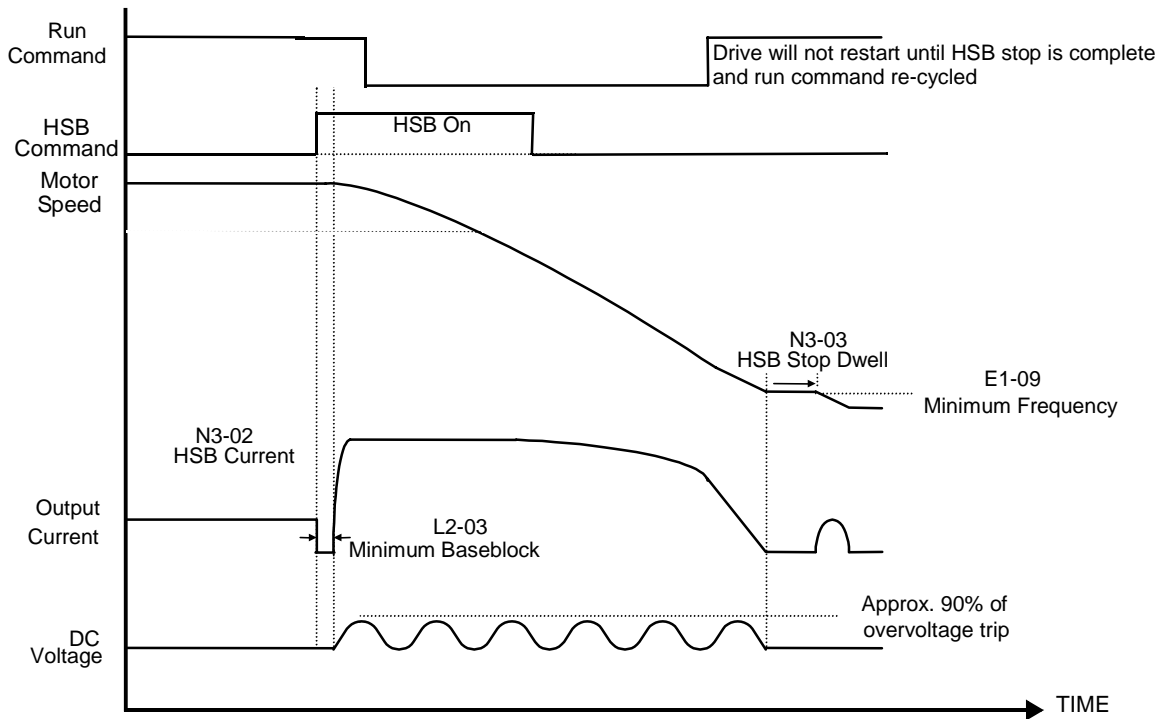

Fig. 86 High Slip Braking Timing Diagram

◆ o1 Monitor Configuration

■ o1-01 User Monitor Selection

Setting Range: 6 to 53

Factory Default: 6

Setting	Description
6	Output Voltage (<i>factory default</i>)
7	DC Bus Voltage
8	Output Power
10	Input Terminal Status
11	Output Terminal Status
12	Drive Operation Status
13	Cumulative Operation Time
14	Software Number
15	Terminal A1 Input Voltage
16	Terminal A2 Input Voltage
18	Motor Secondary Current (I_q)
20	Output Frequency After Soft Start
24	PI Feedback Value
28	CPU Number
34	First Parameter Causing an OPE
36	PI Input
37	PI Output
38	PI Setpoint
39	Memobus Communication Error Code
40	Heatsink Cooling Fan Operation Time
51	Auto Mode Frequency Reference Value
52	Hand Mode Frequency Reference Value
53	PI Feedback 2 Value

■ o1-02 Power-On Monitor

Setting	Description
1	Frequency Reference (<i>factory default</i>)
2	Output Frequency
3	Output Current
4	User Monitor (set by o1-01)

When the Drive is powered up, three monitors are displayed on the digital operator. The first and largest monitor is the “Power-On” monitor. The factory default “Power-On monitor” is Speed Command (U1-01). Below the Speed Command monitor are the next two sequential monitors, Output Frequency (U1-02) and Output Current (U1-03). Pressing the INCREASE key once scrolls the monitors to show the User Monitor as selected by o1-01. The factory default for o1-01 is the Output Voltage monitor (U1-06).

The active monitor displayed when the Drive is powered on can be changed to either be U1-01 (Speed Command), U1-02 (Output Frequency), U1-03 (Output Current), or the User Monitor. Whichever monitor is selected as the Power-On top monitor, the two monitors displayed below it are the next two sequential monitors. See example below.

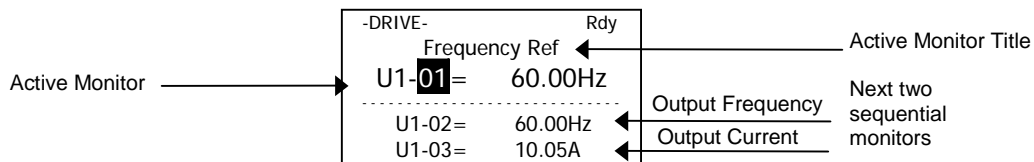

For example, if the Drive needs to display the Elapsed Timer as the Power-On monitor, then o1-01 must be set to “13” and o1-02 must be set to “4”. The next time Drive power is cycled, the digital operator displays U1-13 (Elapsed Time), U1-14 (Flash ID), and U1-15 (Term AI Level).

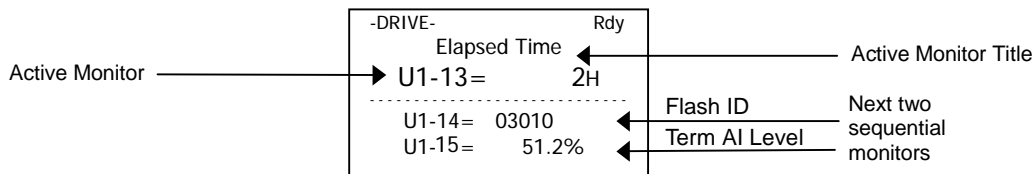

■ o1-03 Digital Operator Display Scaling

Setting	Description
0	Hz (<i>factory default</i>)
1	%
2 - 39	RPM (Enter the # of Motor Poles)
40 - 39999	User Display

Parameter o1-03 allows the programmer to change the units in which the speed monitors and some speed parameters are displayed. The o1-03 parameter will change the units of the following:

- U1-01 (Frequency Reference Monitor)
- U1-02 (Output Frequency Monitor)
- U1-20 (Output Frequency after Soft Start)
- d1-01 through d1-17 (Preset Frequency References and Jog Reference)

The table below details how the setting of o1-03 will affect the way the listed monitors and parameters will be displayed.

If o1-03 is:	The frequency format is
0	0.01 Hz
1	0.00%
2 through 39 (enter the # of motor poles)	0 RPM
40 through 39999	Engineering Units

The factory default setting (o1-03= “0”) sets the Drive up to display the affected monitors and parameters in terms of hertz (Hz).

If the speeds seem more natural in terms of percentage of maximum, set o1-03= “1”. If the speeds are easier to work with when displaying the equivalent synchronous motor RPM, set o1-03= [the number of motor poles]. If another engineered unit, such as fpm or gpm, is desired, set o1-03= xxxx where

 X X X X X
 Digit 5 Digit 4 Digit 3 Digit 2 Digit 1

Digits 1 through 4 set the desired number to be displayed at 100% speed.
 Digit 5 determines the number of decimal places in the displayed number.

If Digit 5 = 0 number format is XXXX
 If Digit 5 = 1 number format is XXX.X
 If Digit 5 = 2 number format is XX.XX
 If Digit 5 = 3 number format is X.XXX

For example:

If o1-03= 10425, then at full speed the digital operator will display “42.5”. Configuring parameter o1-03 for displaying in terms of an engineering unit is only appropriate if the actual display units have a linear relationship with the actual output speed.

■ o1-05 LCD Contrast Adjustment

Setting Range: 1, 3 or 5

Factory Default: 3

The contrast setting of the LCD display of the digital operator can be adjusted by the setting of parameter o1-05. The higher the number programmed into o1-05, the darker the background will become. Set o1-05 to the value that makes the LCD the easiest to view at the normal viewing distance and angle.

■ o1-06 User Monitor Selection Mode

Setting	Description
0	3 Mon Sequential (<i>factory default</i>)
1	3 Mon Selectable

■ o1-07 Second Line User Monitor

Setting Range: 1 to 53

Factory Default: 2

■ o1-08 Third Line User Monitor

Setting Range: 1 to 53

Factory Default: 3

Normally the monitors shown directly below the active monitor are the next two sequential monitors. If o1-06 (User Monitor Selection Mode) is set to “1: 3 Mon Selectable”, those two monitors are locked as specified by parameters o1-07 and o1-08 and will not change as the top parameter is scrolled with the INCREASE and DECREASE keys.

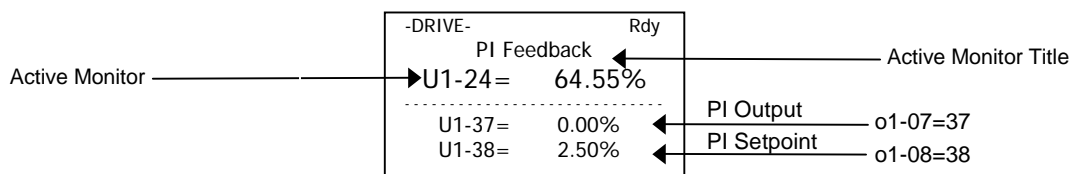

For Example:

The Display above showing PI Feedback, PI Output and PI Setpoint would be useful when setting up a PI Control Loop.

◆ o2 Key Selections

■ o2-01 Local/Remote Key Selections

Setting	Description
0	Disabled
1	Enabled (<i>factory default</i>)

The o2-01 parameter will have no effect on the operation of the Drive when the HOA (Hand/Off/Auto) keypad is used. If an optional non-HOA keypad is used with the Drive, parameter o2-01 determines whether the Local/Remote switch on the digital operator will be enabled and will switch between keypad operation and the sources specified by the b1-01 and b1-02 parameters when the Drive is stopped.

■ o2-02 OFF Key Function During Auto Run

Setting	Description
0	Disabled
1	Enabled (<i>factory default</i>)

The factory default setting of the OFF Key Function During Auto Run parameter (o2-02= “1: Enabled”) enables the OFF key on the digital operator even if b1-02 specifies the Run command source for the Auto mode as not coming from the digital operator. In effect the OFF key becomes an alternative Stop input. Once the Drive has been stopped by the OFF key it can be restarted either by cycling the external Run command or pressing the Auto key. If o2-02= “0: Disabled”, pressing the OFF key while in the Auto mode will have no effect.

■ o2-03 User Parameter Default Value

Setting	Description
0	No Change
1	Set Defaults
2	Clear All

The Drive gives the option of configuring any and all of the programming parameters and then saving the parameters as “User Initialization Values”. After configuring the Drive, set parameter o2-03= “1: Set Defaults”, to save the parameters to a User Initialization memory location. Once this has been done, the “Initialize Parameters” parameter (A1-03) will offer the choice of “1110:User Initialize”. Choosing A1-03= “1110: User Initialized”, will reset all modified parameters back to what they were the last time they were saved using o2-03.

The choice of setting A1-03= “1110: User Initialized”, is unavailable until first setting the User Initialization parameters using o2-03. Once a User Initialization is set (saved), it can be cleared by setting o2-03= “2: Clear All”. After clearing the User Initialization parameters, the choice of “1110: User Initialize” is no longer a available in A1-03.

■ o2-04 Drive / kVA Selection

Setting Range: 0 to FF

Factory Default: Model Dependent

Parameter o2-04 matches the control board to the Drive hardware. Proper setting of o2-04 is important so that the control board can provide proper protection for the Drive hardware. This parameter is configured at the factory and does not normally require adjustment in the field. It is available primarily to accommodate control board replacement in the event of damage.

208-230/240Vac		480Vac	
Model Number	Proper o2-04 Setting	Model Number	Proper o2-04 Setting
20P4	0	40P4	20
20P7	1	40P7	21
21P5	2	41P5	22
22P2	3	42P2	23
23P7	4	43P7	24
27P5	6	45P5	26
2011	7	47P5	27
2015	8	4011	28
2018	9	4015	29
2022	A	4018	2A
2030	B	4030	2C
2037	C	4037	2D
2045	D	4045	2E
2055	E	4055	2F
2075	F	4075	30
2090	10	4090	31
2110	11	4110	32
		4160	34
		4185	35
		4220	36
		4300	37

The factory defaults of the following parameters may be changed when the setting of o2-04 is changed:

- b8-04 (Energy Saving Coefficient Value)
- C6-02 (Carrier Frequency Selection)
- E2-01 (Motor Rated Current)
- E2-03 (Motor No-Load Current)
- E2-05 (Motor Line-to-Line Resistance)
- L2-02 (MPL Ride-Thru Time)
- L2-03 (MPL Minimum Base Block Time)
- L2-04 (MPL Voltage Recovery Ramp Time)
- L8-02 (Overheat Pre-Alarm Level)
- L8-06 (Input Phase Loss Detection Level)

■ o2-05 Frequency Reference Setting Method Selection

Setting	Description
0	Disabled
1	Enabled (<i>factory default</i>)

The factory default setting of the Frequency Reference Setting Method parameter (o2-05= “1: Enabled”) dictates that when setting a Speed Command via the digital operator (“Hand” mode), it is not necessary to press the DATA/ENTER key before the Drive will begin to accelerate or decelerate to the new set speed. This is referred to as MOP (Motor Operated Potentiometer) type functionality. When o2-05= “1: Enabled”, the speed command is stored to memory 5 seconds after the INCREASE or DECREASE keys are released.

When o2-05= “0: Disabled”, the digital operator INCREASE and DECREASE keys will change the speed command but the Drive will not accelerate or decelerate to the new speed command until the DATA/ENTER key is pressed. In order to change the Speed Command in the HAND mode, U1-01 must be the top monitor and then the ENTER key must be pressed in order to access the Speed Command function. This is not to be confused with pressing the ENTER key in order to achieve a change in speed using the INCREASE and DECREASE keys, which is the subject of parameter o2-05.

■ o2-06 Operation Selection when Digital Operator is Disconnected

Setting	Description
0	Disabled
1	Enabled (<i>factory default</i>)

Leaving o2-06 enabled will cause the Drive to fault, when the digital operator is removed, even if it's not outputting to the motor. The reset key on the digital operator will need to be pressed after reconnecting the digital operator to reset the fault and continue normal operation.

If o2-06 = "0: Disabled" then the Drive will not fault if the digital operator is disconnected, but the Drive will discontinue motor operation. If full Drive operation is required while the digital operator is removed set o2-06 = "0: Disabled" and o2-15 = "0: Disabled" (Hand Key Function). If both o2-06 and o2-15 are disabled then the digital operator can be disconnected without disturbing Drive operation.

■ o2-07 Cumulative Operating Time Setting

Setting Range: 0 to 65535 Hours
 Factory Default: 0 Hours

■ o2-08 Cumulative Operation Time Selection

Setting	Description
0	Power-On Time
1	Running Time (<i>factory default</i>)

The Drive features an Elapsed Timer monitor that records in units of hours. The Elapsed Timer monitor is U1-13. Parameter o2-08 programs this function to either accumulate elapsed hours based on time the Drive is powered (o2-08= "0: Power-On Time") or time the Drive is running (o2-08= "1: Running Time"). The Drive is considered "running" anytime there is an active run command or when the Drive is outputting voltage (i.e. including during deceleration).

-DRIVE-	Rdy
Elapsed Time	
U1-13= 0H	

U1-14= 03010	
U1-15= 34.1%	

Parameter o2-07 allows manual adjustment of the Elapsed Timer, primarily to accommodate maintenance or control board replacement in the event of damage. To reset the Elapsed Timer back to zero, set o2-07= 0.

■ o2-09 Initialization Specification Selection

Setting	Description
1	American Spec (<i>factory default</i>)
2	European Spec
4	PV-A Spec
5	PV-E Spec

Different regions of the world have different electrical standards. The Drive's factory defaults may be perfect for one region and improper for another. The o2-09 parameter allows the programmer to change en mass most parameter defaults to reflect best the region where the Drive will be installed and operated.

After a change has been made in parameter o2-09, the Drive should be re-initialized by parameter A1-03 to complete the change to a new specification.

The parameters that are changed by o2-09 are:

Parameter Number	Parameter Description	European Specifications (o2-09=2)	American Specifications (o2-09=1)
b1-04	Reverse Operation Sel	0 (Reverse Enabled)	1 (Reverse Disabled)
b2-04	DCInj Time @ Stop	0.5sec	0.0sec
b5-02	PI(D) P gain	1	2
b5-03	PI(D) I time	1.0sec	5.0sec
C1-01	Accel time 1	10.0sec	30.0sec
C1-02	Decel time 1	10.0sec	30.0sec
C1-03	Accel time 2	10.0sec	30.0sec
C1-04	Decel time 2	10.0sec	30.0sec
C1-09	Fast stop	10.0sec	30.0sec
E1-01	Input voltage	200/400VAC	240/480VAC
E1-04	Max. Frequency	50.0Hz	60.0Hz
E1-05	Max. Voltage	200/400VAC	240/480VAC
E1-06	Base Frequency	50.0Hz	60.0Hz
H2-02	M3-M4 function	1 (Zero speed)	A (Run from operator)
H3-09	A2 function	0 (Freq. Bias)	2 (Aux. Ref.)
L2-01	Momentary UV detection	0 (Disabled: UV1)	2 (As long as possible)
L5-03	Fault retry cont. time	10.0sec	180.0sec
L6-01	Torque detection Sel. 1	6 (UL1 warning)	0 (Disabled)
o2-05	Freq. Ref setting method	0 (with ENTER key)	1 (without ENTER key)

■ o2-10 Cumulative Cooling Fan Operation Time Setting

Setting Range: 0 to 65535 Hours

Factory Default: 0 Hours

The elapsed time of heatsink cooling fan operation is tracked by the U1-40 monitor. Much like the o2-07 parameter can be used to adjust or reset the Drive operation elapsed timer, parameter o2-10 can be used to adjust the time displayed by the U1-40 monitor in the event of fan replacement.

-DRIVE-	Rdy
FAN Elapsed Time	
U1-40=	152H

U1-51=	52.33%
U1-52=	57.60%

■ o2-12 Fault Trace / Fault History Clear Function

Setting	Description
0	Disabled (No Effect) (<i>factory default</i>)
1	Enabled

The operator can clear the Fault Trace (U2) and Fault History logs by setting o2-12= “1: Enabled”. Clearing the Fault Trace and Fault History logs erases all the information.

■ o2-14 kWh User Monitor Initialization

Setting	Description
0	Disabled (No Change) (<i>factory default</i>)
1	Clear All

The kWh monitors (U1-29 and U1-30) track the power usage of the Drive and are not reset by powering down the Drive. To reset the monitors back to zero, set o2-14= “1: Clear all”.

■ o2-15 Hand Key Function Selection

Setting	Description
0	Disabled
1	Enabled (<i>factory default</i>)

To disable the use of the Hand button on the digital operator, set o2-15= “0: Disabled”. Once the Hand Key is disabled the Drive will not transfer to Hand and Run when the Hand key is pressed.

◆ o3 Digital Operator Copy Function

■ o3-01 Copy Function Selection

Setting	Description
0	COPY SELECT (<i>factory default</i>)
1	INV→OP READ
2	OP→INV WRITE
3	OP↔INV VERIFY

Note: The copy function is disabled when serial communication is active.

■ o3-02 Read Allowed Selection

Setting	Description
0	Disabled (<i>factory default</i>)
1	Enabled

The digital operator has parameter COPY capabilities via built in non-volatile memory. The digital operator can READ all of the parameters in the Drive and store them for later WRITE back to the Drive or into a Drive with the same product code and software number. In order to read the parameter values and store them in the digital operator, select o3-02= “1: Enabled”. If you attempt to READ the data, which overwrites any previously stored data, without first setting o3-02= “1: Enabled”, you will get the following error:

-ADV- PRE READ IMPOSSIBLE

After setting o3-02= “1: Enabled”, it is possible to store parameter values in the digital operator by setting o3-01=1 (INV→OP READ).

A successful READ of the parameter values will display:

-ADV- READ READ COMPLETE

An error may occur while saving the parameter values to the digital operator’s memory. If an error is displayed, press any key to cancel the error display and return to parameter o3-01. Error displays and their meanings are covered in *Chapter 6: Diagnostics and Troubleshooting* of the E7 Users Manual (TM.E7.01). To COPY parameter values into a Drive, set o3-01= “2: OP→INV WRITE”. During the writing of the parameter values into the Drive the digital operator will display:

-ADV-
COPY
OP→INV COPYING

A successful COPY of the parameter values will display:

-ADV-
COPY
COPY COMPLETE

An error may occur while writing the parameter values to the Drive. If an error is displayed, press any key to cancel the error display and return to parameter o3-01. Error displays and their meanings are covered in *Chapter 6: Diagnostics and Troubleshooting* of the E7 Users Manual (TM.E7.01).

It is possible to compare the parameter values stored in the digital operator with the parameter values currently in the Drive by using the VERIFY function. This VERIFY function should not be confused with the “-VERIFY-“ that is displayed on the digital operator when viewing the “Modified Constants” menu. To VERIFY the parameter values in the Drive as compared with those stored in the digital operator, set o3-01= “3: OP<-->INV VERIFY”. During the comparing of the parameter values into the Drive the digital operator will display:

-ADV-
VERIFY
DATA VERIFYING

A successful VERIFY of the parameter values will display:

-ADV-
VERIFY
VERIFY COMPLETE

If all the parameter values stored in the digital operator do not match those programmed in the Drive, the digital operator displays the following:

-ADV-

VYE
VERIFY ERROR

The digital operator will not display which parameters did not match, only that the verification found discrepancies in some parameter values.

NOTE: In order to properly use the COPY or VERIFY functions, the following Drive specifications must be identical between the Drive that the parameters were read from and the Drive that the parameters are to be written to:

- Model Number (e.g. CIMR-E7U2015)
- Software Number (e.g. 03011 also known as FLASH ID)

Yaskawa offers DriveWizard™ software that can also READ, COPY, and VERIFY Drive parameter values. DriveWizard™ lists all discrepancies between the Drive and a pre-saved parameter file when verifying is performed.

To use DriveWizard first select o2-15= “0: Disabled” and select o2-06= “0: Disabled” then remove the digital operator/keypad and attach the DriveWizard cable in its place.

◆ T1 Auto-Tuning

■ T1-02 Motor Rated Power

Setting Range: 0.00 to 650.00 kW
Factory Default: Model Dependent

■ T1-04 Motor Rated Current

Setting Range: Model Dependent
Factory Default: Model Dependent

Auto tuning is recommended to achieve optimum performance. In addition, the Drive requires Line-To-Line Resistance auto-tuning before it can properly perform the Estimated Speed Search method. This method of speed search allows for bi-directional speed search. The T1 parameters are found under the Auto-Tuning menu.

To perform auto-tuning follow these steps:

1. T1-02 should be left at the default value (the last 3 digits of the Drive model number).
2. In T1-04, enter the Full Load Amps (FLA) as stamped on the motor's nameplate.
3. Press the INCREASE key once to display this:

-ATUNE-	Rdy
Auto-Tuning	

0Hz/ 0.00A	
Tuning Ready ?	
Press HAND key	

4. If ready, press the HAND key once to start auto-tuning. This process will last for approximately 15 seconds. Once auto-tuning is finished, the digital operator will display this:

-ATUNE-
Tune Successful

0Hz/ 0.00A

5. To exit the Auto-Tuning menu, press the MENU key once.

NOTE: It is possible to get a "Data Invalid" error if either T1-02 or T1-04 fall outside the range of what the Drive will accept as reasonable levels for the programmed size of drive (o2-04).

Notes:

Appendix A

Parameters

This appendix lists all the parameter numbers and names, along with a description of each. Also, below the parameter name in bold type is the abbreviated name as it appears on the digital operator display/keypad.

Parameter List	2
Monitor List	26
Fault Trace List	28
Fault History List	29

Parameter List

Table A.1 Parameter List

Parameter No.	Parameter Name Digital Operator Display	Description	Setting Range	Factory Setting	Menu Location
Initialization					
A1-00 ◆	Language Selection Select Language	Language selection for digital operator display. 0: English 2: Deutsch 3: Francais 4: Italiano 5: Espanol 6: Portugues *Not returned to factory setting by initialization	0 to 6	0	Programming
A1-01 ◆	Access Level Selection Access Level	This setting determines which parameters are accessible. 0: Operation Only 1: User Level 2: Advanced Level	0 to 2	2	Programming
A1-03	Initialize Parameters Init Parameters	Used to return all parameters to their factory or user setting. 0: No Initialize 1110: User Initialize (The user must set their own parameter default values and then parameter o2-03 must be set to "1" to save them. If the parameter values are changed after o2-03 is set to "1", the user default values can be restored by setting A1-03 to 1110.) 2220: 2-Wire Initial 3330: 3-Wire Initial	0 to 3330	0	Programming
A1-04	Password 1 Enter Password	When the value set into A1-04 does NOT match the value set into A1-05, parameters A1-01 thru A1-03 and A2-01 thru A2-32 cannot be changed. All other parameters as determined by A1-01 can be changed. Parameter A1-05 can be accessed by pressing the MENU key while holding the RESET key.	0 to 9999	0	Programming
A1-05	Password 2 Select Password		0 to 9999	0	Programming
User Parameters					
A2-01	User Parameter 1 User Param 1	Selects the parameters to be available in the User Access Level (A1-01 = 1). These are the only parameters accessible for the user level. These parameters are not related to the User Initialize function.	b1-01 to o3-02	—	Programming
A2-02	User Parameter 2 User Param 2			—	Programming
A2-03	User Parameter 3 User Param 3			—	Programming
A2-04	User Parameter 4 User Param 4			—	Programming
A2-05	User Parameter 5 User Param 5			—	Programming
A2-06	User Parameter 6 User Param 6			—	Programming
◆Denotes that parameter can be changed when the Drive is running.					

Table A.1 Parameter List (Continued)

Parameter No.	Parameter Name Digital Operator Display	Description	Setting Range	Factory Setting	Menu Location
A2-07	User Parameter 7 User Param 7	Selects the parameters to be available in the User Access Level (A1-01 = 1). These are the only parameters accessible for the user level. These parameters are not related to the User Initialize function.	b1-01 to o3-02	—	Programming
A2-08	User Parameter 8 User Param 8			—	Programming
A2-09	User Parameter 9 User Param 9			—	Programming
A2-10	User Parameter 10 User Param 10			—	Programming
A2-11	User Parameter 11 User Param 11			—	Programming
A2-12	User Parameter 12 User Param 12			—	Programming
A2-13	User Parameter 13 User Param 13			—	Programming
A2-14	User Parameter 14 User Param 14			—	Programming
A2-15	User Parameter 15 User Param 15			—	Programming
A2-16	User Parameter 16 User Param 16			—	Programming
A2-17	User Parameter 17 User Param 17			—	Programming
A2-18	User Parameter 18 User Param 18			—	Programming
A2-19	User Parameter 19 User Param 19			—	Programming
A2-20	User Parameter 20 User Param 20			—	Programming
A2-21	User Parameter 21 User Param 21			—	Programming
A2-22	User Parameter 22 User Param 22			—	Programming
A2-23	User Parameter 23 User Param 23			—	Programming
A2-24	User Parameter 24 User Param 24			—	Programming
A2-25	User Parameter 25 User Param 25			—	Programming
A2-26	User Parameter 26 User Param 26			—	Programming
A2-27	User Parameter 27 User Param 27			—	Programming
A2-28	User Parameter 28 User Param 28			—	Programming
A2-29	User Parameter 29 User Param 29			—	Programming
A2-30	User Parameter 30 User Param 30			—	Programming
A2-31	User Parameter 31 User Param 31			—	Programming
A2-32	User Parameter 32 User Param 32			—	Programming

Table A.1 Parameter List (Continued)

Parameter No.	Parameter Name Digital Operator Display	Description	Setting Range	Factory Setting	Menu Location
Sequence					
b1-01	Frequency Reference Selection Reference Source	Selects the speed command (frequency reference) input source. 0: Operator - Digital preset speed d1-01 1: Terminals - Analog Input Terminal A1 (or Terminal A2 see parameter H3-13) 2: Serial Com - RS-485 terminals R+, R-, S+ and S- 3: Option PCB - Option board connected at 2CN	0 to 3	1	Quick Setting
b1-02	Run Command Selection Run Source	Selects the run command input source. 0: Operator - "Hand" and "Off" keys on digital operator 1: Terminals - Contact Closure on Terminal S1 2: Serial Com - RS-485 terminals R+, R-, S+ and S- 3: Option PCB - Option board connected at 2CN	0 to 3	1	Quick Setting
b1-03	Stopping Method Selection Stopping Method	Selects the stopping method when the run command is removed. 0: Ramp to Stop 1: Coast to Stop 2: DC Injection to Stop 3: Coast w/Timer (A new run command is ignored if input before the time in C1-02 expires.)	0 to 3	0	Quick Setting
b1-04	Reverse Operation Selection Reverse Oper	Determines the forward rotation of the motor, and if reverse operation is disabled. 0: Reverse Enabled 1: Reverse Disabled 2: Exchange Phase - Change direction of forward motor rotation. 3: Exchange Phase, Reverse Disabled - Change direction of forward motor rotation and disable reverse operation.	0 to 3	1	Programming
b1-07	Local/Remote Run Selection LOC/REM RUN Sel	0: Cycle External RUN - If the run command is closed when switching from hand(local) mode to auto(remote) mode, the Drive will not run. 1: Accept External RUN - If the run command is closed when switching from hand(local) mode to auto(remote) mode, the Drive WILL run.	0 or 1	0	Programming
b1-08	Run Command Selection During Program RUN CMD at PRG	0: Disabled - Run command accepted only in the operation menu. 1: Enabled - Run command accepted in all menus (except when b1-02 = 0).	0 or 1	0	Programming
b1-11	Drive Delay Time Setting Wait to Run Time	After a run command, Drive output will start after this delay time.	0 to 600	0sec	Programming
b1-12	Hand Frequency Reference Selection HAND Fref Source	Selects the speed command input source in hand mode.* 0: Operator - Digital preset speed d1-01 1: Terminals - Analog Input Terminal A1 (or Terminal A2 see parameter H3-13)	0 or 1	0	Programming
b1-13	HAND/AUTO During Run Selection HAND/AUTO @Run	Selects if drive will permit switching between HAND and AUTO modes while running. 0: Disabled 1: Enabled	0 or 1	0	Programming
b1-14	Emergency Override Speed E Override Speed	Sets the speed command used in emergency override mode when b1-15=0.	0.00 to 120.00 Hz	0.00	Programming
b1-15	Emergency Override Reference Selection E OverrideRefSel	Selects the emergency override reverse source. 0: Use b1-14 Ref 1: Use AUTO Ref	0 or 1	0	Programming
DC Braking					
b2-01	DC Injection Braking Start Frequency DCInj Start Freq	Sets the frequency at which DC injection braking starts when ramp to stop (b1-03 = 0) is selected. If b2-01 < E1-09, DC Injection braking starts at E1-09.	0.0 to 10.0	0.5Hz	Programming
b2-02	DC Injection Braking Current DCInj Current	Selects the DC injection braking current as a percentage of the Drive rated current.	0 to 100	50%	Programming
b2-03	DC Injection Braking Time at Start DCInj Time @ Start	Sets the time length of DC injection braking at start in units of 1 second.	0.00 to 10.00	0.00sec	Programming
b2-04	DC Injection Braking Time at Stop DCInj Time @ Stop	When b1-03 = 2 actual DC Injection time is calculated as follows: b2-04 * 10 * Output Frequency / E1-04. When b1-03 = 0, this parameter determines the amount of time DC Injection is applied to the motor at the end of the decel ramp. This should be set to a minimum of 0.50 seconds when using HSB. This will activate DC injection during the final portion of HSB and help ensure that the motor stops completely.	0.00 to 10.00	0.00sec	Programming
* If b1-13=1, this parameter instead selects whether the AUTO reference is retained as the new HAND reference (setting=0), or the drive will ramp from the AUTO reference to the existing HAND reference (setting=1).					

Table A.1 Parameter List (Continued)

Parameter No.	Parameter Name Digital Operator Display	Description	Setting Range	Factory Setting	Menu Location
b2-09	Motor Pre-Heat Current Preheat Current	Motor Pre-heat current in % of Drive rated current. This is used to keep the motor warm to prevent condensation and is used in conjunction with a digital input (data = 60).	0 to100	0%	Programming
b2-10	Motor Pre-Heat Current 2 Preheat Current2	Sets the DC preheat current for multi-function output setting 80 (Motor Preheat 2) as a percentage of Motor Rated Current (E2-01).	0 to 10%	5	Programming
Speed Search					
b3-01	Speed Search Selection SpdSrch at Start	Enables/disables and selects the speed search function at start. 0: SpdsrchF Disable - Speed search at start is disabled (estimated speed method is used at other times) 1: SpdsrchF Enable - Speed search is enabled (estimated speed method) 2: SpdsrchI Disable - Speed search at start is disabled (current detection method is used at other times) 3: SpdsrchI Enable - Speed search is enabled (current detection method) Estimated Speed Method: Actual motor speed and direction is estimated, then the motor is ramped from that speed to the commanded speed. Current Detection Method: Current level is monitored while output frequency is ramped down.	0 to 3	2	Programming
b3-02	Speed Search Deactivation Current SpdSrch Current	Used only when b3-01 = 3. Sets the speed search operation current as a percentage of Drive rated current.	0 to 200	120%	Programming
b3-03	Speed Search Deceleration Time SpdSrch Dec Time	Used only when b3-01 = 3. Sets the deceleration time during speed search.	0.1 to 10.0	2.0sec	Programming
b3-05	Speed Search Delay Time Search Delay	Delays the speed search operation after a momentary power loss to allow time for an external output contactor to re-energize.	0.0 to 20.0sec	0.2sec	Programming
b3-14	Bidirectional Speed Search Selection Bidir Search Sel	0: Disabled 1: Enabled	0 or 1	1	Programming
Delay Timers					
b4-01	Timer Function ON-Delay Time Delay-ON Timer	Used in conjunction with a multi-function digital input and a multi-function digital output. This sets the amount of time between when the digital input is closed, and the digital output is energized.	0.0 to 3000.0	0.0sec	Programming
b4-02	Timer Function OFF-Delay Time Delay-OFF Timer	Used in conjunction with a multi-function digital input and a multi-function digital output. This sets the amount of time the output stays energized after the digital input is opened.	0.0 to 3000.0	0.0sec	Programming
PI Control					
b5-01	PI Mode Setting PI Mode	This parameter enables / disables the closed loop (PI) controller. 0: Disabled 1: Enabled (commanded speed becomes PI setpoint) 3: Fref+PI	0, 1, 3	0	Quick Setting
b5-02 ◆	Proportional Gain Setting P Gain	Sets the proportional gain of the PI controller.	0.00 to 25.00	2.00	Quick Setting*
b5-03 ◆	Integral Time Setting PI I Time	Sets the integral time for the PI controller. A setting of zero disables integral control.	0.0 to 360.0	5.0sec	Quick Setting*
b5-04 ◆	Integral Limit Setting PI I Limit	Sets the maximum output possible from the integrator. Set as a % of fmax.	0.0 to 100.0	100%	Programming
b5-06 ◆	PI Output Limit PI Limit	Sets the maximum output possible from the entire PI controller. Set as a % of fmax.	0.00 to 100.0	100.0%	Programming
b5-07 ◆	PI Offset Adjustment PI Offset	Sets the amount of offset of the output of the PI controller. Set as a % of fmax. The PI Offset Adjustment parameter has two different uses. Parameter b5-07 serves different functions depending on whether it is used on a standard PI loop or a Differential PI loop. 1: Parameter b5-07 causes an offset to be applied to the output of the PI function in a non-Differential PI loop. Every time the PI output is updated, the offset is summed with the PI output. This can be used to artificially kick-start a slow starting PI loop. 2: If the Drive is configured for Differential PI Regulation (H3-09=16), then the PI Offset is the targeted maintained differential between the signal measured on analog input A1 and the signal measured on analog input A2.	-100.0 to +100.0	0.0%	Programming

◆ Denotes that parameter can be changed when the drive is running. * Menu location is Quick Setting when b5-01=1, and Programming when b5-01=0.

Table A.1 Parameter List (Continued)

Parameter No.	Parameter Name Digital Operator Display	Description	Setting Range	Factory Setting	Menu Location
b5-08 ◆	PI Primary Delay Time Constant PI Delay Time	Sets the amount of time for a filter on the output of the PI controller.	0.00 to 10.00	0.00sec	Programming
b5-09	PI Output Level Selection Output Level Sel	Determines whether the PI controller will be direct or reverse acting. 0: Normal Output (direct acting) 1: Reverse Output (reverse acting)	0 or 1	0	Programming
◆Denotes that parameter can be changed when the Drive is running.					
b5-10	PI Output Gain Setting Output Gain	Sets the output gain of the PI controller.	0.0 to 25.0	1.0	Programming
b5-11	PI Output Reverse Selection Output Rev Sel	0: 0 limit (when PI output goes negative Drive stops) 1: Reverse (when PI goes negative Drive reverses) 0 limit automatic when reverse prohibit is selected using b1-04	0 or 1	0	Programming
b5-12	PI Feedback Reference Missing Detection Selection Fb los Det Sel	0: Disabled 1: Alarm 2: Fault	0 to 2	0	Programming
b5-13	PI Feedback Loss Detection Level Fb los Det Lvl	Sets the PI feedback loss detection level as a percentage of maximum frequency (E1-04).	0 to 100	0%	Programming
b5-14	PI Feedback Loss Detection Time Fb los Det Time	Sets the PI feedback loss detection delay time in terms of seconds.	0.0 to 25.5	1.0sec	Programming
b5-15	Sleep Function Start Level Sleep Level	Sets the sleep function start frequency.	0.0 to 200.0	0.0Hz	Programming
b5-16	Sleep Delay Time Sleep Time	Sets the sleep function delay time in terms of seconds.	0.0 to 25.5	0.0sec	Programming
b5-17	PI Accel/Decel Time Acc/Dec Time	Applies an accel/decel time to the PI setpoint reference.	0.0 to 25.5	0.0sec	Programming
b5-18	PI Setpoint Selection PI Setpoint Sel	0: Disabled 1: Enabled	0 or 1	0	Programming
b5-19	PI Setpoint Value PI Setpoint	*Depends on b5-20.	0.00 to 100.00**	0.00%	Programming
b5-20	PI Setpoint Display Scaling Setpoint Scaling	Set display/setting unit of b5-19, U1-24, and U1-38.	0 to 39999	1	Programming
b5-21	PI Sleep Input Source PI Sleep Source	Input Source Selection for Sleep function Mode. 0: PI Setpoint 1: SFS Input (This is near the PI Output) 2: Snooze	0 to 2	1	Programming
b5-22 ◆	PI Snooze Level Snooze Level	Sets the PI snooze function start level as a percentage of maximum frequency (E1-04).	0 to 100	0%	Programming
b5-23	PI Snooze Delay Time Snooze Delay Time	Sets the PI snooze function delay time in terms of seconds.	0 to 3600	0sec	Programming
b5-24	PI Snooze Deactivation Level Wake-Up Level	When the PI feedback drops below this level, normal PI operation starts again. Set as a percentage of maximum frequency (E1-04).	0 to 100	0%	Programming
b5-25	PI Setpoint Boost Setting Setpoint Boost	Temporary increase of PI setpoint to create an overshoot of the intended PI setpoint.	0 to 100	0%	Programming
b5-26	PI Maximum Boost Time Max Boost Time	Sets a time limitation for reaching temporarily boosted PI setpoint (intended PI setpoint + b5-25).	0 to 3600	0sec	Programming
b5-27	PI Snooze Feedback Level Snooze Feedback	PI snooze mode will be activated when PI feedback is above this level. Set as a percentage of maximum frequency (E1-04).	0 to 100	60%	Programming
◆Denotes that parameter can be changed when the drive is running. ** Range depends on b5-20 setting. Units depend on b5-31 setting.					

Table A.1 Parameter List (Continued)

Parameter No.	Parameter Name Digital Operator Display	Description	Setting Range	Factory Setting	Menu Location
b5-28	PI Feedback Square Root Function Selection PI Feedback SqRt	0: Disabled 1: Enabled	0 or 1	0	Programming
b5-29	PI Square Root Gain PI Fb SqRt Gain	A multiplier applied to the square root of the feedback.	0.00 to 2.00	1.00	Programming
b5-30	Output Square Root Monitor Selection PI Out Moni SqRt	0: Disabled 1: Enabled	0 or 1	0	Programming
b5-31	PI Unit Selection PI Unit Sel	Sets units for b5-19, U1-24, U1-38. 0: WC:InchOfWater 1: PSI:lb/SqrInch 2: GPM:Gallons/Min 3: F:DegFahrenheit 4: CFM:Cubic ft/Min 5: CMH:Cubic M/Hr 6: LPH:Liters/Hr 7: LPS:Liters/Sec 8: Bar:Bar 9: Pa:Pascals 10: C:DegCelsius 11: Mtr:Meters	0 to 11	0	Quick Setting*
Energy Saving					
b8-01	Energy Saving Control Selection Energy Save Sel	Energy Savings function enable/disable selection 0: Disabled 1: Enabled	0 or 1	0	Quick Setting
b8-04	Energy Saving Coefficient Value Energy Save COEF	Used to fine-tune the energy savings function.	0.0 to 655.00	kVA Dependent	Programming
b8-05	Power Detection Filter Time kW Filter Time		0 to 2000	20ms	Programming
b8-06	Search Operation Voltage Limit Search V Limit		0 to 100	0%	Programming
Accel / Decel					
C1-01 ◆	Acceleration Time 1 Accel Time 1	Sets the time to accelerate from zero to maximum frequency.	0.0 to 6000.0	30.0sec	Quick Setting
C1-02 ◆	Deceleration Time 1 Decel Time 1	Sets the time to decelerate from maximum frequency to zero.		30.0sec	Quick Setting
C1-03 ◆	Acceleration Time 2 Accel Time 2	Sets the time to accelerate from zero to maximum frequency when selected via a multi-function input.		30.0sec	Programming
C1-04 ◆	Deceleration Time 2 Decel Time 2	Sets the time to decelerate from maximum frequency to zero when selected via a multi-function input.		30.0sec	Programming
C1-09	Fast Stop Time Fast Stop Time	Sets the time to decelerate from maximum frequency to zero for the "Fast Stop" function.	0.0 to 6000.0	10.0sec	Programming
C1-11	Accel/Decel Switch Frequency Acc/Dec SW Freq	Sets the frequency for automatic switching of accel / decel times. Fout < C1-11: Accel/Decel Time 2 Fout >= C1-11: Accel/Decel Time 1 Multi-function input "Multi-Acc/Dec 1" has priority over C1-11.	0.0 to 200.0	0.0Hz	Programming
◆ Denotes that parameter can be changed when the Drive is running. * Menu location is Programming when PI is disabled and Quick Setting when PI is enabled.					

Table A.1 Parameter List (Continued)

Parameter No.	Parameter Name Digital Operator Display	Description	Setting Range	Factory Setting	Menu Location
S-Curve Acc/Dec					
C2-01	S-Curve Characteristic at Accel Start SCrv Acc @ Start	S-curve is used to further soften the starting ramp. The longer the S-curve time, the softer the starting ramp.	0.00 to 2.50	0.20sec	Programming
C2-02	S-Curve Characteristic at Accel End SCrv Acc @ End		0.00 to 2.50	0.20sec	Programming
Torque Comp					
C4-01 ◆	Torque Compensation Gain Torq Comp Gain	This parameter helps to produce better starting torque. It determines the amount of torque or voltage boost based upon motor current and motor resistance.	0.00 to 2.50	1.00	Programming
C4-02	Torque Compensation Primary Delay Time Torq Comp Time	This parameter adjusts a filter on the output of the torque compensation function. Increase to add torque stability, decrease to improve torque response.	0 to 10000	200ms	Programming
Carrier Freq					
C6-01	Normal Duty Selection Normal Duty Sel	1: Normal Duty 1 2: Normal Duty 2	1 or 2	2	Programming
C6-02	Carrier Frequency Selection CarrierFreq Sel	Carrier frequency sets the number of pulses per second of the output voltage waveform. 0: Low Noise (Carrier frequency is randomly modulated for lower audible noise) 1: Fc = 2.0 kHz 2: Fc = 5.0 kHz 3: Fc = 8.0 kHz 4: Fc = 10.0 kHz 5: Fc = 12.5 kHz 6: Fc = 15.0 kHz F: Program (Determined by the settings of C6-03 thru C6-05)	0 to F	kVA Dependent	Programming
C6-03	Carrier Frequency Upper Limit CarrierFreq Max	Maximum carrier frequency allowed when C6-02 = F.	0.4 to 15.0 kHz	kVA Dependent	Programming
C6-04	Carrier Frequency Lower Limit CarrierFreq Min	Minimum carrier frequency allowed when C6-02 = F.	0.4 to 15.0 kHz	kVA Dependent	Programming
C6-05	Carrier Frequency Proportional Gain CarrierFreq Gain	Sets the relationship of output frequency to carrier frequency when C6-02 = F.	0 to 99	0	Programming
Preset Reference					
d1-01 ◆	Frequency Reference 1 Reference 1	Digital preset speed command 1. Used when b1-01 = 0 and when in "hand" mode. Setting units are affected by o1-03.	0.00 to E1-04 Value	0.00Hz	Programming
d1-02 ◆	Frequency Reference 2 Reference 2	Digital preset speed command 2. Selected via multi-function input terminals. Setting units are affected by o1-03.		0.00Hz	Programming
d1-03 ◆	Frequency Reference 3 Reference 3	Digital preset speed command 3. Selected via multi-function input terminals. Setting units are affected by o1-03.		0.00Hz	Programming
d1-04 ◆	Frequency Reference 4 Reference 4	Digital preset speed command 4. Selected via multi-function input terminals. Setting units are affected by o1-03.		0.00Hz	Programming
d1-17 ◆	Jog Frequency Reference Jog Reference	Speed command used when a jog is selected via multi-function input terminals. Setting units are affected by o1-03.	0.00 to E1-04 Value	6.00Hz	Programming

◆Denotes that parameter can be changed when the Drive is running.

Table A.1 Parameter List (Continued)

Parameter No.	Parameter Name Digital Operator Display	Description	Setting Range	Factory Setting	Menu Location
Reference Limits					
d2-01	Frequency Reference Upper Limit Ref Upper Limit	Determines maximum speed command, set as a percentage of parameter E1-04. If speed command is above this value, actual Drive speed will be limited to this value. This parameter applies to all speed command sources.	0.0 to 110.0	100.0%	Quick Setting
d2-02	Frequency Reference Lower Limit Ref Lower Limit	Determines minimum speed command, set as a percentage of parameter E1-04. If speed command is below this value, actual Drive speed will be set to this value. This parameter applies to all speed command sources.	0.0 to 110.0	0.0%	Quick Setting
d2-03	Master Speed Reference Lower Limit Ref1 Lower Limit	Determines the minimum speed command, set as a percentage of parameter E1-04. If speed command is below this value, actual Drive speed will be set to this value. This parameter only applies to analog inputs A1 and A2.	0.0 to 110.0	0.0%	Programming
Jump Frequencies					
d3-01	Jump Frequency 1 Jump Freq 1	These parameters allow programming of up to three prohibited frequency points for eliminating problems with resonant vibration of the motor / machine. This feature does not actually eliminate the selected frequency values, but will accelerate and decelerate the motor through the prohibited bandwidth.	0.0 to 200.0	0.0Hz	Programming
d3-02	Jump Frequency 2 Jump Freq 2			0.0Hz	Programming
d3-03	Jump Frequency 3 Jump Freq 3			0.0Hz	Programming
d3-04	Jump Frequency Width Jump Bandwidth	This parameter determines the width of the deadband around each selected prohibited frequency point. A setting of "1.0" will result in a deadband of +/- 1.0 Hz.	0.0 to 20.0	1.0Hz	Programming
Sequence					
d4-01	MOP Ref Memory	0: Disabled 1: Enabled	0 or 1	0	Programming
d4-02	Trim Control Level Trim Control Lvl	Set the percentage of maximum speed to be added or subtracted via multi-function inputs.	0 to 100	10%	Programming

Table A.1 Parameter List (Continued)

Parameter No.	Parameter Name Digital Operator Display	Description	Setting Range	Factory Setting	Menu Location	
			V/F Pattern			
E1-01	Input Voltage Setting Input Voltage	Set to the nominal voltage of the incoming line.	155 to 255.0 (240V) 310 to 510.0 (480V)	240V 480V	Quick Setting	
E1-03	V/F Pattern Selection V/F Selection	0: 50Hz 1: 60 Hz Saturation 2: 50 Hz Saturation 3: 72 Hz 4: 50 Hz VT1 5: 50 Hz VT2 6: 60 Hz VT1 7: 60 Hz VT2 8: 50 Hz HST1 9: 50 Hz HST2 A: 60 Hz HST1 B: 60 Hz HST2 C: 90 Hz D: 120 Hz F: Custom V/F FF: Custom w/o limit	0 to FF	F	Programming	
E1-04	Maximum Output Frequency Max Frequency	<p>Output voltage (V)</p> <p>VMAX (E1-05) VBASE (E1-13) VA (E1-08) VMIN (E1-10)</p> <p>FMIN (E1-09) FA (E1-07) FBASE (E1-06) FMAX (E1-04)</p> <p>Frequency (Hz)</p>	0.0 to 200.0	60.0Hz	Programming	
E1-05	Maximum Output Voltage Max Voltage		0 to 255.0 (240V) 0 to 510.0 (480V)	230.0V 460.0V	Programming	
E1-06	Base Frequency Base Frequency		0.0 to 200.0	60.0Hz	Programming	
E1-07	Mid Output Frequency A Mid Frequency A		0.0 to 200.0	3.0Hz	Programming	
E1-08	Mid Output Voltage A Mid Voltage A		0 to 255.0 (240V) 0 to 510.0 (480V)	18.0VAC	Programming	
E1-09	Minimum Output Frequency Min Frequency		0.0 to 200.0	1.5Hz	Programming	
E1-10	Mid Output Voltage Min Voltage		To set V/f characteristics in a straight line, set the same values for E1-07 and E1-09. In this case, the setting for E1-08 will be disregarded. Always ensure that the four frequencies are set in the following manner: E1-04 (FMAX) ≥ E1-06 (FA) > E1-07 (FB) ≥ E1-09 (FMIN)	0 to 255.0 (240V) 0 to 510.0 (480V)	10.8VAC	Programming
E1-11	Mid Output Frequency B Mid Frequency B		0.0 to 200.0	0.0Hz	Programming	
E1-12	Mid Output Voltage B Mid Voltage B		Set only when V/f is finely adjusted at rated output range. Adjustment is not normally required.	0 to 255.0 (240V) 0 to 510.0 (480V)	0.0VAC	Programming
E1-13	Base Voltage Base Voltage		0 to 255.0 (240V) 0 to 510.0 (480V)	0.0VAC	Programming	

Table A.1 Parameter List (Continued)

Parameter No.	Parameter Name Digital Operator Display	Description	Setting Range	Factory Setting	Menu Location
Motor Setup					
E2-01	Motor Rated Current Motor Rated FLA	Set to the motor nameplate full load amps.	10% to 200%	kVA Dependent	Quick Setting
E2-03	No-Load Current	Sets the magnetizing current of the motor.	kVA Dependent	kVA Dependent	Programming
E2-05	Motor Line-to-Line Resistance Term Resistance	Phase to phase motor resistance, normally set by the autotuning routine.	0.000 to 65.000	9.842Ω	Programming
Com OPT Setup					
F6-01	Operation Selection after Communication Error Com Bus Flt Sel	Sets the stopping method for option PCB communications error (BUS fault). Active only when a communications option PCB is installed and when b1-01 or b1-02 = 3. 0: Ramp to Stop 1: Coast to Stop 2: Fast-Stop 3: Alarm Only	0 to 3	1	Programming
F6-02	Input Level of External Fault from Communication Option Card EFO Detection	0: Always detected 1: Detected only during run	0 or 1	0	Programming
F6-03	Stopping Method for External Fault from Communication Option Card EFO Fault Action	0: Ramp to Stop 1: Coast to Stop 2: Fast-Stop 3: Alarm Only	0 to 3	1	Programming
F6-05	Current Monitor Display Unit Selection Current Unit Sel	0: A Display 1: 100%/8192 (Drive Rated Current)	0 or 1	0	Programming

Table A.1 Parameter List (Continued)

Parameter No.	Parameter Name Digital Operator Display	Description	Setting Range	Factory Setting	Menu Location
Digital Inputs					
H1-01	Terminal S3 Function Selection Terminal S3 Sel	<p>0: 3-wire control FWD/REV selection for 3-wire sequence</p> <p>1: Local/Remote Sel Hand/Auto Selection - Closed = Hand, Open = Auto</p> <p>2: Option/Inv Sel Selects source of speed command and sequence Closed = b1-01 & b1-02, Open = Option Card</p> <p>3: Multi-Step Ref 1 Closed = speed command from d1-02 or Aux Terminal Open = speed command determined by b1-01</p> <p>4: Multi-Step Ref 2 Closed = speed command from d1-03 or d1-04 Open speed command determined by b1-01</p> <p>6: Jog Freq Ref Closed = speed command from d1-17 Open = speed command determined by b1-01</p> <p>7: Multi-Acc/Dec 1 Closed = Accel & Decel Ramps determined by C1-03 & C1-04 Open = Accel & Decel Ramps determined by C1-01 & C1-02</p> <p>8: Ext BaseBlk N.O. Closed = Output transistors forced off, Open = Normal operation</p> <p>9: Ext BaseBlk N.C. Closed = Normal Operation, Open = Output transistors forced off</p> <p>A: Acc/Dec RampHold Closed = Acceleration suspended and speed held, Open = Normal Operation</p> <p>C: Term A2 Enable Closed = Terminal A2 is active, Open = Terminal A2 is disabled</p> <p>F: Term Not Used Terminal has no effect</p> <p>10: MOP Increase Closed = Speed Command Increases, Open = Speed Command Held. Must be set in conjunction with MOP Decrease and b1-02 must be set to 1.</p> <p>11: MOP Decrease Closed = Speed Command Decreases, Open = Speed Command Held. Must be set in conjunction with MOP Increase and b1-02 must be set to 1.</p> <p style="text-align: center;">(Continued on next page)</p>	0 to 6E	24	Programming
H1-02	Terminal S4 Function Selection Terminal S4 Sel	<p>10: MOP Increase Closed = Speed Command Increases, Open = Speed Command Held. Must be set in conjunction with MOP Decrease and b1-02 must be set to 1.</p> <p>11: MOP Decrease Closed = Speed Command Decreases, Open = Speed Command Held. Must be set in conjunction with MOP Increase and b1-02 must be set to 1.</p> <p style="text-align: center;">(Continued on next page)</p>	0 to 6E	14	Programming

Table A.1 Parameter List (Continued)

Parameter No.	Parameter Name Digital Operator Display	Description	Setting Range	Factory Setting	Menu Location
H1-03	Terminal S5 Function Selection Terminal S5 Sel	<p>12: Forward Jog Closed = Drive runs forward at speed command entered into parameter d1-17.</p> <p>13: Reverse Jog Closed = Drive runs in reverse at speed command entered into parameter d1-17.</p> <p>14: Fault Reset Closed = Resets the Drive after the fault and the run command have been removed.</p> <p>15: Fast-Stop N.O. Closed = Drive decelerates using C1-09, regardless of run command status.</p> <p>17: Fast-Stop N.C. Closed = Normal operation Open = Drive decelerates using C1-09, regardless of run command status.</p> <p>18: Timer Function Input for independent timer, controlled by b4-01 and b4-02. Used in conjunction with a multi-function digital output.</p> <p>19: PI Disable Turns off the PI controller, and PI setpoint becomes speed command.</p> <p>1B: Program Lockout Closed = All parameter settings can be changed. Open = Only speed command at U1-01 can be changed.</p> <p>1C: TrimCtl Increase Closed = Increase motor speed by value in d4-02. Open = Return to normal speed command. Not effective when using d1-01 thru d1-04 as a speed command. Must be used in conjunction with Trim Ctrl Decrease.</p> <p>1D: Trim Ctl Decrease Closed = Decrease motor speed by value in d4-02. Open = Return to normal speed command. Not effective when using d1-01 thru d1-04 as speed command. Must be used in conjunction with Trim Ctrl Increase.</p>	0 to 6E	3: 2-wire 0: 3-wire	Programming

Table A.1 Parameter List (Continued)

Parameter No.	Parameter Name Digital Operator Display	Description	Setting Range	Factory Setting	Menu Location
Digital Inputs					
H1-04	Terminal S6 Function Selection Terminal S6 Sel	<p>1E: Ref Sample Hold Analog speed command is sampled then held at time of input closure.</p> <p>20: External fault, Normally Open, Always Detected, Ramp To Stop</p> <p>21: External fault, Normally Closed, Always Detected, Ramp To Stop</p> <p>22: External fault, Normally Open, During Run, Ramp To Stop</p> <p>23: External fault, Normally Closed, During Run, Ramp To Stop</p> <p>24: External fault, Normally Open, Always Detected, Coast To Stop</p> <p>25: External fault, Normally Closed, Always Detected, Coast To Stop</p> <p>26: External fault, Normally Open, During Run, Coast To Stop</p> <p>27: External fault, Normally Closed, During Run, Coast To Stop</p> <p>28: External fault, Normally Open, Always Detected, Fast-Stop</p> <p>29: External fault, Normally Open, Always Detected, Fast-Stop</p> <p>2A: External fault, Normally Open, During Run, Fast-Stop</p> <p>2B: External fault, Normally Closed, During Run, Fast-Stop</p> <p>2C: External fault, Normally Open, Always Detected, Alarm Only</p> <p>2D: External fault, Normally Closed, Always Detected, Alarm Only</p> <p>2E: External fault, Normally Open, During Run, Alarm Only</p> <p>2F: External fault, Normally Closed, During Run, Alarm Only</p> <p>34: PI SFS Cancel</p> <p>36: Option/Inv Sel 2 Selects source of speed command and sequence Closed = Option Card, Open = b1-01 & b1-02</p> <p>60: Motor Preheat Applies current to create heat to avoid condensation. Closed = Apply amount of current as set in parameter b2-09</p> <p>61: Speed Search 1 When closed as a run command is given, Drive does a speed search starting at maximum frequency (E1-04). (Current detection)</p>	0 to 6E	4: 2-wire 3: 3-wire	Programming
H1-05	Terminal S7 Function Selection Terminal S7 Sel	<p>62: Speed Search 2 When closed as a run command is given, Drive does a speed search starting at speed command. (Current detection).</p> <p>64: Speed Search 3</p> <p>67: Com Test Mode - Used to test RS-485/422 interface.</p> <p>68: High Slip Braking - Closed = Drive stops using High Slip Braking regardless of run command status.</p> <p>69: Jog2 - Closed = Drive runs at speed command entered into parameter d1-17. Direction determined by fwd/rev input. 3-wire control Only.</p> <p>6A: Drive Enable - Closed = Drive will accept run command. Open = Drive will not run. If running, Drive will stop per b1-03.</p> <p>6B: Com/Inv Sel - Selects source of speed command and sequence Closed = Serial Communication (R+,R-,S+,S-), Open = b1-01 & b1-02</p> <p>6C: Com/Inv Sel 2</p> <p>6D: Auto Mode Sel - Hand/Auto Selection - Closed = Auto, Open = Hand</p> <p>6E: Hand Mode Sel - Hand/Auto Selection - Closed = Hand, Open = Auto</p> <p>70: Bypass/Drv Enbl</p> <p>80: Motor Preheat 2 - Closed = Enable motor preheat with the current level as set by b2-10</p> <p>81: EmergOverrideFWD - Closed = Forward Emergency Override Command</p> <p>82: EmergOverrideREV - Closed = Reverse Emergency Override Command</p>	0 to 6E	6: 2-wire 4: 3-wire	Programming

Table A.1 E7 User Parameter List (Continued)

Parameter No.	Parameter Name Digital Operator Display	Description	Setting Range	Factory Setting	Menu Location
Digital Outputs					
H2-01	Terminal M1-M2 Function Selection Term M1-M2 Sel	<p>0: During RUN 1 = Closed when a run command is input or the Drive is outputting voltage.</p> <p>1: Zero Speed = Closed when Drive output frequency is less than Fmin (E1-09)</p> <p>2: Fref/Fout Agree 1 = Closed when Drive output speed equals the speed command within the bandwidth of L4-02.</p> <p>3: Fref/Set Agree 1 = Closed when the Drive output speed and the speed command are equal to the value in L4-01 within the bandwidth of L4-02.</p> <p>4: Freq Detect 1 = Closed when the Drive output speed is less than or equal to the value in L4-01, with hysteresis determined by L4-02.</p> <p>5: Freq Detect 2 = Closed when the Drive output speed is greater than or equal to the value in L4-01, with hysteresis determined by L4-02.</p> <p>6: Inverter Ready = Closed when the Drive is not in a fault state, and not in program mode.</p> <p>7: DC Bus Undervolt = Closed when the DC bus voltage falls below the UV trip level (L2-05)</p> <p>8: Base Blk 1 = Closed when the Drive is not outputting voltage.</p> <p>9: Operator Reference = Closed when the speed command is coming from the digital operator.</p> <p>A: Remote/Auto Oper = Closed when the run command is coming from the digital operator.</p> <p>B: Trq Det 1 N.O. - Closes when the output current exceeds the value set in parameter L6-02 for more time than is set in parameter L6-03.</p>	0 to 3B	0	Programming
H2-02	Terminal M3-M4 Function Selection Term M3-M4 Sel	<p>C: Loss of Ref - Closes when the Drive has detected a loss of analog speed command. Speed command is considered lost when it drops 90% in 0.4 seconds. Parameter L4-05 determines Drive reaction to a loss of speed command.</p> <p>D: DB Overheat</p> <p>E: Fault - Closes when the Drive experiences a major fault.</p> <p>F: Not Used</p> <p>10: Minor Fault - Closes when Drive experiences a minor fault or alarm.</p> <p>11: Reset Cmd Active - Closes when the Drive receives a reset command from terminals or serial comms.</p> <p>12: Timer Output - Output for independent timer, controlled by b4-01 and b4-02. Used in conjunction with a multi-function digital input.</p> <p>17: Trq. Det 1 N.C. - Opens when the output current exceeds the value set in parameter L6-02 for more time than is set in parameter L6-03.</p> <p>1A: Reverse Dir - Closes when the Drive is running in the reverse direction.</p> <p>1E: Restart Enabled - Closes when the Drive is performing an automatic restart. Automatic restart is configured by parameter L5-01.</p> <p>1F: Overload (OL1) - Closes before a motor overload occurs. (90% of OL1 time)</p> <p>20: OH Prealarm - Closes when the Drive's heatsink temperature exceeds the setting of parameter L8-02.</p> <p>38: Drive Enable - Closes when the Drive enable input is active.</p> <p>39: Waiting to Run - Closes during the time after a run command is issued, but the Drive is not running due to the time set in parameter b1-10.</p> <p>3A: OH Freq Reduce</p> <p>3B: Run Src Com/Opt</p> <p>3D: Cooling Fan Err = Closed during internal cooling fan failure</p>	0 to 3B	A	Programming

Table A.1 Parameter List (Continued)

Parameter No.	Parameter Name Digital Operator Display	Description	Setting Range	Factory Setting	Menu Location
Analog Inputs					
H3-02 ◆	Terminal A1 Gain Setting Terminal A1 Gain	Sets the speed command when 10V is input, as a percentage of the maximum output frequency (E1-04).	0.0 to 1000.0	100.0%	Programming
H3-03 ◆	Terminal A1 Bias Setting Terminal A1 Bias	Sets the speed command when 0V is input, as a percentage of the maximum output frequency (E1-04).	-100.0 to +100.0	0.0%	Programming
H3-08	Terminal A2 Signal Level Selection Term A2 Signal	Selects the signal level of terminal A2. 0: 0 - 10VDC (switch S1-2 must be in the off position) 2: 4 - 20 mA (switch S1-2 must be in the on position)	0 or 2	2	Programming*
H3-09	Aux Terminal Function Selection Terminal A2 Sel	Selects what effect the aux terminal has on the Drive. 0: Frequency Bias - 0 - 100% bias 2: Aux Reference B: PI Feedback D: Frequency Bias 2 - 0 - 100% bias E: Motor Temperature - See parameters L1-03 & L1-04 16: PI Differential 1F: Not Used	0 to 1F	2**	Programming*
H3-10 ◆	Terminal A2 Gain Setting Terminal A2 Gain	Sets the percentage when 10V (20mA) is input.	0.0 to 1000.0	100.0%	Programming
H3-11 ◆	Terminal A2 Bias Setting Terminal A2 Bias	Sets the percentage when 0V (4mA) is input.	-100.0 to +100.0	0.0%	Programming
H3-12	Analog Input Filter Time Constant Filter Avg Time	Used to "smooth" out erratic or noisy analog input signals.	0.00 to 2.00	0.30sec	Programming
H3-13	Master Frequency Reference Terminal Selection TA1/A2 Select	Determines which terminal will be the main reference source. 0: Main Fref TA1 - Terminal TA1 is the main speed command and Terminal TA2 is the Aux speed command. 1: Main Fref TA2 - Terminal TA2 is the main speed command and Terminal TA1 is the Aux speed command. Only effective when H3-09 is set to 2 "Aux Reference".	0 or 1	0	Programming*
◆ Denotes that parameter can be changed when the drive is running. * Menu location is Quick Setting when b5-01=1, and Programming when b5-01=0. ** Factory setting changes to "B" when b5-01=1.					

Table A.1 Parameter List (Continued)

Parameter No.	Parameter Name Digital Operator Display	Description	Setting Range	Factory Setting	Menu Location
Analog Outputs					
H4-01	Terminal FM Monitor Selection Terminal FM Sel	Selects which monitor will be output on terminals FM and AC. 1: Frequency Ref (100% = max. output frequency) 2: Output Freq (100% = max. output frequency) 3: Output Current (100% = Drive rated current) 6: Output Voltage (100% = 230V or 100% = 460V) 7: DC Bus Voltage (100% = 400V or 100% = 800V) 8: Output kWatts (100% = Drive rated power) 15: Term A1 Level 16: Term A2 Level 18: Mot SEC Current (100% = Motor rated secondary current) 20: SFS Output (100% = max. output frequency) 24: PI Feedback 31: Not Used 36: PI Input 37: PI Output (100% = max. output frequency) 38: PI Setpoint 51: Auto Mode Fref (100% = max. output frequency) 52: Hand Mode Fref (100% = max. output frequency) 53: PI Feedback 2 NOTE: 100% = 10V DC output * FM gain setting (H4-02).	1 to 53	2	Programming
H4-02 ◆	Terminal FM Gain Setting Terminal FM Gain	Sets terminal FM output voltage (in percent of 10V) when selected monitor is at 100% output.	0.0 to 1000.0	100.0%	Programming
H4-03 ◆	Terminal FM Bias Setting Terminal FM Bias	Sets terminal FM output voltage (in percent of 10V) when selected monitor is at 0% output.	-110.0 to 110.0	0.0%	Programming
H4-04	Terminal AM Monitor Selection Terminal AM Sel	Selects which monitor will be output on terminals AM and AC. 1: Frequency Ref (100% = max. output frequency) 2: Output Freq (100% = max. output frequency) 3: Output Current (100% = Drive rated current) 6: Output Voltage (100% = 230V or 100% = 460V) 7: DC Bus Voltage (100% = 400V or 100% = 800V) 8: Output kWatts (100% = Drive rated power) 15: Term A1 Level 16: Term A2 Level 18: Mot SEC Current (100% = Motor rated secondary current) 20: SFS Output (100% = max. output frequency) 24: PI Feedback 31: Not Used 36: PI Input 37: PI Output (100% = max. output frequency) 38: PI Setpoint 51: Auto Mode Fref (100% = max. output frequency) 52: Hand Mode Fref (100% = max. output frequency) 53: PI Feedback 2 NOTE: 100% = 10V DC output * AM gain setting (H4-05).	1 to 53	8	Programming
H4-05 ◆	Terminal AM Gain Setting Terminal AM Gain	Sets terminal AM output voltage (in percent of 10V) when selected monitor is at 100% output.	0.0 to 1000.0	50.0%	Programming
◆Denotes that parameter can be changed when the Drive is running.					

Table A.1 Parameter List (Continued)

Parameter No.	Parameter Name Digital Operator Display	Description	Setting Range	Factory Setting	Menu Location
Analog Outputs					
H4-06 ◆	Terminal AM Bias Setting Terminal AM Bias	Sets terminal AM output voltage (in percent of 10V) when selected monitor is at 0% output.	-110.0 to 110.0	0.0%	Programming
H4-07	Terminal FM Signal Level Selection AO Level Select1	0: 0 - 10 VDC 2: 4-20 mA*	0 or 2	0	Programming
H4-08	Terminal AM Signal Level Selection AO Level Select2	0: 0 - 10 VDC 2: 4-20 mA* * An analog output of 4 - 20 mA can not be used with the standard terminal board. Therefore an optional terminal board (with shunt connector CN15) is needed.	0 or 2	0	Programming
Serial Com Setup					
H5-01	Drive Node Address Serial Com Adr	Selects Drive station node number (address) for terminals R+, R-, S+, S-.* Note: An address of "0" disables serial com.	0 to 20 (H5-08=0) 0 to FF (H5-08=1) 0 to 63 (H5-08=2)	1F	Programming
H5-02	Communication Speed Selection Serial Baud Rate	Selects the baud rate for terminals R+, R-, S+ and S-.* 0: 1200 Baud 1: 2400 Baud 2: 4800 Baud (APOGEE FLN) 3: 9600 Baud (Metasys N2) 4: 19200 Baud	0 to 4	3	Programming
H5-03	Communication Parity Selection Serial Com Sel	Selects the communication parity for terminals R+, R-, S+ and S-.* 0: No Parity 1: Even Parity 2: Odd Parity	0 to 2	0	Programming
H5-04	Stopping Method after Communication Error Serial Fault Sel	Selects the stopping method when a communication error is detected. 0: Ramp to Stop 1: Coast to Stop 2: Fast-Stop 3: Alarm Only 4: Runn at D1-04	0 to 3	3	Programming
H5-05	Communication Error Detection Selection Serial Flt Dtct	Enables or disables the communications timeout detection function. 0: Disabled - A communications loss will NOT cause a communications fault. 1: Enabled - If communications are lost for more than the time specified in parameter H5-09, a communications fault will occur.	0 or 1	1	Programming
H5-06	Drive Transmit Wait Time Transmit WaitTIM	Sets the time from when the Drive receives data to when the Drive sends data.	5 to 65	5ms	Programming
H5-07	RTS Control Selection RTS Control Sel	Enables or disables "request to send" (RTS) control: 0: Disabled (RTS is always on) 1: Enabled (RTS turns on only when sending)	0 or 1	1	Programming
H5-08	Communication Protocol Selection Protocol Select	Selects the communication protocol. 0: Memobus (Modbus) 1: N2 (Metasys) 2: FLN (APOGEE)	0 to 2	0	Programming
H5-09	Communication Error Detection Time CE Detect Time	Determines how long communications must be lost before a fault is annunciated. Works in conjunction with parameters H5-05 and H5-04.	0 to 10.0 (H5-08=0) 0 to 10.0 (H5-08=1) 0 to 90.0 (H5-08=2)	2.0sec	Programming
◆Denotes that parameter can be changed when the Drive is running. * After these parameters are changed, Drive power must be cycled before the changes will take effect.					

Table A.1 Parameter List (Continued)

Parameter No.	Parameter Name Digital Operator Display	Description	Setting Range	Factory Setting	Menu Location
		Motor Overload			
L1-01	Motor Overload Protection Selection MOL Fault Select	Enables or disables the motor thermal overload protection. 0: Disabled 1: Std Fan Cooled (Enabled) 2: Std Blower Cooled 3: Vector Motor	0 to 1	1	Programming
L1-02	Motor Overload Protection Time MOL Time Const	Determines how much time will elapse prior to a motor overload fault (OL1), when motor amps exceed the value set in parameter E2-01 by 10%. Actual (OL1) trip time will vary depending on severity of overload.	0.1 to 20.0	8.0min	Programming
L1-03	Motor Overheat Alarm Operation Selection Mtr OH Alarm Sel	Operation selection when the motor temperature analog input (H3-09=E) exceeds the OH3 alarm level (1.17V) 0: Ramp to Stop 1: Coast to Stop 2: Fast-Stop 3: Alarm Only	0 to 3	3	Programming
L1-04	Motor Overheat Fault Operation Selection Mtr OH Fault Sel	Stopping method when the motor temperature analog input (H3-09=E) exceeds the OH4 level (2.34V). 0: Ramp to Stop 1: Coast to Stop 2: Fast-Stop	0 to 2	1	Programming
L1-05	Motor Temperature Input Filter Time Mtr Temp Filter	Delay Time applied to motor temperature analog input (H3-09=E) for filtering purposes.	0.00 to 10.00	0.20sec	Programming
		PwrLoss Ridethru			
L2-01	Momentary Power Loss Detection Selection PwrL Selection	Enables and disables the momentary power loss function. 0: Disabled - Drive trips on (UV1) fault when power is lost. 1: PwrL Ride Thru t - Drive will restart if power returns within the time set in L2-02.* 2: CPU Power Active - Drive will restart if power returns prior to internal power supply shut down.* * In order for a restart to occur, the run command must be maintained throughout the ride thru period.	0 to 2	2	Programming
L2-02	Momentary Power Loss Ride-thru Time PwrL Ridethru t	Determines the power loss ride-thru time. This value is dependent on the capacity of the Drive. Only effective when L2-01 = 1.	0.0 to 25.5sec	kVA Dependent	Programming
L2-03	Momentary Power Loss Minimum Base Block Time PwrL Baseblock t	Used to allow the residual motor voltage to decay before the Drive output turns back on. After a power loss, if L2-03 is greater than L2-02, operation resumes after the time set in L2-03.	0.1 to 5.0sec	kVA Dependent	Programming
L2-04	Momentary Power Loss Voltage Recovery Ramp Time PwrL V/F Ramp t	The time it takes the output voltage to return to the preset V/f pattern after speed search (current detection mode) is complete.	0.0 to 5.0sec	kVA Dependent	Programming
L2-05	Undervoltage Detection Level PUV Det Level	Sets the Drive's DC Bus undervoltage trip level. If this is set lower than the factory setting, additional AC input reactance or DC bus reactance may be necessary.	Voltage Class Dependent	Voltage Class Dependent	Programming

Table A.1 Parameter List (Continued)

Parameter No.	Parameter Name Digital Operator Display	Description	Setting Range	Factory Setting	Menu Location
Stall Prevention					
L3-01	Stall Prevention Selection During Accel StallP Accel Sel	<p>0: Disabled (Motor accelerates at active acceleration, C1-01 or C1-03. The motor may stall if load is too heavy or accel time is too short.)</p> <p>1: General Purpose (When output current exceeds L3-02 level, acceleration stops. It starts to accelerate at current value recovery.)</p> <p>2: Intelligent (The active acceleration rate, C1-01 or C1-02, is ignored. Acceleration is completed in the shortest amount of time w/o exceeding the current value set in L3-02.)</p>	0 to 2	1	Programming
L3-02	Stall Prevention Level During Accel StallP Accel Lvl	This function is enabled when L3-01 is "1" or "2". Drive rated current is 100%. Decrease the set value if stalling occurs at factory setting.	0 to 200	120%	Programming
L3-04	Stall Prevention Selection During Decel StallP Decel Sel	<p>0: Disabled (The Drive decelerates at the active deceleration rate, C1-02 or C1-04. If the load is too large or the deceleration time is too short, an OV fault may occur.)</p> <p>1: General Purpose (The Drive decelerates at the active deceleration rate, C1-02 or C1-04, but if the main circuit DC bus voltage reaches the stall prevention level the output frequency will clamp. Deceleration will continue once the DC bus level drops below the stall prevention level.)</p> <p>2: Intelligent (The active deceleration rate is ignored and the Drive decelerates as fast as possible w/o hitting OV fault level.)</p>	0 to 3	1	Programming
L3-05	Stall Prevention Level During Decel StallP Run Sel	<p>0: Disabled (Drive runs a set frequency.) A heavy load may cause the Drive to trip on an OC fault.</p> <p>1: Decel Time 1 (In order to avoid stalling during heavy loading, the Drive will start to decelerate at Decel time 1 (C1-02) if the output current exceeds the level set by L3-06. Once the current level drops below the L3-06 level the Drive will accelerate back to its set frequency at the active acceleration rate.)</p> <p>2: Decel Time 2 (Same as setting 1 except the Drive decelerates at Decel Time 2 (C1-04).)</p> <p>For 6Hz or less frequency, stall prevention function during run is disabled regardless of L3-05 set.</p>	0 to 2	1	Programming
L3-06	Stall Prevention Level During Running StallP Run Level	This function is enabled when L3-05 is "1" or "2". Drive rated current is set as 100%. Normally, changing the setting is not required. Decrease the set value if stalling occurs at factory setting.	30 to 200	120%	Programming

Table A.1 Parameter List (Continued)

Parameter No.	Parameter Name Digital Operator Display	Description	Setting Range	Factory Setting	Menu Location
Ref Detection					
L4-01	Speed Agreement Detection Level Spd Agree Level	L4-01 and L4-02 are used in conjunction with the multi-function outputs, (H2-01 and H2-02) as a setpoint and hysteresis for a contact closure.	0.0 to 200.0	0.0Hz	Programming
L4-02	Speed Agreement Detection Width Spd Agree Width		0.0 to 20.0	2.0Hz	Programming
L4-05	Frequency Reference Loss Detection Selection Ref Loss Sel	Determines how the Drive will react when the frequency reference is lost. 0: Stop (Disabled) - Drive will not run at the frequency reference 1: Enabled @ % of PrevRef - Drive will run at a percentage (L4-06) of the frequency reference level at the time frequency reference was lost.	0 or 1	1	Programming
L4-06	Frequency Reference Level at Loss Frequency Fref at Floss	If Frequency Reference loss function is enabled (L4-05=1) and Frequency Reference is lost, then the Drive will run at reduced frequency reference determined by L4-06. New Fref=Fref at time of loss x L4-06.	0 to 100.0%	80.0%	Programming
Fault Restart					
L5-01	Number of Auto Restart Attempts Num of Restarts	Determines the number of times the Drive will perform an automatic restart.	0 to 10	0	Quick Setting
L5-02	Auto Restart Operation Selection Restart Sel	Determines if the fault contact activates during an automatic restart attempt. 0: No Flt Relay - fault contact will not activate during an automatic restart. 1: Flt Relay Active - fault contact will activate during an automatic restart.	0 or 1	0	Programming
L5-03	Maximum Restart Time After Fault Max Restart Time	If the restart fails (or is not attempted due to a continuing fault condition, e.g. an OV fault) the Drive waits L5-03 seconds before attempting another restart.	0.5 to 600.0	180.0sec	Quick Setting
Torque Detection					
L6-01	Torque Detection Selection 1 Load Detection	Determines the Drive's response to an overtorque / undertorque condition. Overtorque and Undertorque are determined by the settings in parameters L6-02 and L6-03. 0: Disabled 1: OL@SpdAgree - Alm (Overtorque Detection only active during Speed Agree and Operation continues after detection) 2: OL At RUN - Alm (Overtorque Detection is always active and operation continues after detection) 3: OL@SpdAgree - Flt (Overtorque Detection only active during Speed Agree and Drive output will shut down on an OL3 fault.) 4: OL At RUN - Flt (Overtorque Detection is always active and Drive output will shut down on an OL3 fault.) 5: LL@SpdAgree - Alm (Undertorque Detection is only active during Speed Agree and operation continues after detection.) 6: LL at RUN - Alm (Undertorque Detection is always active and operation continues after detection.) 7: LL @ SpdAgree - Flt (Undertorque Detection only active during Speed Agree and Drive output will shut down on an OL3 fault.) 8: LL At RUN - Flt (Undertorque Detection is always active and Drive output will shut down on an OL3 fault.)	0 to 8	0	Programming
L6-02	Torque Detection Level 1 Load Det Lvl	Sets the overtorque/undertorque detection level as a percentage of Drive rated current.	0 to 300	15%	Programming
L6-03	Torque Detection Time 1 Loss Det Time	Sets the length of time an overtorque / undertorque condition must exist before being recognized by the Drive. OL3 is then displayed.	0.0 to 10.0	10.0sec	Programming

Table A.1 Parameter List (Continued)

Parameter No.	Parameter Name Digital Operator Display	Description	Setting Range	Factory Setting	Menu Location
Hdwe Protection					
L8-01	Internal Dynamic Braking Resistor Protection Selection DB Resistor Prot	0: Not Provided 1: Provided	0 or 1	0	Programming
L8-02	Overheat Pre-Alarm Level OH Pre-Alarm Lvl	When the cooling fin temperature exceeds the value set in this parameter, an overheat pre-alarm (OH) will occur.	50 to 130	95°C	Programming
L8-03	Overheat Pre-Alarm Operation Selection OH Pre-Alarm Sel	Drive Operation upon OH Pre Alarm Detection. 0: Ramp to Stop (Decel Time C1-02). 1: Coast to Stop 2: Fast-Stop (Decel Time = C1-09). 3: Alarm Only *0 to 2 is recognized as fault detection, and 3 is recognized as alarm. (For the fault detection, the fault contact operates.) 4: OH Alarm & Reduce (Continue operation and reduce output frequency by L8-19)	0 to 4	4	Programming
L8-06	Input Phase Loss Detection Level Ph Loss In Lvl	Monitors the DC Bus current ripple and activates when one of the input phases is lost (PF).	0.0 to 25.0	5.0%	Programming
L8-09	Output Ground Fault Detection Selection Ground Fault Sel	Enables and disables Drive output ground fault detection. 0: Disabled 1: Enabled	0 or 1	1	Programming
L8-10	Heatsink Cooling Fan Operation Selection Fan On/Off Sel	Controls the Heatsink Cooling Fan Operation. 0: Fan On-Run Mode (Fan will operate only when Drive is running and for L8-11 seconds after RUN is removed). 1: Fan Always On (Cooling fan operates whenever Drive is powered up.)	0 or 1	0	Programming
L8-11	Heatsink Cooling Fan Operation Delay Time Fan Delay Time	When L8-10=0 this parameter sets a delay time for Cooling Fan de-energization after the run command is removed.	0 to 300	300sec	Programming
L8-12	Ambient Temperature Setting Ambient Temp	When the Drive is installed in an ambient temperature exceeding its rating, Drive overload (OL2) protection level is reduced.	45 to 60°C	45°C	Programming
L8-15	OL2 Characteristic Selection at Low Speeds OL2 Sel @ L-Spd	This parameter assists in protecting the output transistor junctions from overheating when output current is high and output frequency is low. 0: Disabled 1: Enabled (L8-18 is active)	0 or 1	1	Programming
L8-18	Soft CLA Selection Soft CLA Sel	Enables and disables current limit "A" 0: Disabled 1: Enabled.	0 or 1	1	Programming
L8-19	OH Frequency Reference Reduction Level Fref During OH	Sets the amount of frequency reference reduction when an Overheat Pre-alarm (OH) is detected.	0.0 to 100.0	20.0%	Programming
L8-32	OH1 Detection Selection for Fan Failure OH1 Detect Sel	Selects the drive response upon failure of the internal cooling fan. 0: Disabled FAN alarm is displayed 1: Enabled OH1 fault occurs	0 or 1	1	Programming

Table A.1 Parameter List (Continued)

Parameter No.	Parameter Name Digital Operator Display	Description	Setting Range	Factory Setting	Menu Location								
Hunting Prev													
n1-01	Hunting Prevention Selection Hunt Prev Select	0: Disabled (Hunting prevention function disabled.) 1: Enabled (Hunting prevention function enabled.) If the motor vibrates while lightly loaded, hunting prevention may reduce the vibration. There is a loss of responsiveness if hunting prevention is enabled.	0 or 1	1	Programming								
n1-02	Hunting Prevention Gain Setting Hunt Prev Gain	Gain setting for the Hunting Prevention Function. If the motor vibrates while lightly loaded and n1-01=1, increase the gain by 0.1 until vibration ceases. If the motor stalls while n1-01=1 decrease the gain by 0.1 until the stalling ceases.	0.00 to 2.50	1.00	Programming								
HighSlip													
n3-01	High-Slip Braking Deceleration Frequency Width HSB Decel Width	Sets how aggressively the Drive decreases the output frequency as it stops the motor. If overvoltage (OV) faults occur during HSB, this parameter may need to be increased.	1 to 20	5%	Programming								
n3-02	High-Slip Braking Current Limit HSB Current Ref	Sets the maximum current to be drawn during a HSB stop. Higher n3-02 settings will shorten motor stopping times but cause increased motor current, and therefore increased motor heating.	100 to 200	150%	Programming								
n3-03	High-Slip Braking Dwell Time at Stop HSB DwellTim@ Stp	Sets the amount of time the Drive will dwell at E1-09 (Minimum Frequency). If this time is set too low, the machine inertia can cause the motor to rotate slightly after the HSB stop is complete and the Drive output is shut off.	0.0 to 10.0	1.0sec	Programming								
n3-04	High-Slip Braking Overload Time HSB OL Time	Sets the time required for a HSB Overload Fault to occur when the Drive output frequency does not change for some reason during a HSB stop. Normally this does not need to be adjusted.	30 to 1200	40sec	Programming								
Monitor Select													
o1-01 ◆	User Monitor Selection User Monitor Sel	Selects which monitor will be displayed upon power-up when o1-02 = 4.	6 to 53	6	Programming								
o1-02	User Monitor Selection After Power-Up Power-On Monitor	Selects which monitor will be displayed upon power-up. 1: Frequency Ref 2: Output Freq 3: Output Current 4: User Monitor (set by o1-01)	1 to 4	1**	Programming								
o1-03	Digital Operator Display Selection Display Scaling	Sets the units of the Frequency References (d1-01 through d1-17) and the Frequency Reference Monitor (U1-01). 0: Hz 1: % (100% = E1-04) 2 to 39: RPM. (Enter the number of motor poles.) 40 to 39999: User display Desired set/display value is set at Max.  □□□□ output frequency. 4 digit number. The number of digits from the right the decimal point is displayed. Example: If "200.0 is displayed at Max. output frequency, set "12000". When o1-03≥40 (user units), the unit selected in o1-09 will be displayed for D1-01 to D1-17, U1-01, U1-02, and U1-20	0 to 39999	0	Programming								
o1-05	LCD Brightness Adjustment LCD Contrast	<table border="1" data-bbox="633 1627 1015 1837"> <thead> <tr> <th>Set Value</th> <th>Description</th> </tr> </thead> <tbody> <tr> <td>5</td> <td>LCD display becomes dark</td> </tr> <tr> <td>3</td> <td>Standard setting</td> </tr> <tr> <td>1</td> <td>LCD display becomes light</td> </tr> </tbody> </table>	Set Value	Description	5	LCD display becomes dark	3	Standard setting	1	LCD display becomes light	0 to 5	3	Programming
Set Value	Description												
5	LCD display becomes dark												
3	Standard setting												
1	LCD display becomes light												

** Factory setting changes to "2" when b5-01=1

Table A.1 Parameter List (Continued)

Parameter No.	Parameter Name Digital Operator Display	Description	Setting Range	Factory Setting	Menu Location
o1-06	User Monitor Selection Mode Monitor Mode Sel	Selects the "U1" monitors displayed on the 4th and 5th lines of the digital operator display. 0: 3 Mon Sequential (Displays the next 2 sequential U1 monitors.) 1: 3 Mon Selectable (Displays U1 monitors set by o1-07 and o1-08.)	0 or 1	0**	Programming
o1-07	Second Line User Monitor Selection 2nd Monitor Sel	Sets the "U1" monitor always displayed on the 4th line of the digital operator display. Effective only when o1-06 = 1.	1 to 53	2**	Programming
o1-08	Third Line User Monitor Selection 3rd Monitor Sel	Sets the "U1" monitor always displayed on the 5th line of the digital operator display. Effective only when o1-06 = 1.	1 to 53	3**	Programming
o1-09 ◆	Frequency Reference Display Units Frq Display Unit	Sets unit display for the frequency reference parameters and frequency related monitors when o1-03≥40. 0: WC:InchOfWater 1: PSI:lb/SqrInch 2: GPM:Gallons/Min 3: F:DegFahrenheit 4: CFM:Cubic ft/Min 5: CMH:Cubic M/Hr 6: LPH:Liters/Hr 7: LPS:Liters/Sec 8: Bar:Bar 9: Pa:Pascals 10: C:DegCelsius 11: Mtr:Meters	0 to 11	0	Programming
Key Selections					
o2-01	Local/Remote Key Function Selection Local/Remote Key	Has no function when HOA operator (Part# JVOP-162) is connected.			
o2-02	OFF Key Function During Auto Run Oper OFF Key	Determines if the off key on the digital operator will stop the Drive when Drive is operating from external terminals or serial communications. 0: Disabled 1: Enabled	0 or 1	1	Programming
o2-03	User Parameter Default Value User Defaults	Allows storing of current parameter values as a User Initialization Selection at parameter A1-03. 0: No Change (No user parameter set active). 1: Set Defaults (Saves current parameter settings as user initialization. A1-03 now allows selecting <1110> for user initialization. 2: Clear All (Clears the currently saved user initialization. A1-03 no longer allows selecting <1110>).	0 to 2	0	Programming
o2-04	Drive/kVA Selection Inverter Model #	Sets the kVA of the Drive. Enter the number based on Drive Model #. Use the □□□□ portion of the CIMR-E7□□□□ Model Number. Reference Appendix 2	0 to FF	kVA Dependent	Programming
o2-05	Frequency Reference Setting Method Selection Operator M.O.P.	Determines if the Data/Enter key must be used to input a frequency reference from the digital operator. 0: Disabled - Data/Enter key must be pressed to enter a frequency reference. 1: Enabled - Data/Enter key is not required. The frequency reference is adjusted by the up and down arrow keys on the digital operator without having to press the data/enter key.	0 or 1	1	Programming
o2-06	Operation Selection when Digital Operator is Disconnected Oper Detection	Determines if the Drive will stop when the digital operator is removed. 0: Disabled - The Drive will not stop when the digital operator is removed. 1: Enabled - The Drive will fault (OPR) and coast to stop when the operator is removed.	0 or 1	1	Programming
o2-07	Cumulative Operation Time Setting Elapsed Time Set	Sets the initial value of the elapsed operation timer.	0 to 65535	0H	Programming
◆ Denotes that parameter can be changed when the drive is running. ** Factory settings change when b5-01=1 as follows: o1-06=1, o1-07=38, o1-08=24.					

Table A.1 Parameter List (Continued)

Parameter No.	Parameter Name Digital Operator Display	Description	Setting Range	Factory Setting	Menu Location
o2-08	Cumulative Operation Time Selection Elapsed Time Run	Sets how time is accumulated for the elapsed timer (o2-07). 0: Power-On Time (Time accumulates whenever Drive is powered). 1: Running Time (Time accumulates only when Drive is running)	0 or 1	1	Programming
o2-09	Initialization Specification Selection Init Mode Sel	Determines parameter values after a Drive initialization (A1-03) is executed. This should always be set to "1" American Spec. 1: American spec 2: European spec 4: PV-A spec 5: PV-E spec 6: Chinese spec	1 to 5	1	Programming
o2-10	Cumulative Cooling Fan Operation Time Setting Fan ON Time Set	Sets the initial value of the heatsink fan operation time.	0 to 65535	0H	Programming
o2-12	Fault Trace/Fault History Clear Function FLT Trace Init	Clears the fault memory contained in the U2 and U3 monitors. 0: Disabled (no effect). 1: Enabled - resets U2 and U3 monitors, and returns o2-12 to zero.	0 or 1	0	Programming
o2-14	kWh User Monitor (U1-29) Initialization kWh MonitorClear	Used to reset the kilowatt Hour monitor to zero 0: Disabled (no change). 1: Clear all - Resets U1-29 to zero and returns o2-14 to zero.	0 or 1	0	Programming
o2-15	Hand Key Function Selection Oper Hand Key	Enables or disables the "Hand" key on the digital operator. 0: Disabled 1: Enabled	0 or 1	1	Programming
COPY Function					
o3-01	Copy Function Selection Copy Function Sel	This parameter controls the copying of parameters to and from the digital operator. 0: COPY SELECT (no function) 1: INV -> OP READ - All parameters are copied from the Drive to the digital operator. 2: OP -> INV WRITE - All parameters are copied from the digital operator into the Drive. 3: OP<->INV VERIFY - Parameter settings in the Drive are compared to those in the digital operator. NOTE: When using the copy function, the Drive model number and software number (U1-14) must match or an error will occur.	0 to 3	0	Programming
o3-02	Read Allowed Selection Read Allowable	Enables and disables all digital operator copy functions. 0: Disabled - No digital operator copy functions are allowed. 1: Enabled - Copying allowed	0 to 1	0	Programming
Auto-Tuning					
T1-02	Motor Rated Power Mtr Rated Power	Sets the motor rated power in kW. NOTE: T1-02 should be left at the default value (last 3 digits of the Drive model number).	0.00 to 650.00	kVA Dependent	Auto-Tuning
T1-04	Motor Rated Current Rated Current	Sets the motor rated current. (Used only during an auto-tune).	kVA Dependent	kVA Dependent	Auto-Tuning

Monitor List

Table A.2 Monitor List

Parameter No.	Parameter Name Digital Operator Display	Description
Monitor		
U1-01	Frequency Reference Frequency Ref	Frequency reference (speed command) monitor when in auto mode, frequency reference (speed command) setting location when in hand mode. Units changeable via o1-03.
U1-02	Output Frequency Output Freq	Output frequency (speed) monitor. Units changeable via o1-03.
U1-03	Output Current Output Current	Output current monitor
U1-06	Output Voltage Output Voltage	Displays Drive output voltage
U1-07	DC Bus Voltage DC Bus Voltage	Displays DC Bus Voltage
U1-08	Output Power Output kWatts	Displays Drive output power
U1-10	Input Terminal Status Input Term Sts	<p>Displays Drive input terminal status</p>
U1-11	Output Terminal Status Output Term Sts	<p>Output terminal ON/OFF Check</p>
U1-12	Drive Operation Status Int Ctl Sts 1	

Table A.2 Monitor List (Continued)

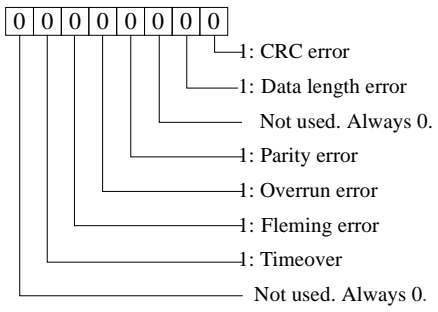
Parameter No.	Parameter Name Digital Operator Display	Description
Monitor		
U1-13	Cumulative Operation Time Elapsed Time	Displays total operating or power-on time of the Drive.
U1-14	Software Number FLASH ID	Displays Drive's software number.
U1-15	Terminal A1 Input Voltage Term A1 Level	Displays the input voltage on Terminal A1, as a percentage of 10V DC.
U1-16	Terminal A2 Input Voltage Term A2 level	Displays the input current (or voltage) on Terminal A2, as a percentage of 20mA (or 10 V DC).
U1-18	Motor Secondary Current (I _q) Mot SEC Current	Displays the amount of current being used by the motor to produce torque (I _q).
U1-20	Output Frequency After Soft Start SFS Output	Displays the frequency reference (speed command) after the accel and decel ramps.
U1-24	PI Feedback Value PI Feedback	Displays the feedback signal when PI control is used.*
U1-28	CPU Number CPU ID	Displays control board hardware revision.
U1-29	kWh kWh Lo 4 Digits	Displays the accumulated kWh.
U1-30	MWh kWh Hi 5 Digits	Displays the accumulated MWh.
U1-34	First Parameter Causing an OPE OPE Detected	Displays the parameter number causing an "OPE" fault.
U1-36	PI Input PI Input	Displays the "error" in the PI regulator. (U1-36 = PI Setpoint - PI Feedback).
U1-37	PI Output PI Output	Displays the output of the PI as a percentage of maximum frequency (E1-04).
U1-38	PI Setpoint PI Setpoint	Displays the setpoint of the PI regulator (U1-38 = PI reference + PI bias).*
U1-39	Memobus Communication Error Code Transmit Err	
U1-40	Heatsink Cooling Fan Operation Time FAN Elapsed Time	Displays total operating time of the heatsink cooling fan.
U1-51	Auto Mode Frequency Reference Value AUTO Mode Fref	Displays the frequency reference (speed command) when in auto mode.
U1-52	Hand Mode Frequency Reference Value HAND Mode Fref	Displays the frequency reference (speed command) when in hand mode, or displays Terminal A2 when differential mode is selected.
U1-53	PI Feedback 2 Value PI Feedback 2	Displays PI feedback 2 value.

* Units depend on b5-31 setting; scaling is set by b5-20

Fault Trace List

Table A.3 Fault Trace List

Fault Trace	
U2-01	Current Fault Current Fault
U2-02	Previous Fault Last Fault
U2-03	Frequency Reference at Most Recent Fault Frequency Ref
U2-04	Output Frequency at Most Recent Fault Output Freq
U2-05	Output Current at Most Recent Fault Output Current
U2-07	Output Voltage at Most Recent Fault Output Voltage
U2-08	DC Bus Voltage at Most Recent Fault DC Bus Voltage
U2-09	Output Power at Most Recent Fault Output kWatts
U2-11	Input Terminal Status at Most Recent Fault. The format is the same as for U1-10. Input Term Sts
U2-12	Output Terminal Status at Most Recent Fault. The format is the same as for U1-11. Output Term Sts
U2-13	Drive Operation Status at Most Recent Fault. The format is the same as for U1-12. Inverter Status
U2-14	Cumulative Operation Time at Most Recent Fault Elapsed time
(Note) Fault trace is not executed at CPF00, CPF01, CPF03, UVI and UV2.	

Fault History List

Table A.4 Fault History List

Fault History	
U3-01	Most Recent Fault Last Fault
U3-02	2 nd Most Recent Fault Fault Message 2
U3-03	3 rd Most Recent Fault Fault Message 3
U3-04	4 th Most Recent Fault Fault Message 4
U3-05	Cumulative Operation Time at Most Recent Fault Elapsed Time 1
U3-06	Cumulative Operation Time at 2 nd Most Recent Fault Elapsed Time 2
U3-07	Cumulative Operation Time at 3 rd Most Recent Fault Elapsed Time 3
U3-08	Cumulative Operation Time at 4 th Most Recent Fault Elapsed Time 4
U3-09	5 th Most Recent Fault Fault Message 5
U3-10	6 th Most Recent Fault Fault Message 6
U3-11	7 th Most Recent Fault Fault Message 7
U3-12	8 th Most Recent Fault Fault Message 8
U3-13	9 th Most Recent Fault Fault Message 9
U3-14	10 th Most Recent Fault Fault Message 10
U3-15	Cumulative Operation Time at 5 th Most Recent Fault Elapsed Time 5
U3-16	Cumulative Operation Time at 6 th Most Recent Fault Elapsed Time 6
U3-17	Cumulative Operation Time at 7 th Most Recent Fault Elapsed Time 7
U3-18	Cumulative Operation Time at 8 th Most Recent Fault Elapsed Time 8
U3-19	Cumulative Operation Time at 9 th Most Recent Fault Elapsed Time 9
U3-20	Cumulative Operation Time at 10 th Most Recent Fault Elapsed Time 10
(Note) Faults such as CPF00, CPF01, CPF02, CPF03, UV1, and UV02 are not stored in fault history.	

Notes:

Appendix B

Factory Default Settings

This appendix lists the factory default settings for the parameters affected by setting of o2-04.

Factory Default Settings	B-2
--------------------------------	-----

The following tables detail the factory default settings for the parameters that are affected by the setting of parameter o2-04.

Table B.1 208/240VAC Drives											
Drive Model CIMR-E7U	Nominal Hp	Factory Default for b8-04	Factory Default for C6-02	Factory Default for E2-01	Factory Default for E2-03	Factory Default for E2-05	Factory Default for L2-02	Factory Default for L2-03	Factory Default for L2-04	Factory Default for L8-02	Factory Default for L8-06
20P4	0.5/0.75	288.2	10kHz	1.9	1.2	9.842	0.1	0.1	0.3	95°C	5
20P7	2	223.7	10kHz	3.3	1.8	5.156	0.1	0.2	0.3	95°C	7.5
21P5	1.5/2	169.4	10kHz	6.2	2.8	1.997	0.2	0.3	0.3	95°C	10
22P2	3	156.8	8kHz	8.5	3.0	1.601	0.3	0.4	0.3	100°C	12
23P7	5	122.9	10kHz	14.0	4.5	0.771	0.5	0.5	0.3	95°C	12
25P5	7.5	94.75	15kHz	19.6	5.1	0.399	1.0	0.6	0.3	95°C	10
27P5	10	72.69	15kHz	26.6	8.0	0.288	1.0	0.7	0.3	95°C	17
2011	15	70.44	8kHz	39.7	11.2	0.230	1.0	0.8	0.3	95°C	21
2015	20	63.13	10kHz	53.0	15.2	0.138	2.0	0.9	0.3	90°C	17
2018	25	57.87	10kHz	65.8	15.7	0.101	2.0	1.0	0.6	100°C	15
2022	30	51.79	10kHz	77.2	18.5	0.079	2.0	1.0	0.6	90°C	24
2030	40	46.27	10kHz	105.0	21.9	0.064	2.0	1.1	0.6	90°C	20
2037	50	38.16	5kHz	131.0	38.2	0.039	2.0	1.1	0.6	95°C	18
2045	60	35.78	5kHz	160.0	44.0	0.030	2.0	1.2	0.6	100°C	20
2055	75	31.35	8kHz	190.0	45.6	0.022	2.0	1.2	0.1	105°C	17
2075	75/100	23.10	2kHz	260.0	72.0	0.023	2.0	1.3	0.1	110°C	16
2090	125	20.65	2kHz	260.0	72.0	0.023	2.0	1.5	0.1	100°C	18
2110	150	18.12	2kHz	260.0	72.0	0.023	2.0	1.7	0.1	95°C	20

Note: b8-04 = Energy Savings Coefficient
C6-02 = Carrier Frequency
E2-01 = Motor Rated Current
E2-03 = Motor No-Load Current
E2-05 = Motor Line-to-Line Resistance
L2-02 = Momentary Power Loss Ride-Thru Time
L2-03 = Momentary Power Loss Minimum Base Block Time
L2-04 = Momentary Power Loss Voltage Recovery Ramp Time
L8-02 = Overheat Pre-Alarm Level
L8-06 = Input Phase Loss Detection Level

Table B.2 480VAC Drives

Drive Model CIMR-E7U	Nominal Hp	Factory Default for b8-04	Factory Default for C6-02	Factory Default for E2-01	Factory Default for E2-03	Factory Default for E2-05	Factory Default for L2-02	Factory Default for L2-03	Factory Default for L2-04	Factory Default for L8-02	Factory Default for L8-06
40P4	0.5/0.75	576.40	15kHz	1.0	0.6	38.198	0.1	0.1	0.3	95°C	5
40P7	1	447.40	15kHz	1.6	0.8	22.459	0.1	0.2	0.3	95°C	7.5
41P5	1.5/2	338.80	15kHz	3.1	1.4	10.100	0.2	0.3	0.3	95°C	10
42P2	3	313.60	15kHz	4.2	1.5	6.495	0.3	0.4	0.3	90°C	10
43P7	5	245.80	15kHz	7.0	2.3	3.333	0.5	0.5	0.3	95°C	12
45P5	7.5	189.50	15kHz	13.3	2.6	1.595	1.0	0.6	0.3	95°C	10
47P5	10	145.38	15kHz	19.9	4.0	1.152	1.0	0.7	0.3	90°C	20
4011	15/20	140.88	8kHz	26.5	5.6	0.922	2.0	0.8	0.3	95°C	23
4015	25	126.26	10kHz	32.9	7.6	0.550	2.0	0.9	0.3	95°C	17
4018	30	115.74	10kHz	52.3	7.8	0.403	2.0	1.0	0.6	98°C	17
4030	40/50	92.54	8kHz	65.6	10.9	0.269	2.0	1.1	0.6	85°C	20
4037	60	76.32	8kHz	79.7	19.1	0.155	2.0	1.1	0.6	85°C	20
4045	75	71.56	8kHz	95.0	22.0	0.122	2.0	1.2	0.6	90°C	20
4055	100	67.20	5kHz	130.0	24.0	0.088	2.0	1.2	1.0	90°C	20
4075	125	46.20	5kHz	130.0	36.0	0.092	2.0	1.3	1.0	98°C	16
4090	150	38.91	8kHz	156.0	40.0	0.056	2.0	1.5	1.0	108°C	16
4110	200	36.23	5kHz	190.0	49.0	0.046	2.0	1.7	1.0	100°C	16
4160	250	30.13	5kHz	270.0	70.0	0.029	2.0	1.8	1.0	108°C	14
4185	300/350	30.57	2kHz	310.0	81.0	0.025	2.0	0.7	1.0	95°C	15
4220	400/450	27.13	2kHz	370.0	96.0	0.020	2.0	0.8	1.0	100°C	15
4300	500+	21.76	2kHz	500.0	130.0	0.014	2.1	0.9	1.0	95°C	15

Note: b8-04 = Energy Savings Coefficient

C6-02 = Carrier Frequency

E2-01 = Motor Rated Current

E2-03 = Motor No-Load Current

E2-05 = Motor Line-to-Line Resistance

L2-02 = Momentary Power Loss Ride-Thru Time

L2-03 = Momentary Power Loss Minimum Base Block Time

L2-04 = Momentary Power Loss Voltage Recovery Ramp Time

L8-02 = Overheat Pre-Alarm Level

L8-06 = Input Phase Loss Detection Level

Notes:

Drives Technical Support in USA and Canada

Technical Support for Inverters and Drives is available by phone as follows:

Normal: Monday through Friday during the hours of 8 a.m. to 5:00 p.m. C.S.T.

Emergency: After normal hours, 7 days a week including weekends and holidays

To contact Drives Technical Support, please call 1-800-YASKAWA (927-5292).

From the menu, dial 2 for Inverter and Drive Products, then 5 for Technical Support.

Drives Technical Support can also be reached by e-mail at DriveSupport@yaskawa.com.

Support information, such as technical manuals, FAQs, instruction sheets and software downloads are available at our website, www.drives.com.

When calling for technical support, please have the following materials available:

- The appropriate Technical Manual in hand because the support associate may refer to this
- Complete nameplate information from the drive and the motor.
(Confirm that Drive Nameplate Output amps is equal to or greater than Motor Nameplate amps)
- A list with your parameter settings
- A sketch of the electrical power train, from AC line to motor, including filters and disconnects

Field Service, Start Up Assistance, Factory Repair, Replacement Parts, and Other Support

Contact Drives Technical Support for help with any of these needs.

Technical Training

Training is conducted at Yaskawa training centers, at customer sites, and via the internet.

For information, visit www.drives.com or call 1-800-YASKAWA (927-5292).

From the phone menu, dial 2 for Inverter and Drive Products, then 4 for Product Training.

Support in Other Countries

Yaskawa is a multi-national company with offices and service representation around the world.

To obtain support, always contact the local distributor first for guidance and assistance.

Contact the closest Yaskawa office listed for further assistance.

YASKAWA ELECTRIC AMERICA, INC.

Drives Division
16555 W. Ryerson Rd., New Berlin, WI 53151, U.S.A.
Phone: (800) YASKAWA (800-927-5292) Fax: (262) 782-3418
Internet: <http://www.drives.com>

YASKAWA ELECTRIC AMERICA, INC.

Chicago-Corporate Headquarters
2121 Norman Drive South, Waukegan, IL 60085, U.S.A.
Phone: (800) YASKAWA (800-927-5292) Fax: (847) 887-7310
Internet: <http://www.yaskawa.com>

MOTOMAN INC.

805 Liberty Lane, West Carrollton, OH 45449, U.S.A.
Phone: (937) 847-6200 Fax: (937) 847-6277
Internet: <http://www.motoman.com>

YASKAWA ELECTRIC CORPORATION

New Pier Takeshiba South Tower, 1-16-1, Kaigan, Minatoku, Tokyo, 105-0022, Japan
Phone: 81-3-5402-4511 Fax: 81-3-5402-4580
Internet: <http://www.yaskawa.co.jp>

YASKAWA ELETRICO DO BRASIL COMERCIO LTDA.

Avenida Fagundes Filho, 620 Bairro Saude Sao Paulo-SP, Brasil CEP: 04304-000
Phone: 55-11-5071-2552 Fax: 55-11-5581-8795
Internet: <http://www.yaskawa.com.br>

YASKAWA ELECTRIC EUROPE GmbH

Am Kronberger Hang 2, 65824 Schwalbach, Germany
Phone: 49-6196-569-300 Fax: 49-6196-888-301

MOTOMAN ROBOTICS AB

Box 504 S38525, Torsas, Sweden
Phone: 46-486-48800 Fax: 46-486-41410

MOTOMAN ROBOTEC GmbH

Kammerfeldstrabe 1, 85391 Allershausen, Germany
Phone: 49-8166-900 Fax: 49-8166-9039

YASKAWA ELECTRIC UK LTD.

1 Hunt Hill Orchardton Woods Cumbernauld, G68 9LF, Scotland, United Kingdom
Phone: 44-12-3673-5000 Fax: 44-12-3645-8182

YASKAWA ELECTRIC KOREA CORPORATION

Paik Nam Bldg. 901 188-3, 1-Ga Euljiro, Joong-Gu, Seoul, Korea
Phone: 82-2-776-7844 Fax: 82-2-753-2639

YASKAWA ELECTRIC (SINGAPORE) PTE. LTD.

Head Office: 151 Lorong Chuan, #04-01, New Tech Park Singapore 556741, Singapore
Phone: 65-282-3003 Fax: 65-289-3003

TAIPEI OFFICE (AND YATEC ENGINEERING CORPORATION)

10F 146 Sung Chiang Road, Taipei, Taiwan
Phone: 886-2-2563-0010 Fax: 886-2-2567-4677

YASKAWA JASON (HK) COMPANY LIMITED

Rm. 2909-10, Hong Kong Plaza, 186-191 Connaught Road West, Hong Kong
Phone: 852-2803-2385 Fax: 852-2547-5773

BEIJING OFFICE

Room No. 301 Office Building of Beijing International Club,
21 Jianguomanwai Avenue, Beijing 100020, China
Phone: 86-10-6532-1850 Fax: 86-10-6532-1851

SHANGHAI OFFICE

27 Hui He Road Shanghai 200437 China
Phone: 86-21-6553-6600 Fax: 86-21-6531-4242

SHANGHAI YASKAWA-TONJI M & E CO., LTD.

27 Hui He Road Shanghai 200437 China
Phone: 86-21-6533-2828 Fax: 86-21-6553-6677

BEIJING YASKAWA BEIKE AUTOMATION ENGINEERING CO., LTD.

30 Xue Yuan Road, Haidian, Beijing 100083 China
Phone: 86-10-6232-9943 Fax: 86-10-6234-5002

SHOUGANG MOTOMAN ROBOT CO., LTD.

7, Yongchang-North Street, Beijing Economic & Technological Development Area,
Beijing 100076 China
Phone: 86-10-6788-0551 Fax: 86-10-6788-2878

YEA, TAICHUNG OFFICE IN TAIWAN

B1, 6F, No.51, Section 2, Kung-Yi Road, Taichung City, Taiwan, R.O.C.
Phone: 886-4-2320-2227 Fax: 886-4-2320-2239