



MILLENNIUM[®]
CENTRIFUGAL LIQUID CHILLERS

OPERATING & MAINTENANCE

Supersedes: 160.55-01 (402)

Form 160.55-01 (604)

MODEL YT (STYLE J)
R123 COOLING ONLY

**WITH OPTIVIEW™ CONTROL CENTER
FOR ELECTRO-MECHANICAL STARTER,
SOLID STATE STARTER & VARIABLE SPEED DRIVE**



29509A

IMPORTANT!

READ BEFORE PROCEEDING!

GENERAL SAFETY GUIDELINES

This equipment is a relatively complicated apparatus. During installation, operation, maintenance or service, individuals may be exposed to certain components or conditions including, but not limited to: refrigerants, oils, materials under pressure, rotating components and both high and low voltage. Each of these items has the potential, if misused or handled improperly, to cause bodily injury or death. It is the obligation and responsibility of operating/service personnel to identify and recognize these inherent hazards, protect themselves and proceed safely in completing their tasks. Failure to comply with any of these requirements could result in serious damage to the equipment and the property in

which it is situated, as well as severe personal injury or death to themselves and people at the site.

This document is intended for use by owner-authorized operating/service personnel. It is expected that this individual possesses independent training that will enable them to perform their assigned tasks properly and safely. It is essential that, prior to performing any task on this equipment, this individual shall have read and understood this document and any referenced materials. This individual shall also be familiar with and comply with all applicable governmental standards and regulations pertaining to the task in question.

SAFETY SYMBOLS

The following symbols are used in this document to alert the reader to areas of potential hazard:



DANGER indicates an imminently hazardous situation which, if not avoided, will result in death or serious injury.



CAUTION identifies a hazard which could lead to damage to the machine, damage to other equipment and/or environmental pollution. Usually an instruction will be given, together with a brief explanation.



WARNING indicates a potentially hazardous situation which, if not avoided, could result in death or serious injury.



NOTE is used to highlight additional information which may be helpful to you.



External wiring, unless specified as an optional connection in the manufacturer's product line, is NOT to be connected inside the micro panel cabinet. Devices such as relays, switches, transducers and controls may NOT be installed inside the micro panel. NO external wiring is allowed to be run through the micro panel. All wiring must be in accordance with YORK's published specifications and must be performed ONLY by qualified YORK personnel. YORK will not be responsible for damages/problems resulting from improper connections to the controls or application of improper control signals. Failure to follow this will void the manufacturer's warranty and cause serious damage to property or injury to persons.

CHANGEABILITY OF THIS DOCUMENT

In complying with YORK's policy for continuous product improvement, the information contained in this document is subject to change without notice. While YORK makes no commitment to update or provide current information automatically to the manual owner, that information, if applicable, can be obtained by contacting the nearest YORK Applied Systems Service office.

It is the responsibility of operating/service personnel as to the applicability of these documents to the equipment in question. If there is any question in the mind of operating/service personnel as to the applicability of these documents, then, prior to working on the equipment, they should verify with the owner whether the equipment has been modified and if current literature is available.

REFERENCE INSTRUCTIONS

DESCRIPTION	FORM NO.
SOLID STATE STARTER (MOD "A") – OPERATION & MAINTENANCE	160.46-OM3.1
SOLID STATE STARTER (MOD "B") – OPERATION & MAINTENANCE	160.00-02
VARIABLE SPEED DRIVE – OPERATION	160.00-O1
VARIABLE SPEED DRIVE – SERVICE INSTRUCTIONS	160.00-M1
INSTALLATION	160.55-N1
OPTIVIEW CONTROL CENTER - SERVICE INSTRUCTIONS	160.55-M1
WIRING DIAGRAM – UNIT WITH ELECTRO-MECHANICAL STARTER	160.55-PW1
WIRING DIAGRAM – UNIT WITH SOLID STATE STARTER (MOD "B")	160.55-PW2
WIRING DIAGRAM – UNIT WITH VARIABLE SPEED DRIVE	160.55-PW3
RENEWAL PARTS – UNIT	160.48-RP5
RENEWAL PARTS – GRAPHIC CONTROL CENTER	160.55-RP1

NOMENCLATURE

The model number denotes the following characteristics of the unit

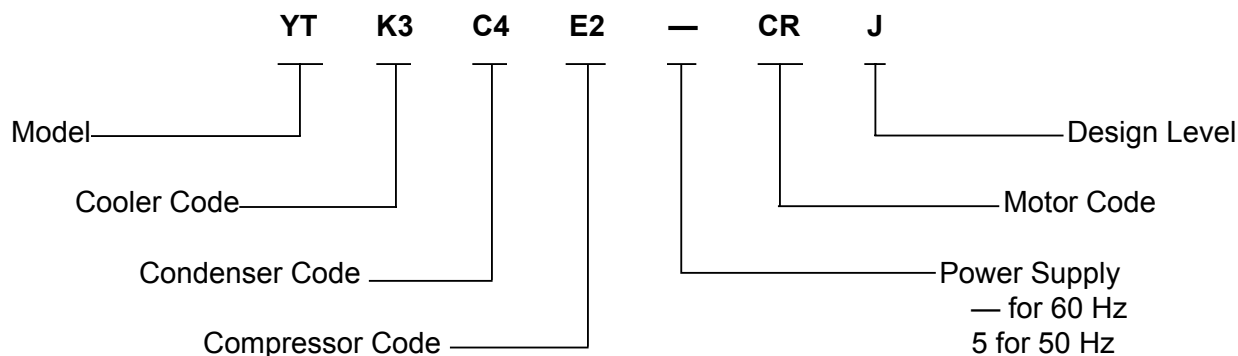

TABLE OF CONTENTS

SECTION	1	Description of System and Fundamentals of Operation.....	7
SECTION	2	OptiView Control Center	9
SECTION	3	Printers	112
SECTION	4	System Operating Procedures	124
SECTION	5	System Components Description	131
SECTION	6	Operational Maintenance	135
SECTION	7	Troubleshooting.....	138
SECTION	8	Maintenance	144
SECTION	9	Preventive Maintenance	152
SECTION	10	OptiSave Energy Analyser Feature	154

LIST OF FIGURES

FIG. 1	– MODEL YT MILLENNIUM CHILLER	7	FIG. 33	– HISTORY SCREEN	76
FIG. 2	– REFRIGERANT FLOW-THROUGH CHILLER	8	FIG. 34	– HISTORY DETAILS SCREEN	78
	DETAIL A – COMPRESSOR PREROTATION		FIG. 35	– SECURITY LOG SCREEN	79
	VANES	8	FIG. 36	– SECURITY LOG DETAILS SCREEN	80
FIG. 3	– CONTROL CENTER	12	FIG. 37	– TREND SCREEN	82
FIG. 4	– HOME SCREEN	16	FIG. 38	– TREND SETUP SCREEN	84
FIG. 5	– SYSTEM SCREEN	18	FIG. 39	– ADVANCED TREND SETUP SCREEN	86
FIG. 6	– EVAPORATOR SCREEN	20	FIG. 40	– COMMON SLOTS SCREEN	88
FIG. 7	– CONDENSER SCREEN	22	FIG. 41	– CUSTOM VIEW SCREEN	89
FIG. 8	– PURGE SCREEN	24	FIG. 42	– CUSTOM VIEW SETUP SCREEN	90
FIG. 9	– REFRIGERANT LEVEL CONTROL SCREEN ...	26	FIG. 43	– PRINTERS	112
FIG. 10	– COMPRESSOR SCREEN	28	FIG. 44	– SAMPLE PRINTOUT (STATUS)	116
FIG. 11	– HOT GAS BYPASS SCREEN	30	FIG. 45	– SAMPLE PRINTOUT (SETPOINTS)	110
FIG. 12	– SURGE PROTECTION SCREEN	32	FIG. 46	– SAMPLE PRINTOUT (SCHEDULE)	119
FIG. 13	– PRE-ROTATION VANES CALIBRATION		FIG. 47	– SAMPLE PRINTOUT (SALES ORDER)	120
	SCREEN	36	FIG. 48	– SAMPLE PRINTOUT (HISTORY)	121
FIG. 14	– VSD TUNING SCREEN	38	FIG. 49	– SAMPLE PRINTOUT (SECURITY LOG)	122
FIG. 15	– OIL SUMP SCREEN	40	FIG. 50	– SAMPLE PRINTOUT (TREND)	123
FIG. 16	– ELECTRO-MECHANICAL STARTER SCREEN	41	FIG. 51	– SAMPLE PRINTOUT	
FIG. 17	– SOLID STATE STARTER			(CUSTOM SCREEN REPORT)	123
	(MOD A) SCREEN	42	FIG. 52	– SAMPLE PRINTOUT	
FIG. 18	– SOLID STATE STARTER			(ADAPTIVE CAPACITY CONTROL NEW MAP	
	(MOD B) SCREEN	44		POINT REPORT)	123
FIG. 19	– VARIABLE SPEED DRIVE SCREEN	46	FIG. 53	– SAMPLE PRINTOUT	
FIG. 20	– VARIABLE SPEED DRIVE DETAILS SCREEN			(ADAPTIVE CAPACITY CONTROL EXISTING	
	(All VSD except Part Number 371-02767-XXX			MAP POINTS REPORT)	123
	(60 Hz) or 371-03700-XXX (50 Hz))	48	FIG. 54	– OPERATION SEQUENCE & TIMING	
FIG. 21	– VARIABLE SPEED DRIVE DETAILS SCREEN			DIAGRAM (ELECTRO-MECHANICAL	
	(VSD with Part Number 371-02767-XXX			& SOLID STATE STARTER APPLICATIONS) ..	126
	(60 Hz) or 371-03700-XXX (50 Hz))	50	FIG. 55	– OPERATION SEQUENCE & TIMING	
FIG. 22	– ADAPTIVE CAPACITY CONTROL DETAILS			DIAGRAM (COMPRESSOR MOTOR	
	SCREEN	52		VARIABLE SPEED DRIVE APPLICATIONS) ...	126
FIG. 23	– HARMONIC FILTER DETAILS SCREEN		FIG. 56	– MINIMUM ENTERING CONDENSING	
	(All VSD except Part Number 371-02767-XXX			WATER TEMPERATURE	127
	(60 Hz) or 371-03700-XXX (50 Hz))	54	FIG. 57	– LIQUID CHILLER LOG SHEETS	127
FIG. 24	– HARMONIC FILTER DETAILS SCREEN		FIG. 58	– TURBOGUARD PURGE UNIT	129
	(VSD with Part Number 371-02767-XXX (60 Hz)		FIG. 59	– SCHEMATIC DRAWING (YT) COMPRESSOR	
	or 371-03700-XXX (50 Hz))	56		LUBRICATION SYSTEM	132
FIG. 25	– SETPOINTS SCREEN	58	FIG. 60	– OIL RETURN SYSTEM	135
FIG. 26	– SETUP SCREEN	60	FIG. 61	– ASSEMBLY OF DEHYDRATOR	136
FIG. 27	– SCHEDULE SCREEN	64	FIG. 62	– CHARGING OIL RESERVOIR WITH OIL	137
FIG. 28	– USER SCREEN	66	FIG. 63	– EVACUATION OF CHILLER	145
FIG. 29	– COMMS SCREEN	68	FIG. 64	– SATURATION CURVE	147
FIG. 30	– PRINTER SCREEN	70	FIG. 65	– DIAGRAM - MEGGING MOTOR WINDINGS ..	149
FIG. 31	– SALES ORDER SCREEN	72	FIG. 66	– MOTOR STATOR TEMPERATURE &	
FIG. 32	– OPERATIONS SCREEN	74		INSULATION RESISTANCES	150

SECTION 1

DESCRIPTION OF SYSTEM AND FUNDAMENTALS OF OPERATION

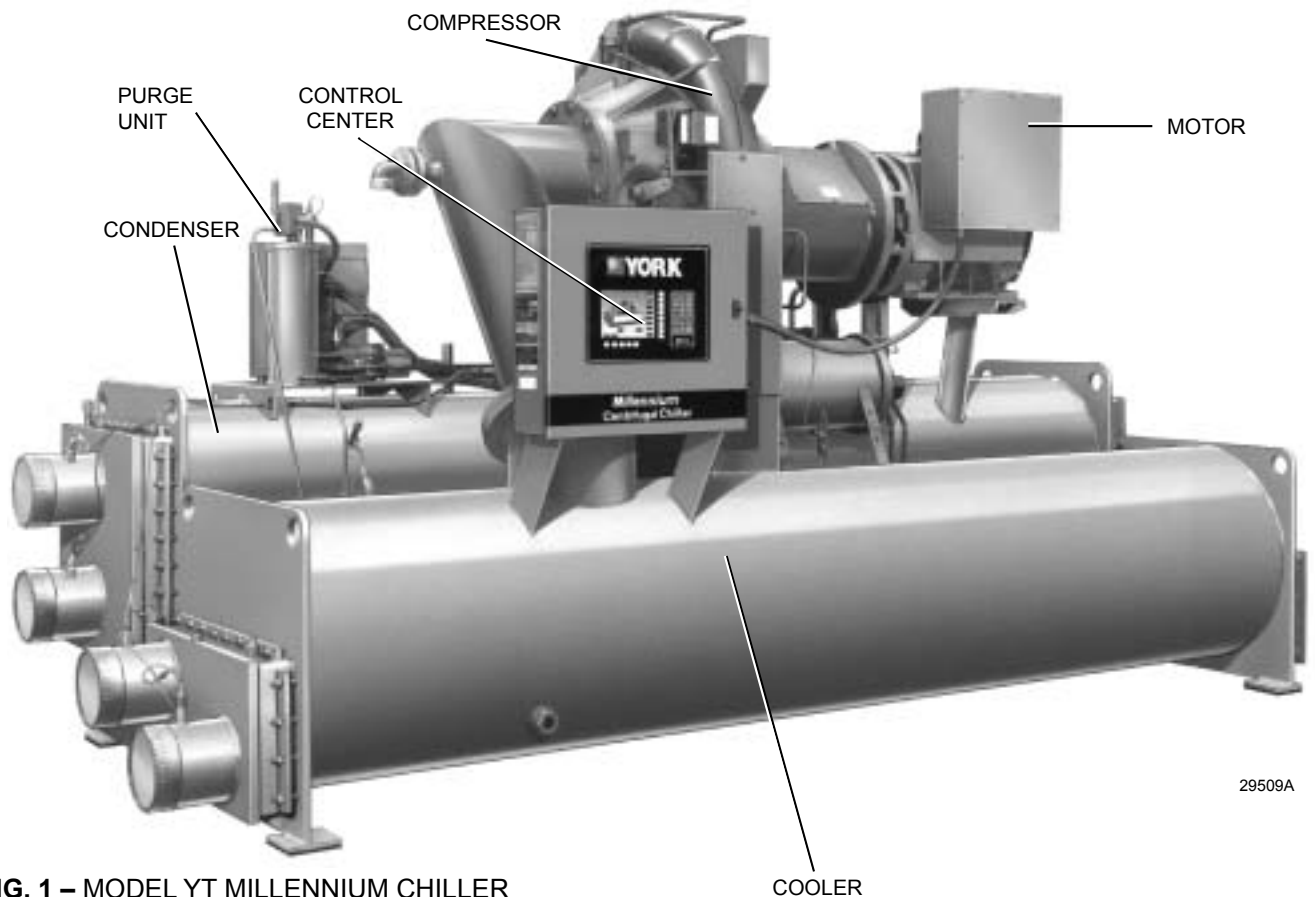

FIG. 1 – MODEL YT MILLENNIUM CHILLER

SYSTEM OPERATION DESCRIPTION (SEE FIG. 2)

The YORK Model YT Millennium Chiller is commonly applied to large air conditioning systems, but may be used on other applications. The chiller consists of an open motor mounted to a compressor (with integral speed increasing gears) condenser, cooler and variable flow control.

The chiller is controlled by a modern state of the art OptiView Control Center that monitors its operation. The Control Center is programmed by the operator to suit job specifications. Automatic timed start-ups and shutdowns are also programmable to suit nighttime, weekends and holidays. The operating status, temperatures, pressures and other information pertinent to operation of the chiller are automatically displayed and read on a graphic message display. Other displays can be observed by pressing the keys as labeled on the Control Center. The chiller with the OptiView Control Center is applied with an electro-mechanical starter, YORK Solid State Starter (optional) or Variable Speed Drive (optional).

There could be either of two different Solid State Starters applied. New production chillers are equipped with the Mod “B” Solid State Starter. This starter contains a

combination Logic/Trigger Board that interfaces the Control Center with a serial communications link. Earlier vintage chillers, such as those encountered in Control Center retrofit applications are equipped with the Mod “A” starter. This Starter contains a Trigger Board that interfaces to a Logic Board that is installed inside of the Control Center.

In operation, a liquid (water or brine to be chilled) flows through the cooler, where boiling refrigerant absorbs heat from the liquid. The chilled liquid is then piped to fan coil units or other air conditioning terminal units, where it flows through finned coils, absorbing heat from the air. The warmed liquid is then returned to the chiller to complete the chilled liquid circuit.

The refrigerant vapor, which is produced by the boiling action in the cooler, flows to the compressor where the rotating impeller increases its pressure and temperature and discharges it into the condenser. Water flowing through the condenser tubes absorbs heat from the refrigerant vapor, causing it to condense. The condenser water is supplied to the chiller from an external source, usually a cooling tower. The condensed refrigerant drains from the condenser into the liquid return line, where the vari-



7619A(D)

DETAIL A – COMPRESSOR PREROTATION VANES

able orifice meters the flow of liquid refrigerant to the cooler to complete the refrigerant circuit.

The major components of a chiller are selected to handle the refrigerant, which would be evaporated at full load design conditions. However, most systems will be called upon to deliver full load capacity for only a relatively small part of the time the unit is in operation.

CAPACITY CONTROL

The major components of a chiller are selected for full load capacities, therefore capacity must be controlled to maintain a constant chilled liquid temperature leaving the cooler. Prerotation vanes (PRV), located at the entrance to the compressor impeller, compensate for variation in load (See Fig. 2, Detail A).

The position of these vanes is automatically controlled through a lever arm attached to an electric motor located outside the compressor housing. The automatic adjustment of the vane position in effect provides the performance of many different compressors to match various load conditions from full load with vanes wide open to minimum load with vanes completely closed.

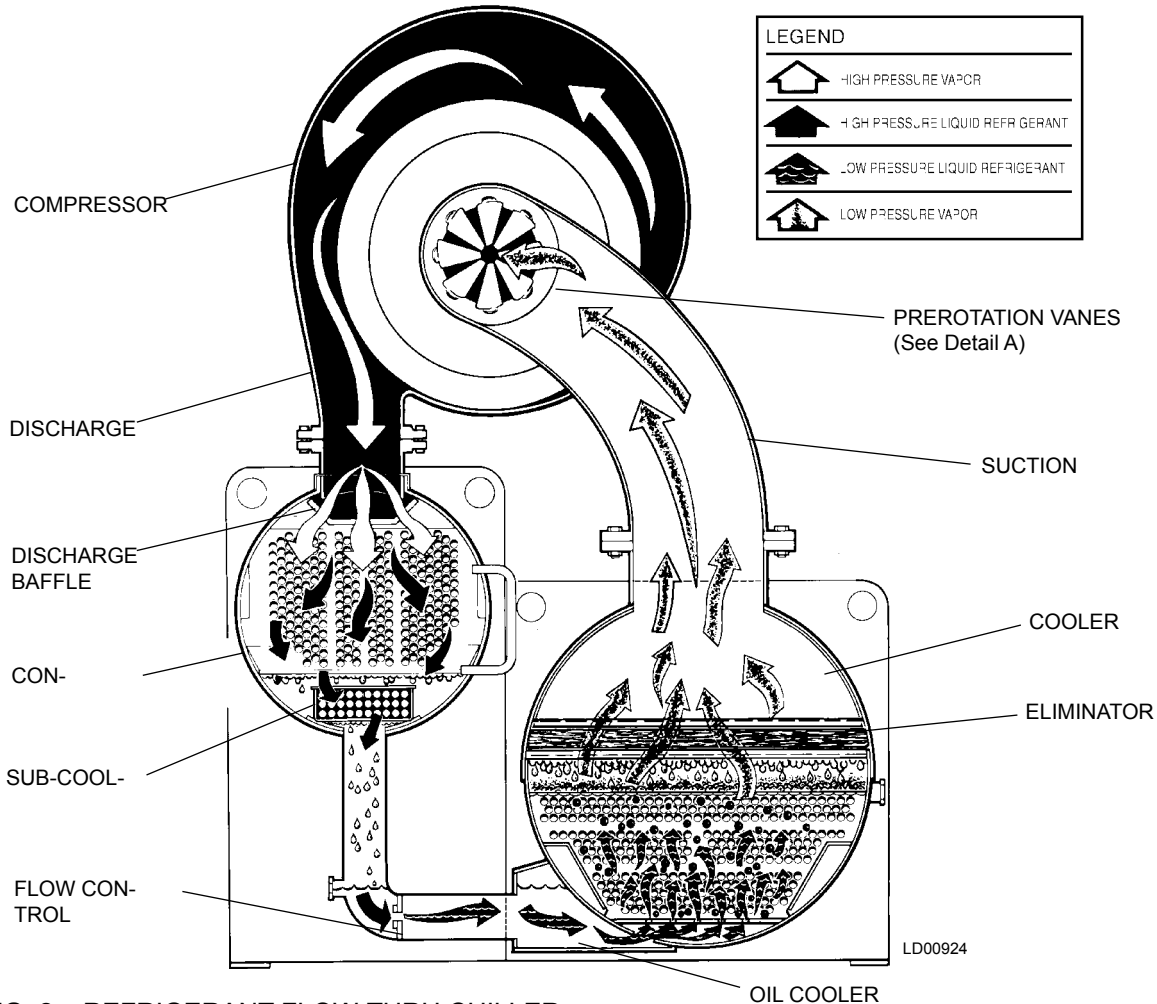

FIG. 2 – REFRIGERANT FLOW-THRU CHILLER

SECTION 2

OPTIVIEW CONTROL CENTER

INTRODUCTION

The YORK OptiView Control Center is a microprocessor based control system for R-11 or R123 centrifugal chillers. It controls the leaving chilled liquid temperature via pre-rotation vane controls and has the ability to limit motor current via control of the pre-rotation vanes. It is compatible with YORK Solid State Starter (optional), Variable Speed Drive (optional) and Electro-Mechanical starter applications.

The panel comes configured with a full screen LCD Graphic Display mounted in the middle of a keypad interface. The graphic display allows the presentation of several operating parameters at once. In addition, the operator may view a graphical representation of the historical operation of the chiller as well as the present operation. For the novice user, the locations of various chiller parameters are clearly and intuitively marked. Instructions for specific operations are provided on many of the screens.

The graphic display also allows information to be represented in both English (temperatures in °F and pressures in PSIA) and Metric (temperatures in °C and pressures in kPa) mode. The advantages are most apparent, however, in the ability to display many languages.

The Control Center continually monitors the system operation and records the cause of any shutdowns (Safety, Cycling or Normal). This information is recorded in memory and is preserved even through a power failure condition. The user may recall it for viewing at any time. During operation, the user is continually advised of the operating conditions by various status and warning messages. In addition, it may be configured to notify the user of certain conditions via alarms. A complete listing of shutdown, status and warning messages is attached in the **Display Messages** section of this book.

There are certain screens, displayed values, programmable Setpoints and manual control shown in this book that are for Service Technician use only. They are only displayed when logged in at **SERVICE** access level or higher. The Setpoints and parameters displayed on these screens are explained in detail in YORK Service Manual 160.55-M1. **These parameters affect chiller operation and should NEVER be modified by anyone other than a qualified Service Technician. They are shown in this book for reference only.**

Advanced Diagnostics and troubleshooting information for Service Technicians are included in YORK Service Manual 160.55-M1. Also included in the Service manual are detailed descriptions of chiller features, such as the Refrigerant Level Control (Future), Purge system, Hot Gas Bypass, Remote Setpoints and Smart Freeze Protection.

The control center expands the capabilities of remote control and communications. By providing a common networking protocol through the ISN GPIC YORK Chillers not only work well individually, but also as a team. This new protocol allows increased remote control of the chiller, as well as 24-hour performance monitoring via a remote site. In addition, compatibility is maintained with the present network of ISN communications. The chiller also maintains the standard digital remote capabilities as well. Both of these remote control capabilities allow for the standard Energy Management System (EMS) interface:

1. Remote Start
2. Remote Stop
3. Remote Leaving Chilled Liquid Temperature Setpoint adjustment (0-20mA or 4-20mA, 0-10VDC or 2-10VDC) or Pulse Width Modulation
4. Remote Current Limit Setpoint adjustment (0-20mA or 4-20mA, 0-10VDC or 2-10VDC) or Pulse Width Modulation
5. Remote "Ready to Start" Contacts
6. Safety Shutdown Contacts
7. Cycling Shutdown Contacts

The chiller operating program resides in the Optiview control center Microboard. The control center could be equipped with either of the following Microboards:

- 031-01730-000 – shipped in new production chillers until September 2003. The program resides in a replaceable Flash Memory Card. The software version (C.MLM.02.xx.yzz) is printed on label adhered to card. Program can be upgraded by replacing the card.
- 031-02430-000 – shipped in new production chillers after September 2003. The program resides in non-removable onboard memory. The software

version is C.OPT.02.xx.yzz, and is viewable on the DIAGNOSTICS Screen in SERVICE access level. The program can be upgraded by downloading a new program from a Program Card. Program Cards are shirt-pocket-size portable memory storage devices available from YORK.

Earlier vintage chillers could be equipped with a later Microboard due to service replacement.

Software versions (C.MLM.02.xx.yzz or C.OPT.02.xx.yzz) are alpha-numeric codes that represent the application, language package and revision levels per below. Each time the controls portion or language section is revised, the respective revision level increments.

- C – Commercial chiller
- MLM – Used on Microboard 031-01730-000
- OPT - Used on Microboard 031-02430-000
- 02 – YT chiller
- xx - controls revision level (00, 01, etc)
- y – language package (0=English only, 1=NEMA, 2=CE, 3=NEMA/CE)
- zz – language package revision level (00, 01, etc)

Throughout this book, reference is made to functions and features that are only available in certain Flash Memory Card revision levels (C.MLM.02.xx.xxx). To cross reference C.MLM software to C.OPT software, refer to the controls revision level. Software version C.OPT.02.04B.xxx is of the same controls revision level as C.MLM.02.04.xxx. From this starting point, both receive the same updates at each revision. Software upgrades should only be performed by a Service Technician.

**THIS PAGE INTENTIONALLY LEFT BLANK
TO MAINTAIN FORMAT**

CONTROL CENTER



FIG. 3

00134VIP

The OptiView Control Center display is highlighted by a full screen graphics display. This display is nested within a standard keypad and is surrounded by “soft” keys which are redefined based on the currently displayed screen. Eight buttons are available on the right side of the panel and are primarily used for navigation between the system screens. At the base of the display are 5 additional buttons. The area to the right of the keypad is used for data entry with a standard numeric keypad provided for entry of system setpoints and limits.



The *Decimal* key provides accurate entry of setpoint values.



A +/- key has also been provided to allow entry of negative values and AM/PM selection during time entry.



In order to accept changes made to the chiller setpoints, the *Check* key is provided as a universal ‘Enter’ key or ‘Accept’ symbol.



In order to reject entry of a setpoint or dismiss an entry form, the ‘X’ key is provided as a universal ‘Cancel’ symbol.



Cursor Arrow keys are provided to allow movement on screens which contain a large amount of entry data. In addition, these keys can be used to scroll through history and event logs.

The Start/Stop control is operated via a three-position rocker switch. When toggled all the way to the right, it is considered in the **STOP/RESET** position. When in the

middle position, this is considered the **RUN** state. When toggled to the left-most position, it is considered in the **START** state. Each state is described in detail below:

- **STOP / RESET (O)**

When in this position, the chiller will not run under any condition. For safety reasons, this position is required for many maintenance tasks to be completed (such as proximity probe and vane calibration). In addition, the switch must be placed in this state following a Safety shutdown before the chiller is allowed to restart. This guarantees that manual intervention has taken place and the shutdown has been acknowledged.

- **START (◀)**

The switch can only remain in this position when being acted upon by a manual force. Once the user has released the switch, it automatically reverts to the RUN position. Generally, this state only occurs momentarily as the operator attempts to locally start the unit. Once this position has been sensed, if all fault conditions are cleared, the unit will enter the system prelube (start sequence).

- **RUN (■)**

When in this position, the chiller is able to operate. The switch spring-returns to this state after it has been toggled to the **START** position. When in this state, the chiller is allowed to function normally and will also allow the chiller to automatically restart following a Cycling shutdown. The switch must be in this state to receive a valid remote start signal when operating under a remote control source.

INTERFACE CONVENTIONS

OVERVIEW

The new graphical display on each control panel allows a wide variety of information to be presented to the user. Each screen description in this document will begin with a section entitled **Overview** which will describe the graphical elements on the screen and give a short summary of the functions available. Each element on the screen will then be categorized into three distinct groups: Display Only, Programmable and Navigation. Below is a short description of what types of information are included in these groups.

The Programmable values and Navigation commands are also subject to access level restrictions as described below. For each of these elements, an indication is given to show the minimum access level required to program the value or navigate to the subscreen.

DISPLAY ONLY

Values in this group are read-only parameters of information about the chiller operation. This type of information may be represented by a numerical value, a text string or an LED image. For numerical values, if the monitored parameter is above the normal operating range, the high limit value will be displayed along with the '>' symbol; if it is below the normal operating range, the low limit value will be displayed along with the '<' symbol. In some cases, the value may be rendered invalid by other conditions and the display will use X's to indicate this.

PROGRAMMABLE

Values in this group are available for change by the user. In order to program any setpoints on the system, the user must first be logged in with the appropriate access level. Each of the programmable values requires a specific Access Level which will be indicated beside the specified value. All of the programmable controls in the system fall into one of the categories described below:

Access Level

In order to program any setpoints on the system, the user must first login with an appropriate access level. When power is applied to the chiller, the system begins with an Access Level of **VIEW**. This will allow the user to navi-

gate to most screens and observe the values displayed there. However, the user will not be allowed to change any values. To change any values, the user must return to the **Home Screen** (shown by default when power is applied to the system) and use the **LOGIN** button or utilize the **CHANGE SETPOINTS** key described below. At this point, the user will be prompted to enter a User ID and the corresponding Password. By default, the User ID is zero (0). In order to gain standard **OPERATOR** level access, the Password would be entered as **9 6 7 5**, using the numeric keypad. **OPERATOR** access reverts to the **VIEW** level after 10 continuous minutes without a keypress. If a custom User ID and Password have been defined (see User Screen), the user may enter that User ID and the corresponding Password value.

If the correct password is received, the user is authorized with the appropriate Access Level. If an incorrect password is entered, the user is notified of the failure and prompted again. At this point the user may retry the password entry or cancel the login attempt.

Change Setpoints

On screens containing setpoints programmable at the **OPERATOR** access level, a key with this label will be visible if the present access level is **VIEW**. This key brings up the Access Level prompt described above. It allows the user to login at a higher Access Level without returning to the Home Screen. After login, the user may then modify setpoints on that screen.

Setpoints

The control center uses the setpoint values to control the chiller and other devices connected to the chiller system. Setpoints can fall into several categories. They could be numeric values (such as 45.0°F for the Leaving Chilled Liquid Temperature) or they could Enable or Disable a feature or function.

Regardless of which setpoint is being programmed, the following procedure applies:

1. Press the desired setpoint key. A dialog box appears displaying the present value, the upper and lower limits of the programmable range and the default value.
2. If the dialog box begins with the word "ENTER", use the numeric keys to enter the desired value.

Leading zeroes are not necessary. If a decimal point is necessary, press the ‘.’ key (i.e. 45.0).

Pressing the ▲ key, sets the entry value to the default for that setpoint. Pressing the ▼ key, clears the present entry. The ◀ key is a backspace key and causes the entry point to move back one space.

If the dialog box begins with “SELECT”, use the ◀ and ▶ keys to select the desired value.

If the previously defined setpoint is desired, press the ‘X’ (Cancel) key to dismiss the dialog box.

3. Press the ‘✓’ (Enter) key.

If the value is within range, it is accepted and the dialog box disappears. The chiller will begin to operate based on the new programmed value. If out of range, the value will not be accepted and the user is prompted to try again.

Manual Controls

Some keys are used to perform manual control functions. These may involve manual control of items such as the pre-rotation vanes, variable orifice (future) or hot gas bypass valve. Other keys in this category are used to initiate/terminate processes such as calibrations or reports.

Free Cursor

On screens containing many setpoints, a specific “soft” key may not be assigned to each setpoint value. A soft key will be assigned to enable the cursor arrow keys below the numeric keypad which are used to “highlight” the desired setpoint field. At this point, the ‘✓’ key is pressed to bring up a dialog prompting the user to enter a new setpoint value. The ‘X’ key cancels cursor mode. (See the Schedule Screen [Fig. 24] for an example.)

NAVIGATION

In order to maximize the amount of values which the panel can display to the user and in order to place those values in context, multiple screens have been designed to describe the chiller operation. In order to move from one screen to the next, navigation keys have been defined. These keys allow the user to either move “forward” to a subscreen of the present screen or move “backward” to the previous screen. Except for the Home Screen display, the upper-right “soft” key will always return the user to the Home Screen. Navigating with “soft” keys is as simple as pressing the key next to the label containing the name of the desired screen. The system will immediately refresh the display with the graphics for that screen. Following is a layout of all the screens and how they are connected.

Home Screen (page 14)

System Screen (page 16)

└─ Evaporator (page 18)

└─ Condenser (page 20)

└─ Purge (page 22)

└─ Refrig. Level Control (page 24)

└─ Compressor (page 26)

└─ Hot Gas Bypass (page 28)

└─ Surge Protection Screen (page 30)

└─ Vane Calibration (page 32)

└─ VSD Tuning (page 34)

└─ Oil Sump (page 36)

└─ Motor (page 37)

└─ EM Starter Version (page 37)

└─ Mod “A” Solid State Starter (page 38)

└─ Mod “B” Solid State Starter (page 40)

└─ VSD Version (page 42)

└─ VSD Details (page 44)

└─ ACC Details (page 48)

└─ Harmonic Filter Details (page 50)

└─ Setpoints (page 54)

└─ Setup (page 56)

└─ Schedule (page 58)

└─ User (page 60)

└─ Comms (page 62)

└─ Printer (page 64)

└─ Sales Order (page 66)

└─ Operations (page 68)

└─ Diagnostics (*Refer to YORK*

└─ *Service Manual 160.55-M1*)

└─ History (page 70)

└─ History Details (page 72)

└─ Security Log (page 73)

└─ Security Log Details (page 74)

└─ Trend (page 76)

└─ Trend Setup (page 78)

└─ Advanced Trend Setup (page 80)

└─ Common Slots (page 82)

└─ Custom View (page 83)

└─ Custom Setup (page 84)

LANGUAGES

The Screens can be displayed in various languages. Language selection is done on the USER Screen. The desired language is selected from those available. Not all languages

are available. English is the default language. If a language other than English is being displayed, an English-only speaking person should navigate to the USER Screen using the preceding Navigation chart and select English per the USER Screen instructions in this book.

ANALOG INPUT RANGES

The following table indicates the valid display range for each of the analog input values. In the event that the input sensor is reading a value outside of these ranges, the < or > symbols will be displayed beside the minimum or maximum value, respectively.

ANALOG INPUT	ENGLISH RANGE			METRIC RANGE		
	LOW	HIGH	UNITS	LOW	HIGH	UNITS
Leaving Chilled Liquid Temperature	0.0	82.0	°F	-17.7	27.7	°C
Return Chilled Liquid Temperature	0.0	94.1	°F	-17.7	34.5	°C
Leaving Condenser Liquid Temperature	8.0	133.5	°F	-13.3	56.3	°C
Return Condenser Liquid Temperature	8.0	133.5	°F	-13.3	56.3	°C
Evaporator Refrigerant Temperature	0.0	126.1	°F	-17.7	52.3	°C
Discharge Temperature	19.0	226.3	°F	-7.2	107.9	°C
Oil Temperature	19.0	226.3	°F	-7.2	107.9	°C
Condenser Pressure	2.5	35.3	PSIA	17.2	243.4	KPAA
Condenser Temperature (R11)*	-1.4	124.2	°F	-18.5	51.2	°C
Condenser Temperature (R123)*	7.2	130.1	°F	-13.7	54.5	°C
Evaporator Pressure	0.0	12.5	PSIA	6.9	86.2	KPAA
Evaporator Temperature (R11)*	-31.2	66.8	°F	-35.7	19.3	°C
Evaporator Temperature (R123)*	-22.4	74.2	°F	-30.2	23.4	°C
Oil Sump Pressure	2.9	20.9	PSIA	20.0	144.1	KPAA
Oil Pump Pressure	14.3	78.2	PSIA	98.6	539.2	KPAA
Purge Pressure	0.0	100.0	PSIA	6.9	689.5	KPAA
Refrigerant Level (Future)	0.0	100.0	%	0.0	100.0	%
Drop Leg Refrigerant Temperature	0.0	121.8	°F	-17.7	49.8	°C

*Saturation temperatures are calculated values. They will display XXX if the pressure used for the calculation is out of range.

HOME SCREEN



FIG. 4

00347VIP

OVERVIEW

When the chiller system is powered on, the above default display appears. The primary values which must be monitored and controlled are shown on this screen. The Home Screen display depicts a visual representation of the chiller itself. Animation indicates chilled liquid flow.

DISPLAY ONLY**Chilled Liquid Temperature - Leaving**

Displays the temperature of the liquid as it leaves the evaporator.

Chilled Liquid Temperature - Return

Displays the temperature of the liquid as it enters the evaporator.

Condenser Liquid Temperature - Leaving

Displays the temperature of the liquid as it leaves the condenser.

Condenser Liquid Temperature - Return

Displays the temperature of the liquid as it enters the condenser.

Motor Run (LED)

Is **ON** when the digital output controlling the Motor Starter contact is on.

Input Power (kW)

Available only if the chiller system is utilizing a Variable Speed Drive motor controller or Mod "B" Solid State Starter. This displays the total input power used by the system.

% Full Load Amps

This displays the percentage of full load amps utilized by the system.

Operating Hours

Displays the cumulative operating hours of the chiller.

PROGRAMMABLE**Login**

Access Level Required: VIEW

The Control Center restricts certain operations based on password entry by the operator. Three different access levels are provided as follows: **VIEW**: The panel defaults to the lowest access level which is termed **VIEW**. In this mode, the chiller operating values and setpoints can be observed, but no changes can be made. **OPERATOR**: The second access level is termed **OPERATOR** and will allow the customer to change all of the setpoints required to operate the chiller system. The **OPERATOR** access level reverts to the **VIEW** level after 10 continuous minutes without a keypress. **SERVICE**: In the event that advanced diagnostics are necessary, a **SERVICE** access level has been provided.

Only qualified service personnel utilize this access level. This level provides advanced control over many of the chiller functions and allows calibration of many of the chiller controls. The access levels are listed above in hierarchical order beginning with the lowest level and proceeding to the highest level. Users logged in under higher access levels may perform any actions permitted by lower access levels.

The **OPERATOR** access level is accompanied by a 10-minute timeout. After ten (10) successive minutes without a keypress, the panel will revert to the **VIEW** access level. This prevents unauthorized changes to the chiller if a user was logged in at a higher access level and failed to logout. Proper procedure requires that after making necessary setpoint adjustments the user return to the Home Screen and logout.

Logout

Access Level Required: OPERATOR

This key is displayed when a user is logged in at any level other than **VIEW**. Pressing it will return the access level to **VIEW**.

Print

Access Level Required: VIEW

Use this key to generate a hard-copy report of the present system status. This provides a snapshot of the primary operating conditions at the time the key is pressed. The History page provides enhanced reporting capability. (See HISTORY below.) This option will not be present if the chiller is presently configured to log any incoming Adaptive Capacity Control map points. (See the Adaptive Capacity Control Details screen.)

Message Clear

Access Level Required: SERVICE

When certain safety or cycling conditions have been detected and the chiller has been shutdown, the main status display of the chiller will continue to display a message indicating the cause of the shutdown. Using this key, the message can be cleared once the condition has been removed.

Warning Reset

Access Level Required: OPERATOR

Use of this key acknowledges a warning condition and resets the message display associated with it.

NAVIGATION

System

Used to provide additional system information.

Evaporator

A detailed view of all evaporator parameters, including the programmable Leaving Chilled Liquid Setpoints.

Condenser

A detailed view of all condenser parameters, including control of the purge functions.

Compressor

A detailed view of all the compressor parameters. This includes pre-rotation vane control, Hot Gas Bypass Control and PRV calibration.

Oil Sump

A detailed view of all the oil pump and oil sump parameters.

Motor

A detailed view of the motor controller parameters, specific to the controller type presently utilized on the chiller system. This allows programming of the Current Limit and the Pulldown Demand Limit values. For a VSD system, the Adaptive Capacity Control and Harmonic Filter information is controlled under this screen.

Setpoints

This screen provides a single location to program the most common system setpoints. It is also the gateway to many of the general system setup parameters such as Date/Time, Display Units, Scheduling, Printer Setup, etc.

History

This screen provides access to a snapshot of system data at each of the last 10 shutdown conditions.

SYSTEM SCREEN

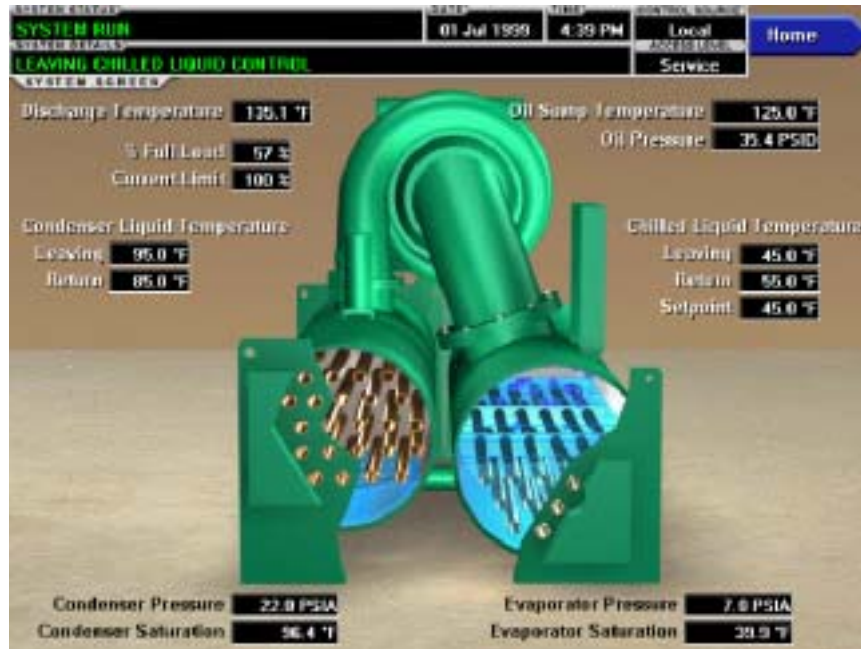

FIG. 5

00348VIP

OVERVIEW

This screen gives a general overview of common chiller parameters for both shells.

DISPLAY ONLY

Discharge Temperature

Displays the temperature of the refrigerant in its gaseous state at discharge of the compressor as it travels to the condenser.

Chilled Liquid Temperature - Leaving

Displays the temperature of the liquid as it leaves the evaporator.

Chilled Liquid Temperature - Return

Displays the temperature of the liquid as it enters the evaporator.

Chilled Liquid Temperature - Setpoint

Displays the active temperature setpoint to which the chiller is controlling the evaporator liquid. This value could come from a 0-20mA or 4-20mA, 0-10VDC or 2-10VDC input in Analog Remote mode, PWM signal in Digital Remote mode, MicroGateway interface in ISN mode or a locally programmed value in local mode.

Evaporator Pressure

Displays the present refrigerant pressure in the evaporator.

Evaporator Saturation Temperature

Displays the present saturation temperature in the evaporator.

Condenser Liquid Temperature - Leaving

Displays the temperature of the liquid as it leaves the condenser.

Condenser Liquid Temperature - Return

Displays the temperature of the liquid as it enters the condenser.

Condenser Pressure

Displays the refrigerant pressure in the condenser.

Condenser Saturation Temperature

Displays the saturation temperature in the condenser.

Oil Sump Temperature

Displays the temperature of the oil in the sump.

Oil Pressure

Displays the pressure differential between the pump oil pressure transducer and the sump oil pressure transducer. If either of the transducers used to calculate this differential is out of range, the display field will show XX.X.

% Full Load Amps

This displays the percentage of full load amps utilized by the system.

Current Limit

Displays the current limit value in use. This value could come from a 0-20mA or 4-20mA, 0-10VDC or 2-10VDC input in Analog Remote mode, PWM signal in Digital Remote mode, MicroGateway interface in ISN mode or a locally programmed value.

PROGRAMMABLE

None

NAVIGATION**Home**

Access Level Required: VIEW

Causes an instant return to the Home Screen.

EVAPORATOR SCREEN



FIG. 6

00349VIP

OVERVIEW

This screen displays a cutaway view of the chiller evaporator. All setpoints relating to the evaporator side of the chiller are maintained on this screen. Animation of the evaporation process indicates whether the chiller is presently in a **RUN** condition. Animation of the liquid flow indicates chilled liquid flow.

DISPLAY ONLY

Chilled Liquid Flow Switch (Open / Closed)

Displays whether the liquid flow is present in the evaporator.

Chilled Liquid Pump

Displays the command presently sent by the control center to the Chilled Liquid Pump (**RUN** or **STOP**).

Evaporator Pressure

Displays the present refrigerant pressure in the evaporator.

Evaporator Saturation Temperature

Displays the present saturation temperature in the evaporator.

Return Chilled Liquid Temperature

Displays the temperature of the liquid as it enters the evaporator.

Leaving Chilled Liquid Temperature

Displays the temperature of the liquid as it leaves the evaporator.

Evaporator Refrigerant Temperature

Displays the temperature of the refrigerant in the evaporator, if the sensor is present.

Small Temperature Difference

Displays the difference between the Leaving Chilled Liquid temperature and the Evaporator Refrigerant temperature. The Evaporator Refrigerant temperature will be represented by the Refrigerant Temperature sensor input if the sensor is present, otherwise it will be represented by the Evaporator Saturation temperature.

Leaving Chilled Liquid Temperature Setpoints – Setpoint

Displays the present setpoint to which the chiller is operating, whether controlled locally or remotely.

Leaving Chilled Liquid Temperature Setpoints – Shutdown

Displays the Leaving Chilled Liquid Temperature at which the chiller will shut down to avoid over-cooling the building. By default this value is 4°F below the Leaving Chilled Setpoint.

Leaving Chilled Liquid Temperature Setpoints – Restart

Displays the Leaving Chilled Liquid Temperature at which the chiller will restart after it has shut down due to over-cooling temperature. By default, the chiller will restart at the Leaving Chilled Liquid Temperature Setpoint.

PROGRAMMABLE

Local Leaving Chilled Liquid Temperature - Range *Access Level Required: OPERATOR*

This is the range over which an analog (0-20mA or 4-20mA, 0-10VDC or 2-10VDC) in Analog Remote Mode or a digital signal (PWM) in Digital remote mode can reset the Leaving Chilled Liquid Temperature setpoint above the operator programmed **Base** Setpoint (see below). Programmable as either 10°F or 20°F, with a default of 20°F, it is added to the **Base** value to create a range over which the remote device can reset the setpoint. For example, if this setpoint is programmed for 10°F and the operator programmed value is 45°F, then the remote device can set the Leaving Chilled Liquid Temperature setpoint over the range 45.0° - 55.0°F.

Local Leaving Chilled Liquid Temperature - Setpoint

Access Level Required: OPERATOR

This value allows the user to define the Leaving Chilled Liquid Temperature that is to be maintained by the chiller. It is programmable over the range of 38.0°F to 70.0°F (water) or 10.0°F to 70.0°F (brine). If Smart Freeze (see below) is enabled, the range is 36.0°F to 70.0°F (water). A remote device can provide an analog signal (0-20mA or 4-20mA, 0-10VDC or 2-10VDC) in Analog Remote mode or PWM signal in Digital Remote mode that changes the setpoint by creating an offset above the operator programmed **Base** Leaving Chilled Liquid Temperature setpoint. This offset may be defined up to 10.0°F or 20.0°F above the **Base** setpoint (see the Remote Leaving Chilled Liquid Temperature Setpoint Range description above). Additionally, a MicroGateway (in ISN Remote mode) can define the setpoint through a serial data stream. In this case, the incoming setpoint is not an offset that is applied to the locally programmed **Base** setpoint value, but rather is the setpoint value itself.

Leaving Chilled Liquid Temperature Cycling Offset - Shutdown

Access Level Required: OPERATOR

This value allows the user to specify the Leaving Chilled Liquid Temperature at which the chiller will shut down on a **LEAVING CHILLED LIQUID – LOW TEMPERATURE** cycling shutdown. This is done by defining an offset below the Leaving Chilled Liquid Temperature setpoint. It is programmable over a range of 1°F to 64°F below the setpoint, to a minimum cutout of 36°F (water), 34°F (water with Smart Freeze enabled) or 6°F (brine). It establishes the minimum allowable temperature for the Leaving Chilled Liquid Temperature and prevents overcooling of the building. Anytime the Leaving Chilled Liquid Temperature setpoint is increased, the shutdown

threshold is 36.0°F (water) or 6.0°F (brine) for the next ten (10) minutes. If Smart Freeze (see below) is enabled, the threshold is 34.0°F for the next 10 minutes. After ten (10) minutes have elapsed, the shutdown threshold becomes the programmed setpoint value.

Leaving Chilled Liquid Temperature Cycling Offset - Restart

Access Level Required: OPERATOR

This value allows the user to specify the Leaving Chilled Liquid Temperature at which the chiller will restart after a shutdown on a **LEAVING CHILLED LIQUID – LOW TEMPERATURE** cycling shutdown. This is done by defining an offset above the Leaving Chilled Liquid Temperature setpoint. It is programmable over a range of 0°F to 70°F above the setpoint, to a maximum restart value of 80°F. The chiller will automatically restart when this temperature is reached. This setpoint can be used to reduce chiller cycling by delaying the chiller restart until the cooling load has increased.

Brine Low Evaporator Cutout

Access Level Required: SERVICE

This value is only available in Brine mode. It allows the user to specify the Evaporator Pressure at which a safety shutdown is initiated. Service Technicians refer to YORK Service Manual 160.55-M1.

Sensitivity

Access Level Required: SERVICE

This value allows the user to adjust the sensitivity of the Leaving Chilled Liquid Temperature control. Service Technicians refer to YORK Service Manual 160.55-M1.

Smart Freeze (Off / On)

Access Level Required: SERVICE

This value is only available if the chiller is not in Brine mode. It allows the user to enable the Smart Freeze Point Operation which allows the chiller to run closer to the freeze point without shutting down. Service Technicians refer to YORK Service Manual 160.55-M1.

Refrigerant (Enabled / Disabled)

Access Level Required: SERVICE

When an Evaporator Refrigerant Sensor has been installed it must be enabled via this toggle before the system will utilize the new, enhanced resolution input. Service Technicians refer to YORK Service Manual 160.55-M1.

NAVIGATION

Home

Access Level Required: VIEW

Causes an instant return to the Home Screen.

CONDENSER SCREEN

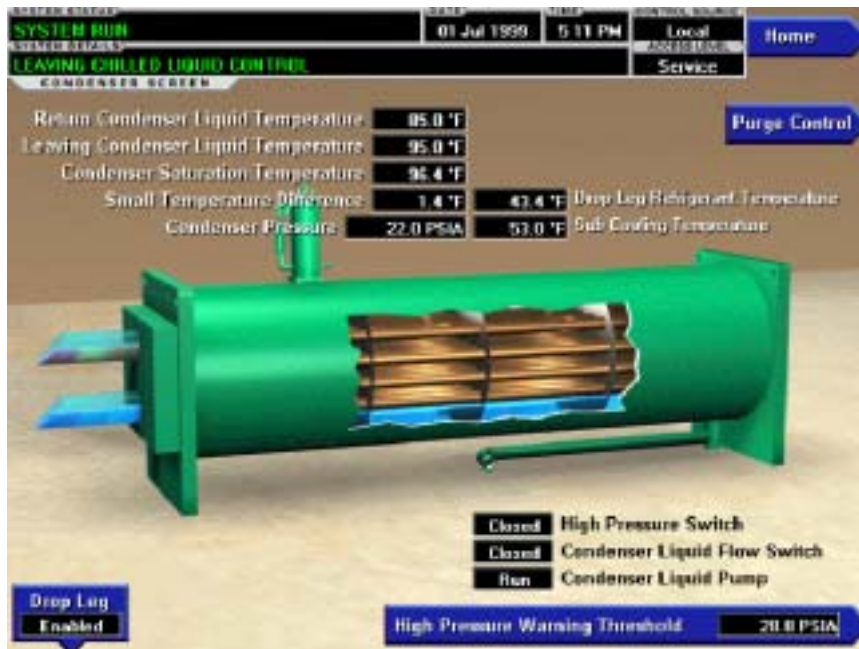

FIG. 7

00350VIP0

OVERVIEW

This screen displays a cutaway view of the chiller condenser. All setpoints relating to the condenser side of the chiller are maintained on this screen. Animation indicates condenser liquid flow. This screen also serves as a gateway to controlling the Refrigerant Level.

DISPLAY ONLY

Leaving Condenser Liquid Temperature

Displays the water temperature as it leaves the condenser.

Return Condenser Liquid Temperature

Displays the water temperature as it enters the condenser.

Condenser Pressure

Displays the refrigerant pressure in the condenser.

Condenser Saturation Temperature

Displays the saturation temperature in the condenser.

Small Temperature Difference

Displays the difference between the Condenser Refrigerant temperature and the Leaving Condenser Liquid temperature. The Condenser Refrigerant temperature will be represented by the Condenser Saturation temperature.

Drop Leg Refrigerant Temperature

Displays the temperature of the refrigerant in the drop leg between the condenser and evaporator shells, if the sensor is present.

Sub-Cooling Temperature

Displays the difference between the Condenser Refrigerant temperature and the Drop Leg Refrigerant temperature. The Condenser Refrigerant temperature will be represented by the Condenser Saturation temperature. If the Drop Leg sensor is not present, this temperature is not displayed.

High Pressure Switch (Open / Closed)

Displays the present position of the high pressure switch. This will indicate whether a High Pressure fault is present.

Condenser Liquid Flow Switch

Indicates whether flow is present in the condenser.

Condenser Liquid Pump (Run / Stop)

Indicates whether Condenser liquid pump is operating.

Refrigerant Level Position

Displays the present position of the refrigerant level if this function is enabled.

Refrigerant Level Setpoint

Displays the setpoint to which the refrigerant level is being controlled.

Ramp Up Time Remaining

Displays the time remaining in the period in which the Refrigerant Level Setpoint is being ramped to the Refrigerant Level Target Setpoint. This only displayed if the Refrigerant Ramp is in effect and the value is non-zero. Service Technicians refer to YORK Service Manual 160.55-M1.

PROGRAMMABLE**High Pressure Warning Threshold**

Access Level Required: SERVICE

This value allows the user to define the condenser pressure at which the chiller will initiate a warning.

Drop Leg (Enabled / Disabled)

Access Level Required: SERVICE

When a Drop Leg Refrigerant Sensor has been installed

it must be enabled via this toggle before the system will utilize the new, enhanced resolution input. Service Technicians refer to YORK Service Manual 160.55-M1.

NAVIGATION**Home**

Access Level Required: VIEW

Causes an instant return to the Home Screen.

Purge

Access Level Required: VIEW

Moves to the subscreen allowing programming of the Purge System Setpoints.

Refrigerant Level Control

Access Level Required: SERVICE

Moves to the sub-screen allowing programming of the Refrigerant Level control setpoints.

PURGE SCREEN

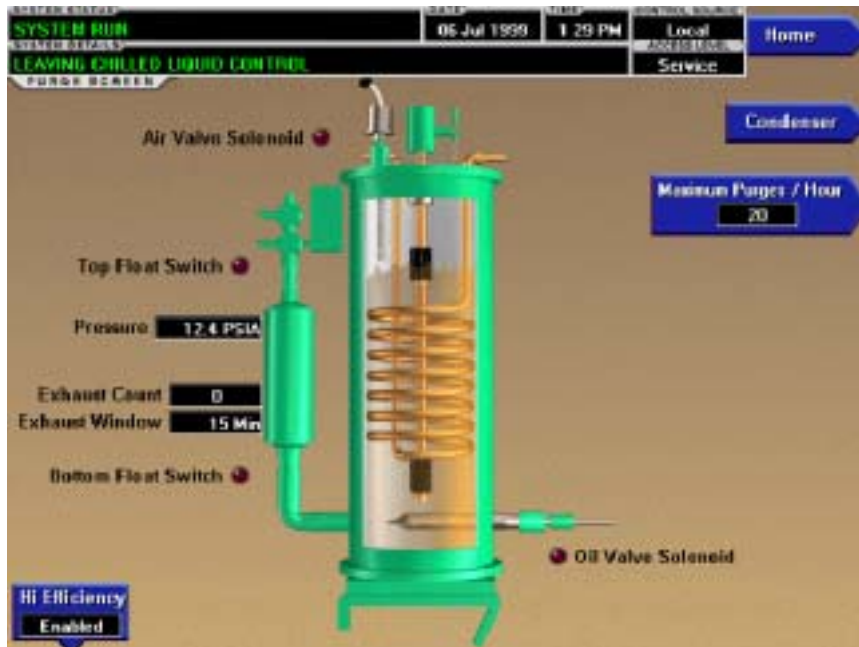

FIG. 8

00351VIP

OVERVIEW

This screen displays a cutaway view of the Purge Tank. LED's depict the state of the Float switches, Oil Valve solenoid and Air Valve solenoid and the purge exhaust count is displayed. All setpoints relating to the purge system are maintained on this screen. The Purge tank oil level, based on the position of the float switches, is depicted through animation. When both the Float Switches are closed, the oil level is shown at its lowest (empty) level. When both Float switches are open, the level is shown at its highest (full) level. Levels between these extremes are shown at midpoint.

DISPLAY ONLY

Air Valve Solenoid (LED)

Illuminated when the Air Valve Solenoid is energized (open), venting non-condensibles from the Purge tank. Otherwise, extinguished. For High Efficiency (pump assisted) purge systems, the valve is energized at >90.0 PSIA and de-energizes when the pressure decreases to <80.0 PSIA. For non-assisted purge systems, the valve is energized at >34.7 PSIA and de-energized when the pressure decreases to <29.7 PSIA.

Top Float Switch (LED)

Illuminated when the Top Float Switch is closed, indicating the Purge Tank oil level is less than full.

Extinguished when it is open, indicating the level is at maximum (full).

Bottom Float Switch (LED)

Illuminated when the Bottom Float Switch is closed, indicating the Purge Tank oil level is at minimum (empty). Extinguished when it is open, indicating the oil level is above minimum.

Oil Valve Solenoid (LED)

Illuminated when the Oil Valve Solenoid is energized, filling the Purge Tank with oil. Extinguished when it is de-energized, draining the oil from the Purge tank.

Pressure

Displays the pressure in the Purge Tank.

Exhaust Count

Displays the number of purge exhausts that have occurred within the last 0 to 60 minutes, as displayed in the Exhaust Window. After a 60 minute bypass at chiller start, purge exhausts are counted until the Excess Purge threshold is reached or the chiller shuts down, whereupon the count is frozen. The count will be reset when the chiller starts.

Exhaust Window

Displayed as 0 to 60 minutes. After a 60 minute bypass at chiller start, the Exhaust Window increments from 0

to 60. During this period, purge exhausts are counted and the Exhaust Count displayed is that which has occurred in the last number of minutes displayed in the Exhaust Window. After the Exhaust Window reaches 60, the purge exhausts that occurred in the oldest minute are discarded from the Exhaust Count and exhausts from the most recent minute are shifted in, providing a rolling count of purge exhausts that occurred in the last 60 minutes. It remains at 60 until the chiller is restarted, whereupon it is reset to 0.

Bypass Time Left

Replaces “Exhaust Window” label during the first 60 minutes of chiller run. Counts down the 60 minute purge count bypass.

PROGRAMMABLE

High Efficiency Purge System (Enabled/Disabled)

Access Level Required: SERVICE

Selects the appropriate control and purge exhaust thresholds for the installed purge system. High Efficiency (pump assisted) purge systems exhaust at >90.0

PSIA. Non pump-assisted purge systems exhaust at >34.7 PSIA.

Maximum Purges/Hour

Access Level Required: OPERATOR/SERVICE

Allows the user to define the number of purge air exhausts permitted before an Excess Purge Warning is displayed. With OPERATOR access level, the value can be programmed over a range of 10 to 30 Purges/Hour. Service Technicians, in SERVICE access level can program this setpoint over a greater range. Service Technicians refer to YORK Service Manual 160.55-M1.

NAVIGATION

Home

Access Level Required: VIEW

Causes an instant return to the Home Screen.

Condenser

Access Level Required: VIEW

Causes an instant return to the Condenser Screen.

REFRIGERANT LEVEL CONTROL SCREEN

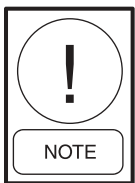

FIG. 9

00303VIP

OVERVIEW

This screen displays a cutaway view of the chiller condenser, along with the liquid refrigerant level sensor and the flow control valve. All setpoints relating to the liquid level control are maintained on this screen. Through animation, the variable orifice position is displayed. In addition, the refrigerant flow control valve (variable orifice) can be manually operated.



*Requires a login access level of **SERVICE**. Service Technicians refer to YORK Service Manual 160.55-M1 for operation instructions and explanation of all programmable setpoints and displayed values.*

DISPLAY ONLY**Refrigerant Level Position**

Displays the present position of the liquid level. The refrigerant level is animated in the cutaway view of the condenser. When the actual level is 0% to 15%, the level is shown about 50% full. When the actual level is 16% to 31%, the level is shown about 60% full. When the actual level is 32% to 47%, the level is shown about 70% full. When the actual level is 48% to 63%, the level is shown about 80% full. When the actual level is 64% to 79%, the level is shown as about 90% full. Actual levels above 79%, shown as 100% full.

Refrigerant Level Control Mode

Indicates whether the liquid level control is under manual or automatic control.

Raise (LED)

Is ON when the digital output controlling the Level Raise contact is on.

Lower (LED)

Is ON when the digital output controlling the Level Lower contact is on.

PROGRAMMABLE**[Refrigerant Level] Setpoint**

Service Technicians refer to YORK Service Manual 160.55-M1.

[Refrigerant Level Control] Period

Service Technicians refer to YORK Service Manual 160.55-M1.

[Refrigerant Level Control] Proportional Limit Open

Service Technicians refer to YORK Service Manual 160.55-M1.

[Refrigerant Level Control] Proportional Limit Close

Service Technicians refer to YORK Service Manual 160.55-M1.

[Refrigerant Level Control] Rate Limit Open

Service Technicians refer to YORK Service Manual 160.55-M1.

[Refrigerant Level Control] Rate Limit Close

Service Technicians refer to YORK Service Manual 160.55-M1.

[Refrigerant Level Control] Raise (Manual)

This key puts the level control into manual mode and sends a **RAISE** command to the variable orifice.

[Refrigerant Level Control] Lower (Manual)

This key puts the level control into manual mode and sends a **LOWER** command to the variable orifice.

[Refrigerant Level Control] Hold (Manual)

This key puts the level control into manual mode and sends a **HOLD** command to the variable orifice.

[Refrigerant Level Control] Auto

Returns the Level Control to automatic mode.

NAVIGATION

Home

Access Level Required: VIEW

Causes an instant return to the Home Screen.

Condenser

Access Level Required: VIEW

Return to the Condenser Screen.

COMPRESSOR SCREEN

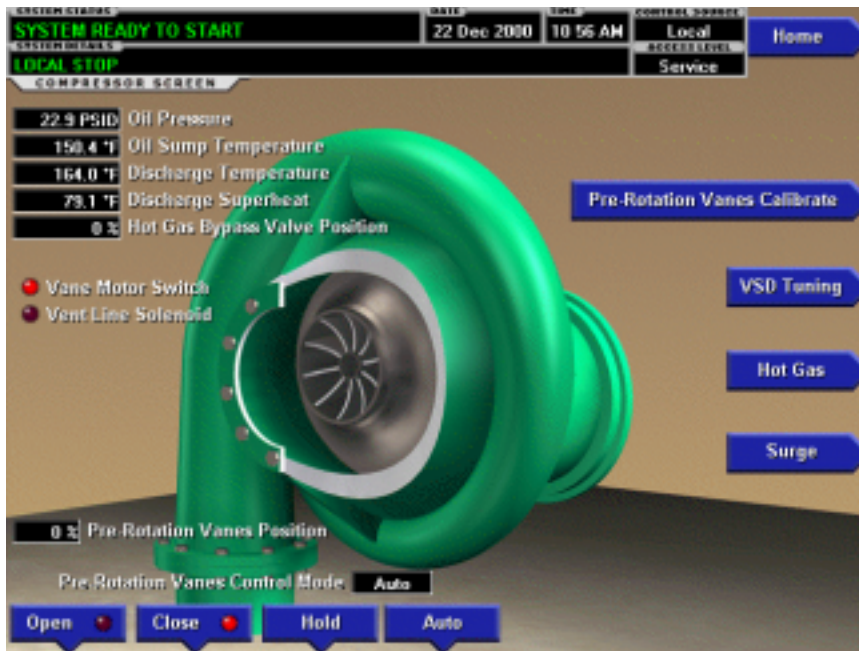

FIG. 10

00483VIP

OVERVIEW

This screen displays a cutaway view of the chiller compressor, revealing the impeller and shows all conditions associated with the compressor. In addition, with the proper Access Level, the pre-rotation vanes may be manually controlled. Animation of the compressor impeller indicates whether the chiller is presently in a **RUN** condition. This screen also serves as a gateway to subscreens for calibrating the pre-rotation vanes, calibrating the proximity probe, configuring the Hot Gas Bypass or providing advanced control of the compressor motor Variable Speed Drive.

DISPLAY ONLY

Oil Pressure

Displays the pressure differential between the high side oil pressure transducer (compressor bearing input) and the low side oil pressure transducer (oil sump). If either of the transducers used to calculate this differential is out of range, the display field will show XX.X.

Oil Sump Temperature

Displays the temperature of the oil in the sump

Discharge Temperature

Displays the temperature of the refrigerant in its gaseous state at discharge of the compressor as it travels to the condenser.

Superheat Temperature

Displays the discharge superheat temperature, calculated as (Discharge temperature – Condenser Saturated temperature).

Vane Motor Switch (LED)

Illuminates when the vanes are completely closed.

Vent Line Solenoid (LED)

Illuminates when the solenoid is energized.

Pre-Rotation Vanes Control Mode

Access Level Required: SERVICE

Indicates whether the vanes are under manual or automatic control.

[Pre-Rotation Vanes] Open (LED)

Access Level Required: SERVICE

Indicates whether the vanes are in the process of opening.

[Pre-Rotation Vanes] Close (LED)

Access Level Required: SERVICE

Indicates whether the vanes are in the process of closing.

Pre-Rotation Vanes Position (Variable Speed Drive only)

Access Level Required: SERVICE

This value displays the present position of the pre-rotation vanes as a percentage between 0 and 100%.

Full Load Amps

Access Level Required: SERVICE

Displays the motor current as a percentage of the Full Load Amps (FLA) value.

Phase A, B, C Current (Solid State Starter only)

Access Level Required: SERVICE

Displays the 3-phase motor current values being read from the Solid State Starter.

PROGRAMMABLE**[Pre-Rotation Vanes] Open (Manual)**

Access Level Required: SERVICE

This key puts the vane control into manual mode and sends an **OPEN** command to the vanes.

[Pre-Rotation Vanes] Close (Manual)

Access Level Required: SERVICE

This key puts the vane control into manual mode and sends a **CLOSE** command to the vanes.

[Pre-Rotation Vanes] Hold (Manual)

Access Level Required: SERVICE

This key puts the vane control into manual mode and sends a **HOLD** command to the vanes.

[Pre-Rotation Vanes] Auto

Access Level Required: SERVICE

This key returns the vane control to automatic mode.

NAVIGATION**Home**

Access Level Required: VIEW

Causes an instant return to the Home Screen.

Pre-Rotation Vane Calibration

Access Level Required: SERVICE

Only available if the chiller is stopped and the system uses a Variable Speed Drive or Hot Gas Bypass control. Moves to the subscreen allowing calibration of the Pre-rotation vanes. Service Technicians refer to YORK Service Manual 160.55-M1.

VSD TUNING (Variable Speed Drive only)

Access Level Required: SERVICE

Moves to the subscreen allowing advanced tuning of the Variable Speed Drive. Service Technicians refer to YORK Service Manual 160.55-M1.

Hot Gas

Access Level Required: SERVICE

Moves to the subscreen that allows programming of the Hot Gas Bypass control setpoints and manual control of the Hot Gas Bypass valve. Only displayed if Hot gas Bypass feature has been enabled on the OPERATIONS Screen. Service technicians refer to YORK Service Manual 160.55-M1.

Surge

(Flash memory Card version C.MLM.02.02.xxx and later)

Access Level Required: VIEW

Moves to the sub-screen that allows viewing and programming of the Surge Protection feature. Service Technicians refer to Service Manual 160.55-M1.

HOT GAS BYPASS SCREEN

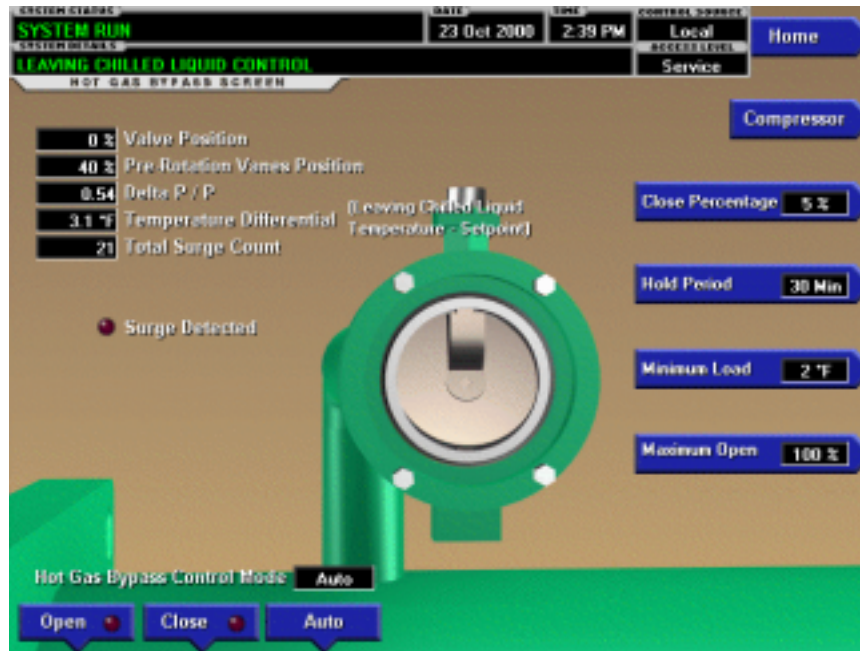
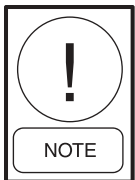

FIG. 11

00476VIP

OVERVIEW

This screen displays a cutaway view of the Hot Gas Bypass Valve. All setpoints relating to Hot Gas Bypass control are maintained on this screen. Also, related Hot Gas Bypass control parameters are displayed for reference. Through animation, the relative valve position is displayed. In addition, the valve can be manually operated.



Requires access level of SERVICE. Service Technicians refer to YORK Service Manual 160.55-M1 for operation instructions and explanation of all programmable setpoints and displayed values.

DISPLAY ONLY**Valve Position**

Displays the position of the Hot Gas valve over the range of 0% (closed) to 100% (fully open). The valve position is animated. When the actual position is 0% to 19%, the valve is shown fully closed. When actual position is 20% to 39% the valve is shown 25% open. When actual position is 40% to 59%, the valve is shown 50% open. When actual position is 60% to 79%, the valve is shown as 75% open. Positions greater than 79% shown as full open.

Pre-rotation Vanes Position

Displays the position of the Pre-Rotation Vanes over the range of 0% (closed) to 100% (fully open). Displayed at XXX until calibration procedure is performed by service technician.

Delta P/P

A parameter that represents system differential or “Head”. It is calculated as [(condenser pressure – evaporator pressure) / evaporator pressure].

Temperature Differential

The difference between the Leaving Chilled Liquid Temperature and the Leaving Chilled Liquid Temperature Setpoint. It is calculated by subtracting the Leaving Chilled Liquid temperature from the Leaving Chilled Liquid Temperature Setpoint.

Total Surge Count

This is the total number of surge events that have been detected over the lifetime of the chiller. These are the surge events detected by the Surge Protection feature. The surge events detected by the compressor Variable Speed Drive Adaptive Capacity Control Board are not included in this total.

Surge Detected (LED)

Illuminated for 5 seconds each time a surge is detected by the Surge Protection feature. It does not illuminate

in response to surge events detected by the compressor Variable Speed Drive Adaptive Capacity Control Board.

Hot Gas Bypass Control Mode

Indicates whether the Hot Gas Bypass is under automatic, manual or override control. “Override” is displayed during Minimum Load override conditions or when the Compressor Motor Variable Speed (if equipped) Drive is running at less than maximum speed.

PROGRAMMABLE

Close Percentage

Service technicians refer to YORK Service Manual 160.55-M1.

Hold Period

Service technicians refer to YORK Service Manual 160.55-M1.

Surge Sensitivity

(Flash Memory Card version C.MLM.02.01.xxx and earlier. On SURGE PROTECTION Screen in later Flash Memory Card versions)

Service technicians refer to YORK Service Manual 160.55-M1.

Minimum Load

Service technicians refer to YORK Service Manual 160.55-M1.

Maximum Open

(Flash Memory Card version C.MLM.02.02.xxx and later)

Service Technicians refer to YORK Service Manual 160.55-M1.

[Hot Gas Bypass Control] Open (Manual)

This key puts the Hot Gas Bypass Control in manual mode and increases the valve position by 5%.

[Hot Gas Bypass Control] Close (Manual)

This key puts the Hot Gas Bypass Control in manual mode and decreases the valve position by 5%.

[Hot Gas Bypass Control] Auto

Returns the Hot Gas Bypass Control to automatic mode.

NAVIGATION

Home

Access Level Required: VIEW

Causes an instant return to the Home Screen.

Compressor

Access Level Required: VIEW

Causes an instant return to the Compressor Screen.

SURGE PROTECTION SCREEN

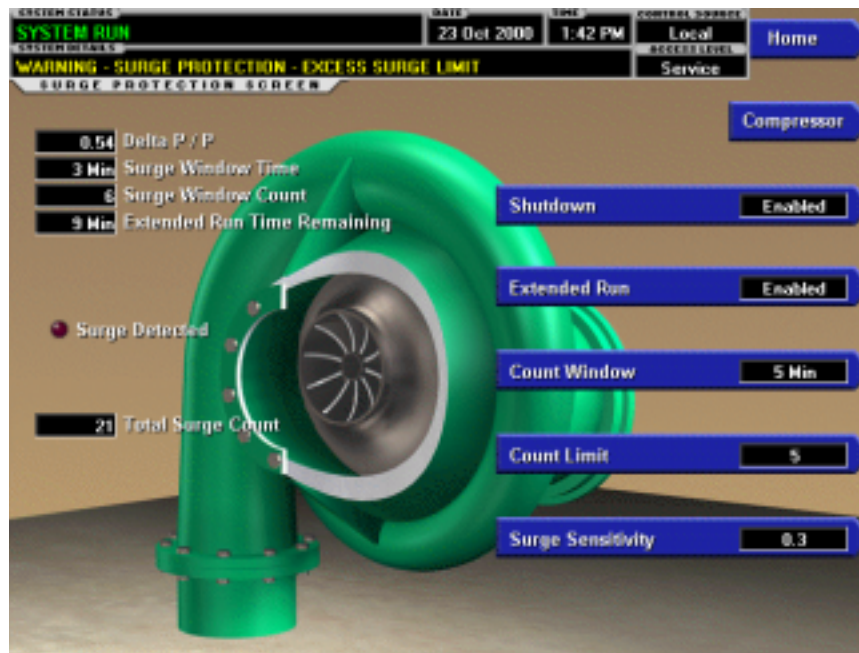

FIG. 12

00482VIP

OVERVIEW

(This feature applies to Flash Memory Card version C.MLM.02.02.xxx and later)

This screen displays a cutaway view of the chiller compressor and all parameters relating to the Surge Protection feature. All setpoints relating to this feature are maintained on this screen.

DISPLAY ONLY

Delta P/P

A parameter that represents the system differential or “Head pressure”. It is calculated as (condenser pressure – evaporator pressure) / evaporator pressure.

Surge Window Time

When the chiller enters run mode, this value counts up to the time programmed as the COUNT WINDOW setpoint. When it reaches the COUNT WINDOW minutes, the number of surge events in the oldest minute is discarded and the number of surge events in the most recent minute is added, thus providing a rolling count of the total surge events that have occurred in the last COUNT WINDOW minutes. This value is reset when the chiller shuts down.

Surge Window Count

Displays the number of surge events that have oc-

curred in the last 1 to 5 minutes as programmed with the COUNT WINDOW setpoint. If the chiller has been running for less than the COUNT WINDOW minutes, it is the number of surge events that have occurred within the last number of minutes displayed as the SURGE WINDOW TIME. The count is cleared when the chiller shuts down.

Surge Detected (LED)

Illuminates for 5 seconds each time a surge is detected by the Surge Protection feature. It does not illuminate in response to surge events detected by the compressor Variable Speed Drive Adaptive Capacity Control Board.

Total Surge Count

Displays the total number of surge events detected over the lifetime of the unit (up to a maximum of 65535). These are the surge events detected by the Surge Protection feature. The surge events detected by the compressor Variable Speed Drive Adaptive Capacity Control Board are not included in this total.

Extended Run Time Remaining

Displays the time remaining in the 10-minute “EXTENDED RUN” period. During this period, the Pre-rotation vanes are driven closed and “Warning – Surge Protection – Excess Surge Limit” is displayed. Refer to operation under “Count Limit” below.

PROGRAMMABLE

Shutdown (Enabled/Disabled)

Access Level Required: OPERATOR

Allows the user to select whether the chiller will shut-down or continue to run when an Excess Surge situation has been detected.

If this setpoint is Enabled and the EXTENDED RUN setpoint is Disabled, a safety shutdown is performed when the SURGE WINDOW COUNT exceeds the COUNT LIMIT setpoint.

If this setpoint is Enabled and the EXTENDED RUN setpoint is Enabled, a safety shutdown is performed if the SURGE WINDOW COUNT exceeds the COUNT LIMIT setpoint at the completion of the 10 minute Extended Run period.

“Surge Protection – Excess Surge” is displayed with either shutdown.

If this setpoint is Disabled, refer to operation under “Count Limit” below.

With Software version C.MLM.02.05.xxx (and later) or C.OPT.02.05.xxx (and later):

- If equipped with a compressor Variable Speed Drive (VSD), the VSD output frequency must be at maximum before the SHUTDOWN feature is implemented or surge warning messages are displayed.
- If equipped with a VSD and Hot Gas Bypass (Enabled), the VSD output frequency must be at maximum AND the Hot Gas Valve must be at 100% before the SHUTDOWN feature is implemented or surge warning messages are displayed.

Extended Run (Enabled/Disabled)

Access Level Required: OPERATOR

Allows the user to select the surge correction/avoidance EXTENDED RUN mode. This will be implemented when an Excess surge situation is detected as follows: Anytime the SURGE WINDOW COUNT exceeds the COUNT LIMIT, the Pre-rotation vanes are driven closed for the next 10 minutes. While this load inhibit is in effect, “Warning – Surge Protection – Excess Surge Limit” is displayed. When 10 minutes have elapsed, the warning message and load inhibit are automatically cleared, provided the SURGE WINDOW COUNT is less than or equal to the COUNT LIMIT. If the SHUTDOWN

setpoint is Enabled, and the SURGE WINDOW COUNT exceeds the COUNT LIMIT at the completion of this period, a safety shutdown is performed and “Surge Protection – Excess Surge” is displayed.

If the Hot Gas Bypassed control is Enabled, the Hot Gas Bypass Valve position must be 100% before the Extended Run mode is implemented. If the chiller is equipped with a compressor motor Variable Speed Drive, output frequency must be at full speed (50 Hz/60 Hz) before the Extended Run mode is implemented. If the chiller is equipped with both Hot Gas Bypass and compressor motor Variable Speed Drive, both of the conditions must be met before Extended Run is implemented.

Count Window

Access Level Required: OPERATOR

Allows the user to define the period of time (1 to 5 minutes; default 5 ; default 3 with Software version C.MLM.02.05.xxx {and later} or C.OPT.02.05.xxx {and later}) in which the number of surge events (SURGE WINDOW COUNT) are compared to the maximum allowed (COUNT LIMIT), for the purpose of detecting an excess surge situation.

Count Limit

Access Level Required: OPERATOR

Allows the user to define the maximum number of surge events (4 to 20; default 4; default 15 with Software version C.MLM.02.05.xxx {and later} or C.OPT.02.05.xxx {and later}) that can occur within a defined period of time before an Excess Surge situation is detected. If the SURGE WINDOW COUNT exceeds the COUNT LIMIT, an Excess Surge situation has occurred.

When an Excess Surge situation is detected, the action depends upon the following:

- If both the SHUTDOWN and EXTENDED RUN setpoints are Disabled, the chiller will continue to run, displaying the message “Warning – Excess Surge detected”. See Hot Gas Bypass and Variable Speed Drive exceptions above.
- If the SHUTDOWN setpoint is Enabled and the EXTENDED RUN setpoint is Disabled, the chiller will perform a safety shutdown and display “Surge Protection – Excess Surge”. See Hot Gas Bypass and Variable Speed Drive exceptions above.
- If the SHUTDOWN setpoint is Disabled and the EXTENDED RUN setpoint is Enabled, the Pre-rotation Vanes are driven closed for 10 minutes and “Warning – Surge Protection – Excess Surge Limit” is displayed. When the 10 minutes have elapsed,

if the SURGE WINDOW COUNT is less than or equal to the COUNT LIMIT, this message and load inhibit are automatically cleared. Alternating with this message is “Warning – Excess Surge Detected” that continues after the 10 minute period has elapsed until manually cleared with the Warning Reset key. See Hot Gas Bypass and Variable Speed Drive exception above.

- If both the SHUTDOWN and EXTENDED RUN setpoint are Enabled, the 10 minute Extended RUN mode is invoked as described above. However, if the SURGE WINDOW COUNT exceeds the COUNT LIMIT at the completion of the 10 minute extended run period, a safety shutdown is performed and “Surge Protection – Excess Surge” is displayed. See Hot Gas Bypass and Variable Speed Drive exception above.

Surge Sensitivity

Access Level Required: SERVICE

Allows the user to define the surge detection sensitivity. Selectable over the range of 0.3 to 1.3; default 0.3. The smaller the number, the greater the sensitivity.

Clear Surge Count

Access Level Required: ADMIN

Allows user to set the Total Surge Count to zero.

NAVIGATION

Home

Access Level Required: VIEW

Causes an instant return to the Home Screen

Compressor

Access Level Required: VIEW

Causes an instant return to the Compressor Screen.

**THIS PAGE INTENTIONALLY LEFT BLANK
TO MAINTAIN FORMAT**

PRE-ROTATION VANES CALIBRATION SCREEN

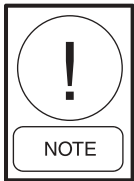

FIG. 13

00354VIP

OVERVIEW

This screen displays a cutaway view of the chiller compressor, revealing the pre-rotation vanes and provides the capability of calibrating the pre-rotation vanes for either Variable Speed Drive or Hot Gas Bypass applications.



Requires a login access level of SERVICE. Service Technicians refer to YORK Service Manual 160.55-M1 for operation instructions and explanation of all programmable setpoints and displayed values.

DISPLAY ONLY

Pre-Rotation Vanes Opening (LED)

Indicates the vanes are opening.

Pre-Rotation Vanes Closing (LED)

Indicates the vanes are closing.

Calibration in Progress (LED)

Indicates the calibration sequence is in progress.

Calibration Messages

These are text messages which step the user through the calibration process and indicate its success or failure.

Hot Gas PRV Voltage

Displays the Pre-rotation Vanes position potentiometer feedback voltage when the Hot Gas Feature is Enabled.

PROGRAMMABLE

Start Calibration

This option is hidden after calibration has started. Service Technicians refer to YORK Service Manual 160.55-M1 for an explanation of this setpoint.

Cancel Calibration

This option only becomes available after calibration has started. Service Technicians refer to YORK Service Manual 160.55-M1 for an explanation of this setpoint.

NAVIGATION

Home

Access Level Required: VIEW

Causes an instant return to the Home Screen.

Compressor

Access Level Required: VIEW

Return to the Compressor Screen.

**THIS PAGE INTENTIONALLY LEFT BLANK
TO MAINTAIN FORMAT**

VSD TUNING SCREEN

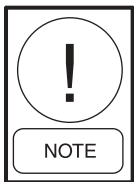

FIG. 14

00477VIP

OVERVIEW

This screen displays a cutaway view of the chiller compressor, revealing the pre-rotation vanes and provides the capability of manually controlling the pre-rotation vanes. Animation of the pre-rotation vanes indicates the pre-rotation vane position. In addition, this screen allows manual control of the frequency command being sent to the Variable Speed Drive.



Requires a login access level of SERVICE. Service Technicians refer to YORK Service Manual 160.55-M1 for operation instructions and explanation of all programmable setpoints and displayed values.

DISPLAY ONLY

Output Frequency

Displays the Output Frequency reported by the Variable Speed Drive.

Temperature Differential

Displays the differential between the Leaving Chilled Liquid Temperature and Setpoint.

Delta P/P

Displays a value based on the pressure differential between the Evaporator and Condenser pressures. $[(\text{Condenser} - \text{Evaporator}) / \text{Evaporator}]$

Pre-Rotation Vanes Control Mode

Indicates whether the vanes are under manual or automatic control.

[Pre-Rotation Vanes] Open (LED)

Indicates whether the vanes are in the process of opening.

[Pre-Rotation Vanes] Close (LED)

Indicates whether the vanes are in the process of closing.

Pre-Rotation Vane Position

This value displays the present position of the pre-rotation vanes as a percentage between 0 and 100%.

[VSD] Command Frequency

Displays the frequency value being sent to the Adaptive Capacity Control.

[VSD] Frequency Control Mode (Manual / Auto)

Displays the present state of the command frequency control.

Output Current – Phase A, B, C
(Flash Memory Card version C.MLM.02.02.xxx
and later)

Displays the phase current measured to the motor.

PROGRAMMABLE

Set

Allows manual programming of the command frequency value. Manually programming this value will put the VSD frequency control into manual mode.

Auto

Following manual programming of the command frequency, this returns the system to automatic control.

Fixed

This key puts the VSD frequency control into fixed speed mode and constantly sends the maximum frequency to the Variable Speed Drive control.

Incr Amount

Defines the amount by which the Increase and Decrease commands will modify the present VSD command frequency.

Increase

This key puts the VSD frequency control into manual mode and increases the present command frequency by the defined frequency increment. It will not raise the value above the maximum allowed frequency.

Decrease

This key puts the VSD frequency control into manual mode and decreases the present command frequency by the defined frequency increment. It will not lower the value below one (1) Hz.

[Pre-Rotation Vanes] Open (Manual)

This key puts the vane control into manual mode and sends an OPEN command to the contacts.

[Pre-Rotation Vanes] Close (Manual)

This key puts the vane control into manual mode and sends a CLOSE command to the contacts.

[Pre-Rotation Vanes] Hold (Manual)

This key puts the vane control into manual mode and sends a HOLD command to the contacts.

[Pre-Rotation Vanes] Auto

Returns Vane Control to automatic mode.

NAVIGATION

Home

Access Level Required: VIEW

Causes an instant return to the Home Screen.

Compressor

Access Level Required: VIEW

Return to the Compressor Screen.

OIL SUMP SCREEN



FIG. 15

00356VIP

OVERVIEW

This screen displays a close-up of the chiller oil sump.

DISPLAY ONLY

Oil Sump Temperature

Displays the temperature of the oil in the sump.

Oil Pressure

Displays the pressure differential between the high side oil pressure transducer (output of oil filter) and the low side oil pressure transducer (compressor housing). If either of the transducers used to calculate this differential is out of range, the display field will show XX.X.

Oil Pump Run Output (LED)

Indicates whether the Oil Pump is being commanded to operate.

Manual Oil Pump Operation Time Left

Displays the time remaining in the 10-minute manual oil pump operation described below.

PROGRAMMABLE

Manual Pump

Access Level Required: OPERATOR

This key puts the Oil Pump control in Manual Mode and forces it to RUN. The Oil Pump is limited to running for a maximum of ten (10) minutes. If a longer running time is desired, this key must be pressed again. Manual Oil Pump control is disabled (and the button hidden) during system prelube, system run and system coastdown.

NAVIGATION

Home

Access Level Required: VIEW

Causes an instant return to the Home Screen.

ELECTRO-MECHANICAL STARTER SCREEN



FIG. 16

00357VIP

OVERVIEW

This screen displays all information pertaining to an Electro-Mechanical Starter.

DISPLAY ONLY

Motor Run (LED)

Indicates whether the digital output from the controls is commanding the motor to **RUN**.

Motor Current % Full Load Amps

Displays the motor current as a percentage of the Full Load Amps (FLA) value. For the Electro-Mechanical Starter this is the data returned by the CM-2 board.

Current Limit Setpoint

Displays the current limit value in use. This value could come from a 0-20mA, 4-20mA, 0-10VDC or 2-10VDC input in Analog Remote mode, PWM signal in Digital Remote mode, MicroGateway interface in ISN mode or a locally programmed value.

Pulldown Demand Time Left

Displays the time remaining in the programmed pulldown period if the value is non-zero.

PROGRAMMABLE

Local Motor Current Limit

Access Level Required: OPERATOR

Allows the user to specify the maximum allowed motor current (as a percentage of FLA). When the motor current reaches this value, the pre-rotation vanes will not be permitted to open further. If the motor current rises above this value, the pre-rotation vanes will close to reduce the current to this value.

Pulldown Demand Limit

Access Level Required: OPERATOR

Allows the user to specify the current limit value (as a percentage of FLA) to which the chiller will be limited during the specified pulldown limit time. This value will override the Motor Current Limit value during this time period. This function is used to provide energy savings following chiller start-up.

Pulldown Demand Time

Access Level Required: OPERATOR

Allows the user to set a period of time for which the pulldown demand limit will be in effect after the chiller starts.

NAVIGATION

Home

Access Level Required: VIEW

Causes an instant return to the Home Screen.

MOD "A" SOLID STATE STARTER SCREEN

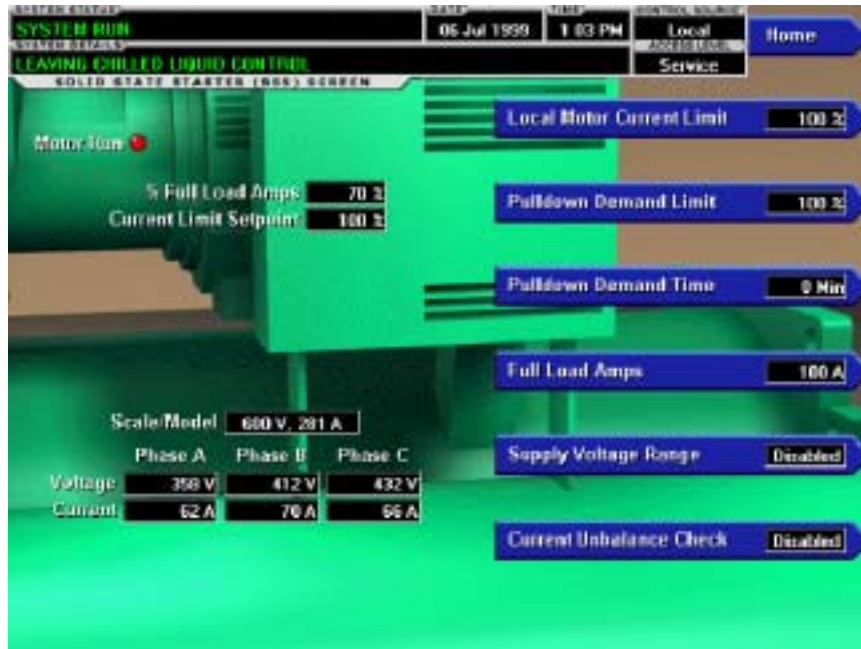

FIG. 17

0058VIP

OVERVIEW

This screen displays all information pertaining to the Mod "A" Solid State Starter.

DISPLAY ONLY

Motor Run (LED)

Indicates whether the digital output from the controls is commanding the motor to RUN.

Motor Current % Full Load Amps

Displays the motor current as a percentage of the Full Load Amps (FLA) value. For the Solid State Starter this is the data returned by the Starter Logic board.

Current Limit Setpoint

Displays the current limit value in use. This value could come from a 0-20mA, 4-20mA, 0-10VDC or 2-10VDC input in Analog Remote mode, PWM signal in Digital Remote mode, MicroGateway interface in ISN mode or a locally programmed value in local mode.

Pulldown Demand Time Left

Displays the time remaining in the programmed pull-down period.

Scale/Model

Display information about the Liquid Cooled-Solid State Starter Rating and the maximum allowed Full Load Amps.

Voltage - Phase A, B, C

Display the 3-phase input line voltage values being read from the Solid State Starter.

Current - Phase A, B, C

Display the 3-phase motor current values being read from the Solid State Starter.

PROGRAMMABLE

Local Motor Current Limit

Access Level Required: OPERATOR

Allows the user to specify the maximum allowed motor current (as a percentage of FLA). When the motor current reaches this value, the pre-rotation vanes will not be permitted to open further. If the motor current rises above this value, the pre-rotation vanes will close to reduce the current to this value.

Pulldown Demand Limit

Access Level Required: OPERATOR

Allows the user to specify the current limit value (as a percentage of FLA) to which the chiller will be limited during the specified pulldown limit time. This value will override the Motor Current Limit value during this time period. This function is used to provide energy savings following chiller start-up.

Pulldown Demand Time

Access Level Required: OPERATOR

Allows the user to set a period of time for which the pulldown demand limit will be in effect after the chiller starts.

Full Load Amps

Access Level Required: SERVICE

Define the maximum amps at which the motor can operate. This value is viewable when logged in under the Operator or View access level. Service Technicians refer to YORK Service Manual 160.55-M1.

Supply Voltage Range

Access Level Required: SERVICE

Allows the user to select a specific voltage range for voltage checking. When not disabled, this line voltage range is used to determine a low line and high line voltage

threshold for initiating a shutdown. Service Technicians refer to YORK Service Manual 160.55-M1.

Current Unbalance Check (Enabled / Disabled)

Access Level Required: SERVICE

Allows the user to control whether the logic checks for current unbalance and initiates a shutdown as a result. Service Technicians refer to YORK Service Manual 160.55-M1.

NAVIGATION

Home

Access Level Required: VIEW

Causes an instant return to the Home Screen.

MOD "B" SOLID STATE STARTER SCREEN

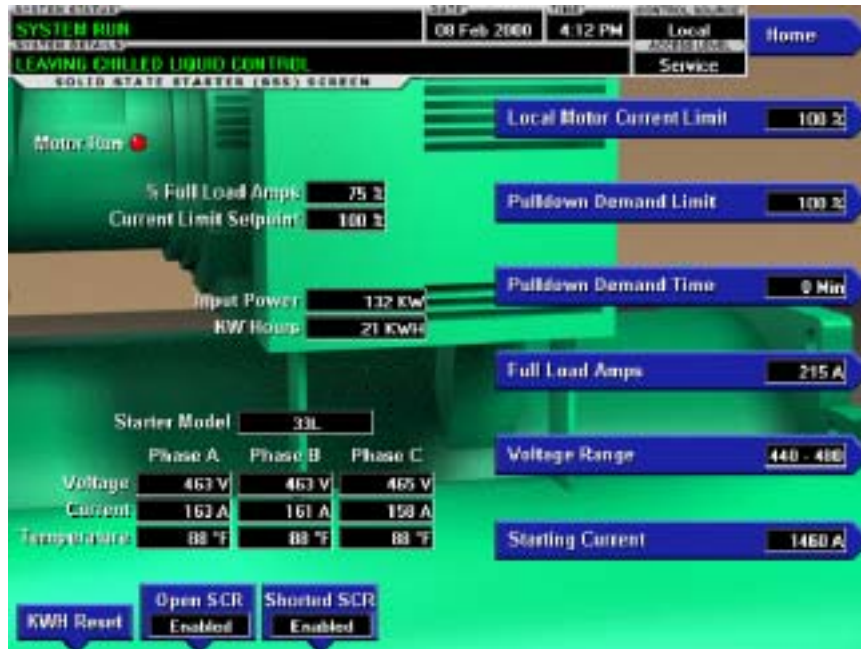

FIG. 18

00359VIP

OVERVIEW

This screen displays all information pertaining to the Mod "B" Solid State Starter.

DISPLAY ONLY

Motor Run (LED)

Indicates whether the digital output from the controls is commanding the motor to RUN.

Motor Current % Full Load Amps

Displays the motor current as a percentage of the Full Load Amps (FLA) value.

Current Limit Setpoint

Displays the current limit in use. This value could come from a 0-20mA, 4-20mA, 0-10VDC or 2-10VDC input in Analog Remote Mode, PWM signal in Digital Remote Mode, MicroGateway interface in ISN remote Mode or a locally programmed value in Local Mode.

Pulldown Demand Time Left

Displays the time remaining in the programmed pull-down period.

Input Power

Displays the Kilowatts measured by the Solid State Starter.

kW Hours

Displays the cumulative amount of kilowatts used over time.

Starter Model

Displays the Solid State Starter model that is applied to the chiller. Starter Models are 7L, 14L, 26L or 33L.

Voltage – Phase A, B, C

Displays the 3-phase input line voltage measured by the Solid State Starter.

Current – Phase A, B, C

Displays the 3-phase motor current values measured by the Solid State Starter.

Temperature – Phase A, B, C

Displays the temperatures of the Silicon Controlled Rectifier assemblies.

PROGRAMMABLE

Local Motor Current Limit

Access Level Required: OPERATOR

Allows the user to specify the maximum allowed motor current (as percentage of FLA). When the motor current reaches this value, the Pre-rotation Vanes will not be permitted to open further. If the motor rises above this value, the Pre-rotation Vanes will close to reduce the current to this value.

Pulldown Demand Limit

Access Level Required: OPERATOR

Allows the user to specify the current limit value (as a percentage of FLA) to which the chiller will be limited during the specified pulldown time. This value will override the Motor Current Limit value during this time period. This function is used to provide energy savings following chiller start.

Pulldown Demand Time

Access Level Required: OPERATOR

Allows the user to set a period of time for which the pulldown demand limit will be in effect after the chiller starts.

Full Load Amps

Access Level Required: SERVICE

Defines the maximum amps at which the motor can operate. This value is viewable when logged in at Operator or View access level. Service technicians refer to YORK Service Manual 160.55-M1.

Voltage Range

Access Level Required: SERVICE

Allows the user to select specific line voltage range for voltage checking. When not disabled, this line voltage range is used to determine a low line and high line voltage threshold for initiating a shutdown. Service Technicians refer to YORK Service Manual 160.55-M1.

Starting Current

Access Level Required: SERVICE

Defines the maximum allowed motor starting amps. The Solid State Starter will limit the motor starting current

to this value. Service technicians refer to YORK Service manual 160.55-M1.

Open SCR (Enabled/Disabled)

Access Level Required: SERVICE

Allows the user to enable or disable the Solid State Starter Open SCR safety detection. This must never be disabled unless under advisement of the YORK Factory. Service Technicians refer to YORK Service Manual 160.55-M1.

**Shorted SCR (Enabled/Disabled)
(Flash Memory Card version C.MLM.02.01 or later)**

Access Level required: SERVICE

Allows the user to enable or disable the Solid State Starter Shorted SCR safety detection. This must never be disabled unless under advisement of the York Factory. Service Technicians refer to YORK Service Manual 160.55-M1.

kWH Reset

Access Level Required: SERVICE

Allows the user to reset the cumulative Kilowatt Hours. Service technicians refer to YORK Service Manual 160.55-M1.

NAVIGATION**HOME**

Access Level Required: VIEW

Causes an instant return to the HOME Screen.

VARIABLE SPEED DRIVE SCREEN



FIG. 19

00360VIP

OVERVIEW

This screen displays information pertaining to a Variable Speed Drive (VSD).

DISPLAY ONLY

Motor Run (LED)

Indicates whether the digital output from the controls is commanding the motor to RUN.

Motor Current % Full Load Amps

Displays the motor current as a percentage of the Full Load Amps (FLA) value.

Current Limit Setpoint

Displays the current limit value in use. This value could come from a 0-20mA, 4-20mA, 0-10VDC or 2-10VDC input in Analog Remote mode, PWM signal in Digital Remote mode, MicroGateway interface in ISN mode or a locally programmed value.

Pulldown Demand Time Left

Displays the time remaining in the programmed pull-down period if the value is non-zero.

Output Voltage

Displays the output voltage measured to the motor.

Output Frequency

Displays the present output frequency to the motor.

Output Current - Phase A, B, C

Displays the phase current measured to the motor.

Input Power

Displays the total Kilowatts measured by the VSD or Harmonic Filter, if installed.

kW Hours

Displays the cumulative amount of kilowatts used over time as the VSD motor controller operates.

Pre-Rotation Vane Position

Displays the pre-rotation vane position as a value between 0 and 100%.

Harmonic Filter Data (Harmonic Filter installed only)

Supply kVA

Displays the supply kva measured by the filter.

Total Power Factor

Displays the relationship between the Input Power and the Supply kVA.

Voltage Total Harmonic Distortion - L1, L2, L3

Displays the Total Harmonic Distortion (THD) for each of the voltage lines as calculated by the filter.

Supply Current Total Demand Distortion - L1, L2, L3

Displays the Total Dynamic Distortion (TDD) for each of the supply current lines as calculated by the filter.

PROGRAMMABLE

Local Motor Current Limit

Access Level Required: OPERATOR

Allows the user to specify the maximum allowed motor current (as a percentage of FLA). When the motor current reaches this value, the pre-rotation vanes will not be permitted to open further. If the motor current rises above this value, the pre-rotation vanes will close to reduce the current to this value.

Pulldown Demand Limit

Access Level Required: OPERATOR

Allows the user to specify the current limit value (as a percentage of FLA) to which the chiller will be limited during the specified pulldown limit time. This value will override the Motor Current Limit value during this time period. This function is used to provide energy savings following chiller start-up.

Pulldown Demand Time

Access Level Required: OPERATOR

Allows the user to set a period of time for which the pulldown demand limit will be in effect after the chiller starts.

kWH Reset

Access Level Required: SERVICE

Allows the user to reset the cumulative Kilowatt Hours. Service Technicians refer to YORK Service Manual 160.55-M1.

Filter Inhibit (Harmonic Filter installed only)

Access Level Required: SERVICE

Disable the filter logic from activating, although the system will still communicate with the device. Only available when chiller is stopped.

2

NAVIGATION

Home

Access Level Required: VIEW

Causes an instant return to the Home Screen.

VSD Details

Access Level Required: VIEW

Moves to the subscreen which provides more information about the Variable Speed Drive.

ACC Details

Access Level Required: SERVICE

Moves to the subscreen which provides more information about the Adaptive Capacity Control.

Filter Details (Harmonic Filter installed only)

Access Level Required: VIEW

Moves to the subscreen which provides more information about the Harmonic Filter.

VARIABLE SPEED DRIVE DETAILS SCREEN (STYLE D VSD AND VSD WITH PART NUMBER 371-03789-XXX (503 HP 60 HZ; 410 HP 50 HZ))



FIG. 20

LD09096

OVERVIEW

This screen displays more detailed information pertaining to a Variable Speed Drive (VSD). Flash Memory Card version C.MLM.02.04.xxx (and later) is required for VSD part number 371-03789-xxx (503HP 60Hz; 419 HP 50Hz). Service Technicians refer to YORK Service Manual 160.55-M1 for operation instructions and explanation of all programmable setpoints and displayed values.

DISPLAY ONLY

Motor Run (LED)

Indicates whether the digital output from the controls is commanding the motor to RUN.

Motor Current % Full Load Amps

Displays the motor current as a percentage of the Full Load Amps (FLA) value. For the Variable Speed Drive this is the data returned by the VSD Logic board.

Current Limit Setpoint

Displays the current limit value in use. This value could come from a 0-20mA, 4-20mA, 0-10VDC or 2-10VDC input in Analog Remote mode, PWM signal in Digital

Remote mode, MicroGateway interface in ISN mode or a locally programmed value.

Pulldown Demand Time Left

Displays the time remaining in the programmed pull-down period if the value is non-zero.

Water Pump Output (LED)

Indicates whether the relay controlling the water pump output is energized.

Precharge Relay Output (LED)

Indicates whether the relay controlling the precharge output is energized.

Trigger SCR Output (LED)

Indicates whether the relay controlling the trigger SCR output is energized.

DC Bus Voltage

Displays the DC Bus voltage as reported by the VSD.

DC Inverter Link Current

Displays the DC Inverter link current as reported by the VSD.

Internal Ambient Temperature

Displays the ambient temperature inside the VSD cabinet as reported by the VSD.

Converter Heatsink Temperature

Displays the heatsink temperature of the converter as reported by the VSD.

Baseplate Temperature - Phase A, B, C

(“Labeled “Heatsink Temperatures on VSD Style D)
Displays the baseplate temperature of each of the 3-phase voltage regulators as reported by the VSD

VSD Model

Access Level Required: SERVICE

Displays the Horsepower configuration of the Variable Speed Drive control.

100% Full Load Amps

Displays the full load amps value as reported by the VSD.

PROGRAMMABLE**Local Motor Current Limit**

Access Level Required: OPERATOR

Allows the user to specify the maximum allowed motor current (as a percentage of FLA). When the motor current reaches this value, the pre-rotation vanes will not be permitted to open further. If the motor current rises above this value, the pre-rotation vanes will close to reduce the current to this value.

Pulldown Demand Limit

Access Level Required: OPERATOR

Allows the user to specify the current limit value (as a percentage of FLA) to which the chiller will be limited during the specified pulldown limit time. This value will override the Motor Current Limit value during this time period. This function is used to provide energy savings following chiller start-up.

Pulldown Demand Time

Access Level Required: OPERATOR

Allows the user to set a period of time for which the pulldown demand limit will be in effect after the chiller starts.

NAVIGATION**Home**

Access Level Required: VIEW

Causes an instant return to the Home Screen.

VSD

Access Level Required: VIEW

Returns to the VSD Screen.

VARIABLE SPEED DRIVE DETAILS SCREEN

(APPLICABLE TO VSD WITH PART NUMBER 371-02767-XXX (60 HZ) OR 371-03700-XXX (50 HZ))

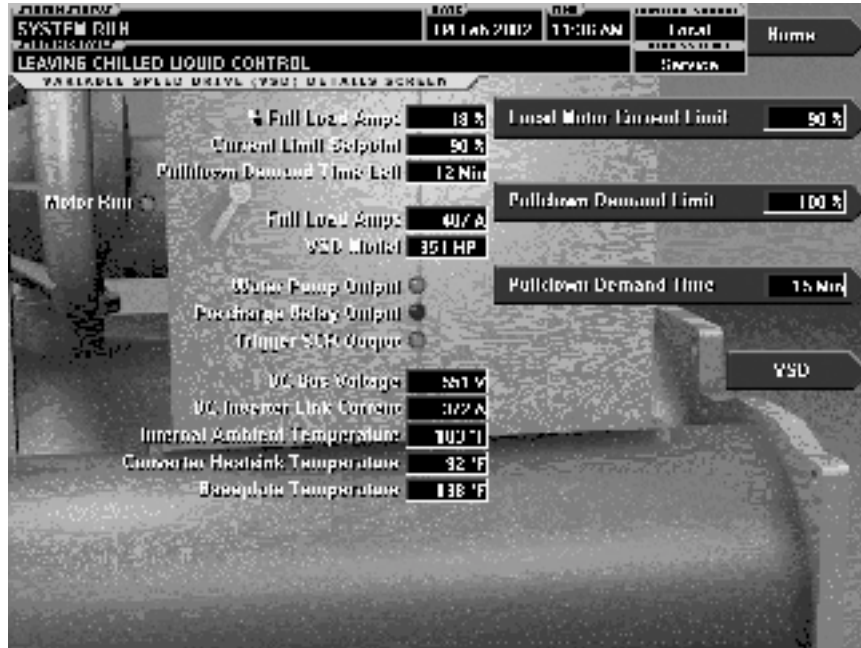

FIG. 21

00562VIP

OVERVIEW

This screen displays more detailed information pertaining to a Variable Speed Drive (VSD). Service Technicians refer to YORK Service Manual 160.55-M1 for operation instructions and explanation of all programmable setpoints and displayed values.

DISPLAY ONLY

Motor Run (LED)

Indicates whether the digital output from the controls is commanding the motor to RUN.

Motor Current % Full Load Amps

Displays the motor current as a percentage of the Full Load Amps (FLA) value. For the Variable Speed Drive this is the data returned by the VSD Logic board.

Current Limit Setpoint

Displays the current limit value in use. This value could come from a 0-20mA, 4-20mA, 0-10VDC or 2-10VDC input in Analog Remote mode, PWM signal in Digital Remote mode, MicroGateway interface in ISN mode or a locally programmed value.

Pulldown Demand Time Left

Displays the time remaining in the programmed pull-down period if the value is non-zero.

Water Pump Output (LED)

Indicates whether the relay controlling the water pump output is energized.

Precharge Relay Output (LED)

Indicates whether the relay controlling the precharge output is energized.

Trigger SCR Output (LED)

Indicates whether the relay controlling the trigger SCR output is energized.

DC Bus Voltage

Displays the DC Bus voltage as reported by the VSD.

DC Inverter Link Current

Displays the DC Inverter link current as reported by the VSD.

Internal Ambient Temperature

Displays the ambient temperature inside the VSD cabinet as reported by the VSD.

Converter Heatsink Temperature

Displays the heatsink temperature of the converter as reported by the VSD.

Baseplate Temperature

Displays the Baseplate temperature of the 3-phase voltage regulators as reported by the VSD.

VSD Model

Access Level Required: SERVICE

Displays the Horsepower configuration of the Variable Speed Drive control.

100% Full Load Amps

Displays the full load amps value as reported by the VSD.

PROGRAMMABLE**Local Motor Current Limit**

Access Level Required: OPERATOR

Allows the user to specify the maximum allowed motor current (as a percentage of FLA). When the motor current reaches this value, the pre-rotation vanes will not be permitted to open further. If the motor current

rises above this value, the pre-rotation vanes will close to reduce the current to this value.

Pulldown Demand Limit

Access Level Required: OPERATOR

Allows the user to specify the current limit value (as a percentage of FLA) to which the chiller will be limited during the specified pulldown limit time. This value will override the Motor Current Limit value during this time period. This function is used to provide energy savings following chiller start-up.

Pulldown Demand Time

Access Level Required: OPERATOR

Allows the user to set a period of time for which the pulldown demand limit will be in effect after the chiller starts.

NAVIGATION**Home**

Access Level Required: VIEW

Causes an instant return to the Home Screen.

VSD

Access Level Required: VIEW

Returns to the VSD Screen.

ADAPTIVE CAPACITY CONTROL DETAILS SCREEN

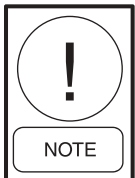

FIG. 22

00362VIP

OVERVIEW

This screen displays more detailed information pertaining to a Adaptive Capacity Control (ACC).



Requires a login access level of SERVICE. Service Technicians refer to YORK Service Manual 160.55-M1 for operation instructions and explanation of all programmable setpoints and displayed values.

DISPLAY ONLY

Motor Run (LED)

Indicates whether the digital output from the controls is commanding the motor to RUN.

Motor Current % Full Load Amps

Displays the motor current as a percentage of the Full Load Amps (FLA) value. For the Variable Speed Drive this is the data returned by the VSD Logic board.

Current Limit Setpoint

Displays the current limit value in use. This value could come from a 0-20mA, 4-20mA, 0-10VDC or 2-10VDC input in Analog Remote mode, PWM signal in Digital Remote mode, MicroGateway interface in ISN mode or a locally programmed value.

Pulldown Demand Time Left

Displays the time remaining in the programmed pull-down period if the value is non-zero.

VSD Output Frequency

Displays the frequency at which the VSD is operating the motor.

Pre-Rotation Vane Position

Displays the pre-rotation vane position as a value between 0 and 100%.

Surge Count

The total number of surge conditions detected by the Adaptive Capacity Control. The surge events detected by the Surge Protection feature are not included in this total.

Delta P/P

The value calculated by the Condenser and Evaporator pressures as reported by the Adaptive Capacity Control.

PROGRAMMABLE

Local Motor Current Limit

Allows the user to specify the maximum allowed motor current (as a percentage of FLA). When the motor current reaches this value, the pre-rotation vanes will not be permitted to open further. If the motor current rises above this value, the pre-rotation vanes will close to reduce the current to this value.

Pulldown Demand Limit

Allows the user to specify the current limit value (as a percentage of FLA) to which the chiller will be limited during the specified pulldown limit time. This value will override the Motor Current Limit value during this time period. This function is used to provide energy savings following chiller start-up.

Pulldown Demand Time

Allows the user to set a period of time for which the pulldown demand limit will be in effect after the chiller starts.

Stability Limit

Adjusting this value modifies the pre-rotation vane control algorithm when used in conjunction with an ACC.

Surge Margin Adjust

When the ACC maps a surge point, it will begin to adjust the chiller command frequency and vane controls at a certain “margin” from the mapped point. This programmable value allows the service technician to modify the “margin” at which these adjustments will begin to take place.

Manual Surge Point

This key will force the ACC to map a surge detection at the present operating conditions. Mapping a point at these conditions will cause the ACC to make adjustments to the command frequency in the future in order

to prevent the chiller from operating at the conditions mapped. ***USE WITH CAUTION.***

ACC Auto Map Print (Enabled / Disabled)

The chiller monitors the ACC communications and when a surge point is mapped, a short report of system parameters is printed. *When this function is active, all other printing capability is disabled.*

ACC Map Report

The chiller requests the entire surge map from the ACC. As the map is received, the parameters for each point are printed.

Surge Map Clear

This key instructs the ACC to clear all of the surge points presently mapped. This key will require confirmation of its selection by entry of a special password. ***USE WITH CAUTION.***

NAVIGATION**Home**

Access Level Required: VIEW

Causes an instant return to the Home Screen.

VSD

Access Level Required: VIEW

Returns to the VSD Screen.

HARMONIC FILTER DETAILS SCREEN

(STYLE D VSD AND VSD WITH PART NUMBER 371-03789-XXX
(503 HP 60 HZ; 410 HP 50 HZ)

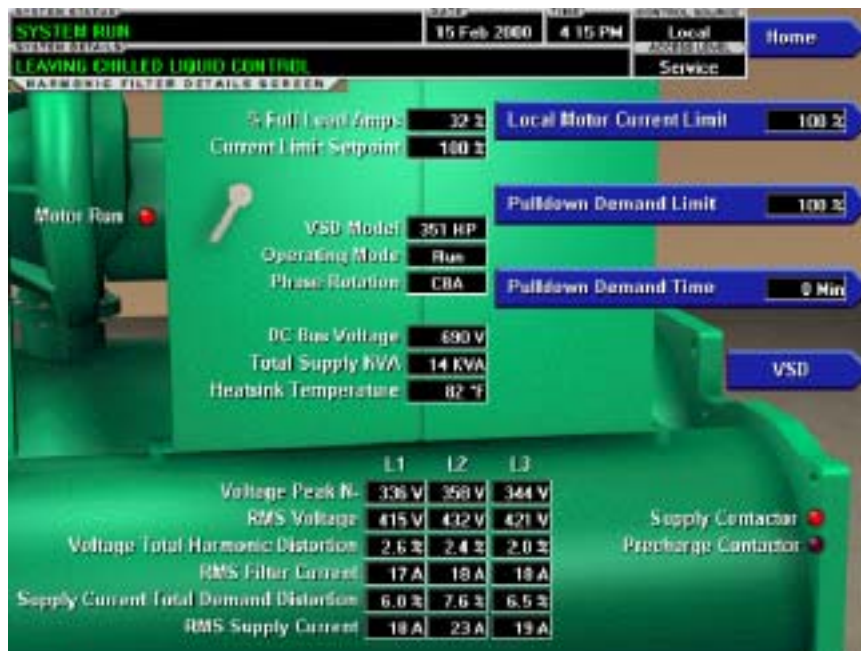

FIG. 23

00363VIP

OVERVIEW

This screen displays more detailed information pertaining to the IEEE-519 Harmonic Filter. Flash Memory Card version C.MLM.02.04.xxx (and later) is required for VSD part number 371-03789-xxx (503HP 60Hz; 419 HP 50Hz).

DISPLAY ONLY

Motor Run (LED)

Indicates whether the digital output from the controls is commanding the motor to RUN.

Motor Current % Full Load Amps

Displays the motor current as a percentage of the Full Load Amps (FLA) value. For the Variable Speed Drive this is the data returned by the VSD Logic board.

Current Limit Setpoint

Displays the current limit value in use. This value could come from a 0-20mA, 4-20mA, 0-10VDC or 2-10VDC input in Analog Remote mode, PWM signal in Digital Remote mode, MicroGateway interface in ISN mode or a locally programmed value.

Pulldown Demand Time Left

Displays the time remaining in the programmed pulldown period if the value is non-zero.

Operating Mode (Run / Stop)

Indicates whether the Harmonic Filter is operating.

VSD Model

Access Level Required: SERVICE

Displays the horsepower for which the attached Harmonic Filter is configured.

DC Bus Voltage

Displays the DC Bus voltage as measured by the Harmonic Filter.

Supply Contactor (LED)

Indicates whether the output to the Supply Contactor is energized.

Precharge Contactor (LED)

Indicates whether the output to the Precharge Contactor is energized.

Phase Rotation

Displays the phase rotation detected by the Harmonic Filter (A, B, C or C, B, A)

Total Supply kVA

Displays the total supply KiloVolt-Amps measured by the Harmonic Filter.

Heatsink Temperature

(Labeled “Baseplate Temperatures” on VSD with part number 371-03789-xxx {503HP 60Hz; 419HP 50Hz}).

Displays the temperature of the Harmonic Filter Heat-sink.

Voltage Peak (N-L1, N-L2, N-L3)

Displays the 3-phase peak voltages as measured by the Harmonic Filter (Neutral to Line).

RMS Voltage (L1-L2, L2-L3, L3-L1)

Displays the 3-phase RMS Voltages across each line.

Voltage Total Harmonic Distortion (L1, L2, L3)

Displays the 3-phase voltage Total Harmonic Distortion (THD) measurements.

RMS Filter Current (L1, L2, L3)

Displays the 3-phase Filter current values as measured by the Harmonic Filter.

Supply Current Total Demand Distortion (L1, L2, L3)

Displays the 3-phase Current Total Demand Distortion (TDD) measurements.

RMS Supply Current (L1, L2, L3)

Displays the 3-phase RMS Voltages across each line.

PROGRAMMABLE**Local Motor Current Limit**

Access Level Required: OPERATOR

Allows the user to specify the maximum allowed mo-

tor current (as a percentage of FLA). When the motor current reaches this value, the pre-rotation vanes will not be permitted to open further. If the motor current rises above this value, the pre-rotation vanes will close to reduce the current to this value.

Pulldown Demand Limit

Access Level Required: OPERATOR

Allows the user to specify the current limit value (as a percentage of FLA) to which the chiller will be limited during the specified pulldown limit time. This value will override the Motor Current Limit value during this time period. This function is used to provide energy savings following chiller start-up.

Pulldown Demand Time

Access Level Required: OPERATOR

Allows the user to set a period of time for which the pulldown demand limit will be in effect after the chiller starts.

NAVIGATION**Home**

Access Level Required: VIEW

Causes an instant return to the Home Screen.

VSD

Access Level Required: VIEW

Returns to the VSD Screen.

HARMONIC FILTER DETAILS SCREEN

(VSD WITH PART NUMBER 371-02767-XXX (60 HZ) OR 371-03700-XXX (50 HZ))

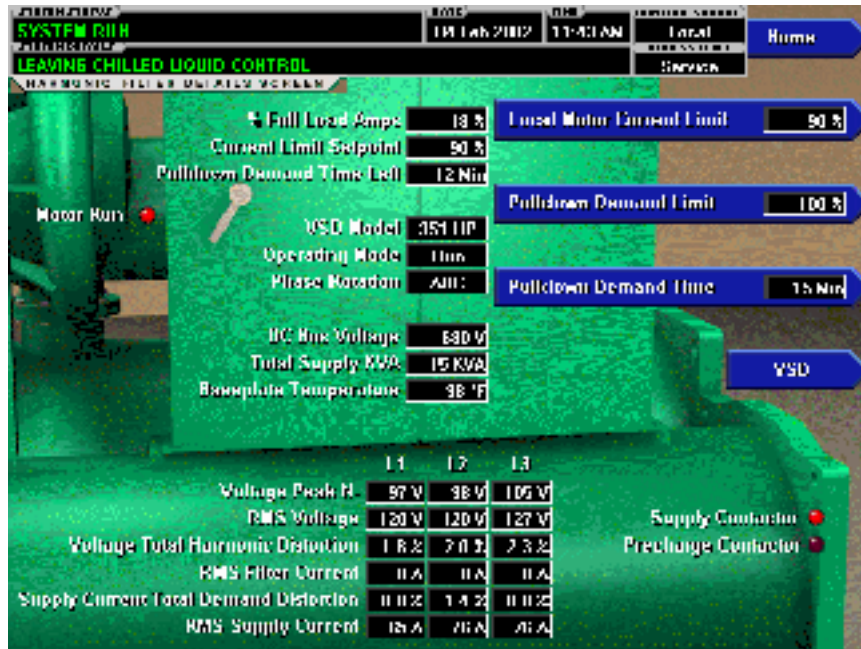

FIG. 24

00567VIP

OVERVIEW

This screen displays more detailed information pertaining to the IEEE-519 Harmonic Filter.

DISPLAY ONLY

Motor Run (LED)

Indicates whether the digital output from the controls is commanding the motor to RUN.

Motor Current % Full Load Amps

Displays the motor current as a percentage of the Full Load Amps (FLA) value. For the Variable Speed Drive this is the data returned by the VSD Logic board.

Current Limit Setpoint

Displays the current limit value in use. This value could come from a 0-20mA, 4-20mA, 0-10VDC or 2-10VDC input in Analog Remote mode, PWM signal in Digital Remote mode, MicroGateway interface in ISN mode or a locally programmed value.

Pulldown Demand Time Left

Displays the time remaining in the programmed pull-down period if the value is non-zero.

Operating Mode (Run / Stop)

Indicates whether the Harmonic Filter is operating.

VSD Model

Access Level Required: SERVICE

Displays the horsepower for which the attached Harmonic Filter is configured.

DC Bus Voltage

Displays the DC Bus voltage as measured by the Harmonic Filter.

Supply Contactor (LED)

Indicates whether the output to the Supply Contactor is energized.

Precharge Contactor (LED)

Indicates whether the output to the Precharge Contactor is energized.

Phase Rotation

Displays the phase rotation detected by the Harmonic Filter (A, B, C or C, B, A)

Total Supply KVA

Displays the total supply KiloVolt-Amps measured by the Harmonic Filter.

Baseplate Temperature

Displays the temperature of the Harmonic Filter Baseplate.

Voltage Peak (N-L1, N-L2, N-L3)

Displays the 3-phase peak voltages as measured by the Harmonic Filter (Neutral to Line).

RMS Voltage (L1-L2, L2-L3, L3-L1)

Displays the 3-phase RMS Voltages across each line.

Voltage Total Harmonic Distortion (L1, L2, L3)

Displays the 3-phase voltage Total Harmonic Distortion (THD) measurements.

RMS Filter Current (L1, L2, L3)

Displays the 3-phase Filter current values as measured by the Harmonic Filter.

Supply Current Total Demand Distortion (L1, L2, L3)

Displays the 3-phase Current Total Demand Distortion (TDD) measurements.

RMS Supply Current L1, L2, L3

Displays the 3-phase RMS Voltages across each line.

PROGRAMMABLE**Local Motor Current Limit**

Access Level Required: OPERATOR

Allows the user to specify the maximum allowed motor current (as a percentage of FLA). When the motor

current reaches this value, the pre-rotation vanes will not be permitted to open further. If the motor current rises above this value, the pre-rotation vanes will close to reduce the current to this value.

Pulldown Demand Limit

Access Level Required: OPERATOR

Allows the user to specify the current limit value (as a percentage of FLA) to which the chiller will be limited during the specified pulldown limit time. This value will override the Motor Current Limit value during this time period. This function is used to provide energy savings following chiller start-up.

Pulldown Demand Time

Access Level Required: OPERATOR

Allows the user to set a period of time for which the pulldown demand limit will be in effect after the chiller starts.

NAVIGATION**Home**

Access Level Required: VIEW

Causes an instant return to the Home Screen.

VSD

Access Level Required: VIEW

Returns to the VSD Screen.

SETPOINTS SCREEN



FIG. 25

00364VIP

OVERVIEW

This screen provides a convenient location for programming the most common setpoints involved in the chiller control. This screen also serves as a gateway to a subscreen for defining the setup of general system parameters.

DISPLAY ONLY

Leaving Chilled Liquid Temperature - Setpoint

Displays the present setpoint to which the chiller is operating whether controlled remotely or locally. This value could come from a 0-20mA, 4-20mA, 0-10VDC or 2-10VDC input in Analog Remote mode, PWM signal in Digital Remote mode, MicroGateway interface in ISN mode or a locally programmed value.

Leaving Chilled Liquid Temperature Cycling - Shutdown

Displays the Leaving Chilled Liquid Temperature at which the chiller will shut down to avoid over-cooling the building. This value is calculated by subtracting the Leaving Chilled Liquid Temperature Cycling Offset – Shutdown from the Leaving Chilled Liquid Temperature Setpoint. If this value is below the absolute minimum allowed shutdown temperature the minimum value is displayed.

Leaving Chilled Liquid Temperature Cycling – Restart

Displays the Leaving Chilled Liquid Temperature at which

the chiller will restart after it has shut down due to over-cooling temperature. This value is calculated by adding the Leaving Chilled Liquid Temperature Cycling Offset – Restart to the Leaving Chilled Liquid Temperature Setpoint.

Current limit Setpoint

Displays the active Current Limit setpoint. In Local mode, this is the locally programmed Current Limit setpoint. In ISN remote mode, this is the setpoint received from the MicroGateway interface. In Analog remote mode, this is the setpoint received via 0-10VDC, 2-10VDC, 0-20mA or 4-20mA input. In Digital remote mode, this is the Pulse Width Modulation input.

PROGRAMMABLE

Local Leaving Chilled Liquid Temperature - Range *Access Level Required: OPERATOR*

This is the range over which an analog signal (0-20mA, 4-20mA, 0-10VDC or 2-10VDC) in Analog Remote Mode or a digital signal (PWM) in Digital remote mode can reset the Leaving Chilled Liquid Temperature setpoint above the operator programmed **Base** Setpoint (see below). Programmable as either 10°F or 20°F, with a default of 20°F, it is added to the *BASE* value to create a range over which the remote device can reset the setpoint. For example, if this setpoint is programmed for 10°F and the operator programmed value is 45°F, then the remote device can set the Leaving Chilled Liquid Temperature setpoint over the range 45.0° - 55.0°F.

Local Leaving Chilled Liquid Temperature - Setpoint

Access Level Required: OPERATOR

This value allows the user to define the Leaving Chilled Liquid Temperature that is to be maintained by the chiller. It is programmable over the range of 38.0°F to 70.0°F (water) or 10.0°F to 70.0°F (brine). If Smart Freeze is enabled, the range is 36.0°F to 70.0°F (water). A remote device can provide an analog signal (0-20mA, 4-20mA, 0-10VDC or 2-10VDC) in Analog Remote mode or PWM signal in Digital Remote mode that changes the setpoint by creating an offset above the operator programmed *BASE* Leaving Chilled Liquid Temperature setpoint. This offset may be defined up to 10.0°F or 20.0°F above the *BASE* setpoint (see the Remote Leaving Chilled Liquid Temperature Setpoint Range description above). Additionally, a MicroGateway (in ISN Remote mode) can define the setpoint through a serial data stream. In this case, the incoming setpoint is not an offset that is applied to the locally programmed *BASE* setpoint value, but rather is the setpoint value itself.

Leaving Chilled Liquid Temperature Cycling Offset - Shutdown

Access Level Required: OPERATOR

This value allows the user to specify the Leaving Chilled Liquid Temperature at which the chiller will shut down on a **LEAVING CHILLED LIQUID – LOW TEMPERATURE** cycling shutdown. This is done by defining an offset below the Leaving Chilled Liquid Temperature setpoint. It is programmable over a range of 1°F to 64°F below the setpoint, to a minimum cutout of 36°F (water), 34°F (water with Smart Freeze enabled) or 6°F (brine). It establishes the minimum allowed temperature for the Leaving Chilled Liquid Temperature and prevents overcooling of the building. Anytime the Leaving Chilled Liquid Temperature setpoint is increased, the shutdown threshold is 36.0°F (water) or 6.0°F (brine) for the next ten (10) minutes. If Smart Freeze is enabled, the threshold is 34.0°F for the next 10 minutes. After ten (10) minutes have elapsed, the shutdown threshold becomes the programmed setpoint value.

Leaving Chilled Liquid Temperature Cycling Offset - Restart

Access Level Required: OPERATOR

This value allows the user to specify the Leaving Chilled Liquid Temperature at which the chiller will restart after a shutdown on a **LEAVING CHILLED LIQUID – LOW TEMPERATURE** cycling shutdown. This is done by defining an offset above the Leaving Chilled Liquid Temperature setpoint. It is programmable over a range of 0°F to 70°F above the setpoint, to a maximum restart

value of 80°F. The chiller will automatically restart when this temperature is reached. This setpoint can be used to reduce chiller cycling by delaying the chiller restart until the cooling load has increased.

Remote Analog Input Range

Access Level Required: OPERATOR

This setpoint defines, for the Control Center, the remote signal range applied for remote reset of the Leaving Chilled Liquid Temperature Setpoint and Current Limit Setpoint in ANALOG remote mode. If the remote signal is 0-10VDC or 0-20mA, this setpoint must be programmed for 0-10VDC. If the remote signal is 2-10VDC or 4-20mA, this setpoint must be programmed for 2-10VDC.

Local Motor Current Limit

Access Level Required: OPERATOR

Allows the user to specify the maximum allowed motor current (as a percentage of FLA). When the motor current reaches this value, the pre-rotation vanes will not be permitted to open further. If the motor current rises above this value, the pre-rotation vanes will close to reduce the current to this value.

Pulldown Demand Limit

Access Level Required: OPERATOR

Allows the user to specify the current limit value (as a percentage of Full Load Amps) to which the chiller will be limited during the specified pulldown limit time. This value will override the Motor Current Limit value during this time period. This function is used to provide energy savings following chiller start-up.

Pulldown Demand Time

Access Level Required: OPERATOR

Allows the user to set a period of time for which the pulldown demand limit will be in effect after the chiller starts.

Print

Access Level Required: VIEW

Generates **Setpoints** print report.

NAVIGATION

Home

Access Level Required: VIEW

Causes an instant return to the Home Screen.

Setup

Access Level Required: VIEW

Moves to the subscreen allowing setup of general system parameters.

SETUP SCREEN



FIG. 26

LD09562

OVERVIEW

This screen is the top level of the general configuration parameters. It allows programming of the time and date, along with specifications as to how the time will be displayed (12 or 24 hour format). In addition, the chiller configuration, as determined by the state of the Microboard Program Jumpers and Program Switches is displayed. A qualified Service Technician, following instructions in YORK Service Manual 160.55-M1, establishes this configuration per the desired operation. This screen also serves as a gateway to more subscreens for defining general system parameters

DISPLAY ONLY

031-01730-000 Microboard

Chilled Liquid Pump Operation:

Displays **Standard** or **Enhanced**

Motor Type:

Displays **Fixed Speed** or **Variable Speed**

Refrigerant Selection:

Displays **R-11** or **R123**

Anti-Recycle:

Displays **Disabled** or **Enabled**

Power Failure Restart:

Displays **Manual** or **Automatic**

Liquid Type:

Displays **Water** or **Brine**

Cooldown:

Displays **Standard** (150 seconds) or **Enhanced** (15 minutes – Steam Turbine applications)

Pre-Run:

Displays **Standard** (30 seconds) or **Extended** (180 seconds)

Power Line Frequency (VSD only):

Displays **60 Hz** or **50 Hz**

031-02430-000 Microboard

Refrigerant Selection

Displays R11 or R123

Liquid Type

Displays Water or Brine

PROGRAMMABLE

Set Date

Access Level Required: OPERATOR

Allows the user to specify the present date. This value is critical to logging system shutdowns accurately and for utilizing the scheduling capabilities. When prompted to enter a date value, the user must enter the day, month and four-digit year (using leading zeroes as necessary). If within range, the value will be accepted. If out of range, the user is prompted for the information again. At this point the user may retry the date entry or cancel the programming attempt.

Set Time

Access Level Required: OPERATOR

Allows the user to specify the present time. This value is critical to logging system shutdowns accurately and for utilizing the scheduling capabilities. When prompted to enter a time value, the user must enter the hour and minute desired (using leading zeroes as necessary). If the chiller is presently set to 24-hour mode, the time must be entered in the 24-hour format. Otherwise, the user must also select AM or PM for the entered time. If out of range, the user is prompted for the information again. At this point the user may retry the time entry or cancel the programming attempt.

Clock (Enabled / Disabled)

Access Level Required: OPERATOR

Allows the user to enable or disable the real-time clock in order to conserve battery life. The clock will be disabled during manufacturing and must be enabled at system commissioning. In addition, when preparing for prolonged shutdown the clock should once again be disabled.

12/24 Hr

Access Level Required: OPERATOR

Allows the user to specify the format in which the time will be presented to the user. This setpoint will affect the display of the time on the chiller panel and on all reports generated. 12-Hour time format will include the **AM** and **PM** modifiers and show the range of time between 1:00 and 12:59, while the 24-Hour time format will show the range of time between 0:00 and 23:59.

. 031-02430-000 Microboard only

Change Settings

Access Level Required: OPERATOR

Used to enter the following setpoints. Pressing this key places a green selection box around the first changeable setpoint. The access level determines which setpoints

can be changed. Use the ▲ and ▼ keys to place the selection box around the desired setpoint. With the setpoint selected, press the ENTER (√) key. A dialog box appears with the range of settings.

Chilled Liquid Pump Operation

Access Level Required: SERVICE

Allows a Service Technician to select chilled liquid pump control contacts (I/O Board TB2-44/45) operation as either Standard or Enhanced. Service Technicians refer to YORK Service Manual 160.55-M1.

Motor Drive Type

Access Level Required: SERVICE

Allows a Service Technician to enter the applied compressor motor type as either electro-mechanical (EM), Solid State Starter (SSS-Mod A), Solid State starter (SSS – Mod B), Variable Speed Drive-60Hz or Variable Speed Drive-50Hz. Service Technicians refer to YORK Service manual 160.55-M1.

Anti-Recycle

Access level Required: SERVICE

Allows a Service Technician to Enable or Disable the anti-recycle timer. Service Technicians refer to YORK Service manual 160.55-M1.

Power Failure Restart

Access Level Required: OPERATOR

Allows the user to select Manual or Automatic restart after power failure.

Coastdown

Access Level Required: SERVICE

Allows a Service Technician to select either Standard (150 seconds) or Enhanced 15 minutes –Steam Turbine applications). Service Technicians refer to YORK Service manual 160.55-M1.

Pre-Run

Access Level Required: SERVICE

Allows Service Technician to select either Standard (30 seconds) or Extended (180 seconds)

NAVIGATION

Home

Access Level Required: VIEW

Causes an instant return to the Home Screen.

Schedule

Access Level Required: VIEW

Moves to the subscreen allowing definition of the chiller operation schedule.

Diagnostics

Access Level Required: SERVICE

Moves to the subscreen allowing limited diagnostic capability while operating. Refer to YORK Service Manual 160.55-M1

Comms

Access Level Required: VIEW

Moves to the subscreen allowing configuration of system communications.

Printer

Access Level Required: VIEW

Moves to the subscreen allowing configuration and control of printer functions.

Sales Order

Access Level Required: VIEW

Moves to the subscreen displaying the Sales Order information for the chiller system.

Operations

Access Level Required: VIEW

Moves to the subscreen displaying operating parameters of the chiller system.

User

Access Level Required: VIEW

Moves to the subscreen allowing configuration of user preferences.

**THIS PAGE INTENTIONALLY LEFT BLANK
TO MAINTAIN FORMAT**

SCHEDULE SCREEN



FIG. 27

00365VIP

OVERVIEW

The schedule screen contains more programmable values than a normal display screen. As such, each programmable value is not linked to a specific button. Instead the **Select** key is used to enable the cursor arrows which are used to highlight the day and the start or stop time the user wishes to modify. At this point the user may press the '✓' (**ENTER**) key to program the Start / Stop times for that day.

In order for the Start / Stop combination to be utilized, each Start time must have a corresponding Stop time which occurs later in the day. The presently programmed schedule for a given day can be cancelled by setting both the Start time and Stop time to 12:00AM. If the Start time equals the Stop time (with any time other than 12:00AM), the chiller is OFF for that day. If the user desires the chiller to operate continuously through several days, the Stop time of Day 1 can be set to 11:59 PM and the Start time of Day 2 can be set to 12:00 AM. The chiller will not stop but continue to operate until the stop of Day 2.

The user has the ability to define a standard set of Start / Stop times which are utilized every week. The user may then specify *exception* Start / Stop combinations for any day of the week up to 6 weeks in advance. At the end of each week the schedule for the next week is created by combining the standard week definition and the next

defined exception week. The schedule is then updated as each of the exception weeks “shifts down”, leaving a new, blank exception week in the 6th week slot.

DISPLAY ONLY

None

PROGRAMMABLE

Standard Week Start/Stop Times

Access Level Required: OPERATOR

For each day of the week, the user may specify a time for the chiller to start and a time for the chiller to stop. The times specified in this entry week will be used as the default for every week of chiller operation.

Exception Start/Stop Times

Access Level Required: OPERATOR

For each day of the week, the user may specify a time for the chiller to start and a time for the chiller to stop. These Start / Stop combinations may be scheduled up to five (5) weeks in advance and also for the present week. As each week goes by, the new schedule will be created for the present week using the Exception specification in combination with the Standard week definition, as described above.

Schedule (Enabled / Disabled)

Access Level Required: OPERATOR

Allows the user to enable or disable the monitoring func-

tion which enforces the scheduled starting and stopping of the chiller.

Repeat Sunday Schedule

Access Level Required: OPERATOR

Duplicates the schedule defined for Sunday for the remainder of the standard weekdays.

Reset All Exception Days

Access Level Required: OPERATOR

Deletes all programming for exception days within the next 6 weeks.

Select

Access Level Required: OPERATOR

Places a selection box around a start time for a given day.

Use ◀ , ▶ , ▲ or ▼ cursor arrows to place the box around the desired start or stop time for a given day.

Print

Access Level Required: VIEW

Generates a **Schedule** print report.

NAVIGATION

Home

Access Level Required: VIEW

Causes an instant return to the Home Screen.

Setup

Access Level Required: VIEW

Return to the previous setup screen.

USER SCREEN



FIG. 28

00366VIP

OVERVIEW

This screen allows definition of custom User ID's and matching passwords. This allows the building administrator to assign custom passwords to those who are authorized to maintain the chiller.

Each Custom User value is not linked to a specific button. Instead, the **Change** button is pressed which enables the cursor arrows which are used to highlight the Custom User parameter the user wishes to modify. At this point the '✓' (**Enter**) button is pressed and the value may be entered.

DISPLAY ONLY

None

PROGRAMMABLE

System Language

Access Level Required: OPERATOR

Allows the user to define the language for all Screens. The desired language is selected by scrolling through the list of those available. English is the Default language and is selected by pressing the ▲ key when the dialog box appears during the selection process. The selected language will not be displayed until after the user navigates from the USER Screen to another Screen.

English / Metric Units

Access Level Required: OPERATOR

Define the unit system (English or Metric) used by the chiller display.

Custom User ID (4)

Access Level Required: SERVICE

This allows the user to specify up to four (4) Custom User ID values. Each user ID will then require a corresponding Password and User Level. A User ID can be defined for various maintenance personnel. Service Technicians refer to YORK Service Manual 160.55-M1.

Custom User Password (4)

Access Level Required: SERVICE

This allows the user to specify up to four (4) Custom Password values. Each Password will then require a corresponding User ID and User Level. Service Technicians refer to YORK Service Manual 160.55-M1.

Custom User Access Level (4)

Access Level Required: SERVICE

This allows the user to specify up to four (4) Custom User Access Levels. Each Access Level will then require a corresponding Password and User ID. Service Technicians refer to YORK Service Manual 160.55-M1.

NAVIGATION

Home

Access Level Required: VIEW

Causes an instant return to the Home Screen.

Setup

Access Level Required: VIEW

Return to the Setup Screen.

**THIS PAGE INTENTIONALLY LEFT BLANK
TO MAINTAIN FORMAT**

COMMS SCREEN



FIG. 29

00478VIP

OVERVIEW

(Screen shown from Flash Memory Card version C.MLM.02.02.xxx and later. Screen layout from earlier versions slightly different)

This screen allows definition of the necessary communications parameters. Refer to PRINTER Section of this book for details of the Printer connections and setup. Presently, there are no COM 2 communications features available.

DISPLAY ONLY

None

PROGRAMMABLE**Chiller ID**

Access Level Required: OPERATOR

Define the numeric chiller ID when used within an ISN network of chillers. This ID number is also printed at the top of reports obtained with a local printer.

Printer Setup and COM 2 Setup

Access Level Required: OPERATOR

Pressing either key places a green selection box around the first changeable parameter. Use the ▲ and ▼ keys to place the selection box around the desired parameter to be changed. With the selection box around the desired parameter, press the ENTER (✓) key. A dialog box is displayed permitting data entry.

Printer Baud Rate

Define the baud rate at which the panel shall communicate to the printer.

Printer Data Bit(s)

Define the number of data bits with which the panel shall communicate to the printer.

Printer Parity Bit(s)

Define the number of parity bits with which the panel shall communicate to the printer.

Printer Stop Bit(s)

Define the number of stop bits with which the panel shall communicate to the printer.

COM 2 Baud Rate

Define the baud rate at which the panel shall communicate through the modem port.

COM 2 Data Bit(s)

Define the number of data bits at which the panel shall communicate through the modem port.

COM 2 Parity Bit(s)

Define the number of parity bits at which the panel shall communicate through the modem port.

COM 2 Stop Bit(s)

Define the number of stop bits at which the panel shall communicate through the modem port.

Setup

Access Level Required: VIEW
Return to the Setup Screen.

NAVIGATION**Home**

Access Level Required: VIEW

Causes an instant return to the Home Screen.

PRINTER SCREEN



FIG. 30

00368VIP

OVERVIEW

This screen allows definition of the necessary communications parameters for the printer. Refer to PRINTER section of this book for details of the Printer connections and setup.

DISPLAY ONLY

Time Remaining Until Next Print

Displays the time until the next print log will occur, if the function is enabled.

PROGRAMMABLE

Log Start Time

Access Level Required: OPERATOR

Set the time at which scheduled print logs will begin.

Output Interval

Access Level Required: OPERATOR

Define the interval at which log printing will occur.

Automatic Printer Logging (Enabled / Disabled)

Access Level Required: OPERATOR

Enable the printer to begin printing status reports beginning at the programmed start time and recurring at the interval defined above.

Printer Type

Access Level Required: OPERATOR

Define the printer type connected to the chiller system.

ACC Auto Map Print (Enabled / Disabled)

Access Level Required: SERVICE

Only available if the chiller system utilizes a Variable Speed Drive motor controller. The chiller monitors the ACC communications and when a surge point is mapped, a short report of system parameters is printed. *When this function is active, all other printing capability is disabled.*

ACC Map Report

Access Level Required: SERVICE

Only available if the chiller system utilizes a Variable Speed Drive motor controller. The chiller requests the entire surge map from the ACC. As the map is received, the parameters for each point are printed.

Print Report

Access Level Required: OPERATOR

Select the report type to print when the Print Report key is selected. This can vary from Status report (present system parameters), Setpoints report (present value of the system setpoints), Schedule report (present value of the system schedule times) or a Sales Order Data report (information provided on the Sales Order screen). A print report is generated upon completion of selection.

Print All Histories

Access Level Required: OPERATOR

Generate a report of the system data at the time of all stored shutdowns.

NAVIGATION

Home

Access Level Required: VIEW

Causes an instant return to the Home Screen.

Setup

Access Level Required: VIEW

Return to the Setup Screen.

SALES ORDER SCREEN

FIG. 31

00369VIP

OVERVIEW

This screen allows definition of the sales order parameters. The Commissioning date is entered by the YORK Service Technician at the time of chiller commissioning. These values should never be changed or entered by anyone other than a qualified Service Technician. Entry instructions are included in the YORK Service Manual 160.55-M1. The remainder of the values are entered at the YORK Factory during the manufacturing of the chiller.

DISPLAY ONLY**Model Number**

Factory defined model number of the chiller system.

Panel Serial Number

Factory defined serial number for the micropanel.

Chiller Serial Number

Factory defined serial number for the chiller system.

YORK Order Number

Factory defined order number under which the chiller was sold.

System Information

Factory defined conditions for which the chiller was originally rated and sold.

Condenser and Evaporator Design Load Information

Factory defined description of the condenser and evaporator configuration at time of shipment.

Nameplate Information

Factory defined information about the chiller motor configuration.

PROGRAMMABLE**Commissioning Date**

Access Level Required: SERVICE

Define the date at which the chiller was commissioned.

Job Name and Location

Access Level Required: SERVICE

Factory defined job name and location the chiller is destined for.

Print

Access Level Required: VIEW

This generates a listing of the Sales Order data

NAVIGATION**Home**

Access Level Required: VIEW

Causes an instant return to the Home Screen.

Setup

Access Level Required: VIEW

Return to the Setup Screen.

**THIS PAGE INTENTIONALLY LEFT BLANK
TO MAINTAIN FORMAT**

OPERATIONS SCREEN

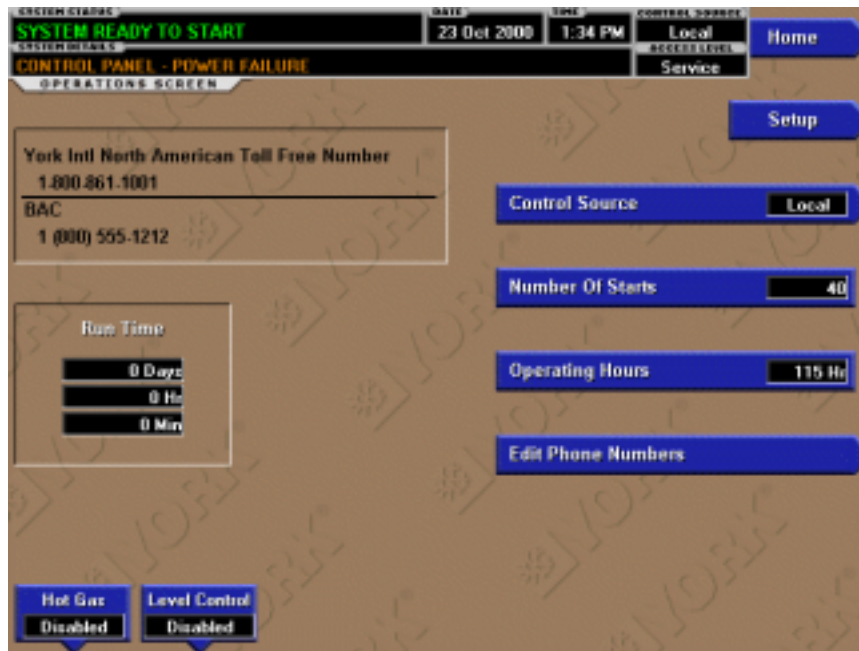

FIG. 32

00479VIP

OVERVIEW

This screen allows definition of general parameters having to do with the operation of the chiller.

DISPLAY ONLY

Chiller Run Time

(Flash memory Card version C.MLM.02.01 or later)

Displays the amount of time the chiller has been running since the last start signal was received. Value is reset to zero when the chiller enters Coastdown. It remains at zero while shutdown and during “System Prelube”.

PROGRAMMABLE

Control Source

Access Level Required: OPERATOR

Define whether the control of the chiller will be Local, Digital Remote, Analog Remote, Modem Remote or ISN Remote.

Number of Starts

Access Level Required: ADMIN

Displays the number of the starts the chiller has initiated. This may be reprogrammed to a desired value, (generally when this value has been reset due to a Microboard replacement), but should not be done so arbitrarily.

Operating Hours

Access Level Required: ADMIN

Displays the total accumulated run time of the chiller. This may be reprogrammed to a desired value (generally when this value has been reset due to a Microboard replacement), but should not be done so arbitrarily.

Hot Gas Bypass (Enabled/Disabled)

Access level required: SERVICE

Enables and disables the hot gas bypass feature.

Refrigerant Level Control (Enabled/Disabled)

Access Level Required: SERVICE

Enables and Disables the Refrigerant Level Control feature.

Service Phone Numbers

(Flash Memory Card version C.MLM.02.02.xxx and later)

Access Level Required: SERVICE

Displays up to two service phone numbers. The Regional service phone number is displayed as the first number. Although the label and number can be changed appropriately, the default for this entry is “York Intl North American Toll Free Number 1-800-861-1001”. The Local service phone number is displayed as the second number. Although blank by default, the appropriate label and number can be entered by a Service Technician. Service Technicians refer to Service Manual 160.55-M1.

NAVIGATION

Home

Access Level Required: VIEW

Causes an instant return to the Home Screen.

Setup

Access Level Required: VIEW

Return to the Setup Screen.

HISTORY SCREEN

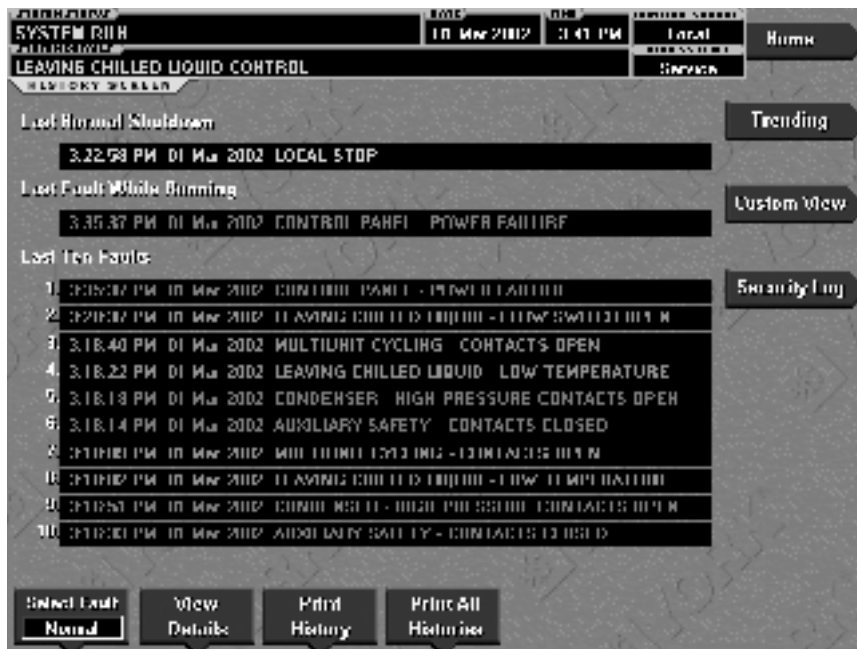

FIG. 33

00565VIP

OVERVIEW

This screen allows the user to browse through the faults. In order to get a more thorough reporting of the system conditions at the time of the recorded shutdown, move to the subscreen **HISTORY DETAILS**.

The user may use the **Select Fault** button to select the history to view. At this point the **View Details** button is used to jump to a subscreen containing stored chiller parameters values at the time of the shutdown. Additionally, the **Print History** button can be used to generate a hard-copy report of the parameter values at the time of the shutdown.

DISPLAY ONLY

Last Normal Shutdown

This window displays the date and time and the description of the last normal shutdown. A normal shutdown is defined as:

- Local (Panel rocker switch)
- Remote (Digital, Analog or ISN)

Last Fault While Running

This window displays the date and time and the description of the last safety or cycling shutdown while the system was running.

Last Ten Faults

This window displays a chronological listing (most recent first) of the date and time and the description of the last ten safety or cycling shutdowns that occur while the system is running or stopped.

PROGRAMMABLE

Print History

Access Level Required: VIEW

This generates a report listing the status of the chiller parameters at the time of the selected shutdown.

Print All Histories

Access Level Required: VIEW

This generates a report listing the status of the chiller parameters at the time of each of the stored shutdowns.

NAVIGATION

Home

Access Level Required: VIEW

Causes an instant return to the Home Screen.

View Details

Access Level Required: VIEW

Causes a move to a subscreen containing the value of select chiller parameters at the time of the associated shutdown.

Trending

Access Level Required: VIEW

Causes a move to a subscreen allowing the user to view trending data on selected chiller parameters.

Custom View

(Flash memory Card version C.MLM.02.01 or later)

Access Level required: VIEW

Causes a move to a sub-screen allowing the user to view the Custom Setup Screen.

Security Log

(Flash Memory Card version C.MLM.02.03.xxx and later)

Access Level Required: SERVICE

Causes a move to a sub-screen allowing the user to view a record of the last 75 setpoint changes.

HISTORY DETAILS SCREEN

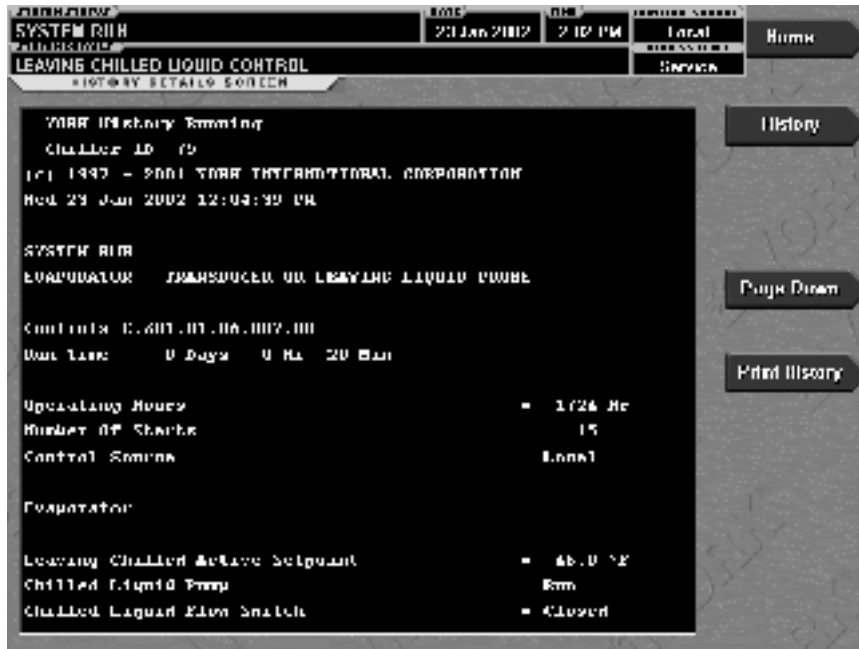

FIG. 34

00566VIP

OVERVIEW

This screen allows the user to see an on-screen printout of all the system parameters at the time of the selected shutdown. Not all screens are shown above. Number of screens required to display all of the data varies according to type of motor starter and options applied.

DISPLAY ONLY

History Printout

This is the on-screen printout of the system parameters.

PROGRAMMABLE

Page Up

Access Level Required: VIEW

Scroll up in the displayed data (if applicable).

Page Down

Access Level Required: VIEW

Scroll down in the displayed data (if applicable).

Print History

Access Level Required: VIEW

This generates a report listing the status of the chiller parameters at the time of the selected shutdown.

NAVIGATION

Home

Access Level Required: VIEW

Causes an instant return to the Home Screen.

History

Access Level Required: VIEW

Causes a return to the History Screen.

SECURITY LOG SCREEN

Category	Setpoint	New Value	History
1 Printer	Automatic Printer Logging	Disabled	
2 Motor	Local Motor Current Limit	100 %	
3 Motor	Pulldown Demand Limit	80 %	
4 Motor	Pulldown Demand Time	0 Min	
5 System	Heating Analog Input Range	2-10 Volts	
6 Evaporator	Heated Oilheat	5 1/2"	
7 Evaporator	Shutdown Oilheat	5 1/2"	
8 Printer	Printer Type	Lpson	
9 Printer	Output Interval	180 Min	
10 Printer	Log Start Time	10:00 PM	
11 Printer	Automatic Printer Logging	Enabled	
12 Motor	Pulldown Demand Time	5 Min	
13 Motor	Pulldown Demand Time	15 Min	
14 Motor	Pulldown Demand Limit	50 %	
15 Motor	Local Motor Current Limit	100 %	

FIG. 35

00563VIP

OVERVIEW

(This screen only available with Flash Memory Card version C.MLM.02.03.xxx and later)

This screen displays a listing of the last 75 setpoint changes. They are listed and numbered in reverse order in which they were changed, with the most recent listed as number 1. Multiple pages are necessary to display all 75 changes. Not all setpoints are logged. Service technicians refer to list in YORK Service Manual 160.55-M1.



Requires a login access level of SERVICE.

DISPLAY ONLY

Category

Displays the category of the setpoint (motor, evaporator, condenser, etc.)

Setpoint

Displays the setpoint that was changed.

New Value

Displays the value that was entered at the time of the setpoint change.

PROGRAMMABLE

Log Entry

Allows the user to select a particular setpoint change for detail viewing.

Print

Generates a detailed report of all setpoint changes listed in the setpoint change log.

Page Up

Scroll up in the displayed data (if applicable).

Page Down

Scroll down in the displayed data (if applicable).

NAVIGATION

Home

Access Level Required: SERVICE

Causes an instant return to the Home Screen.

History

Access Level Required: SERVICE

Causes an instant return to the History Screen.

View Details

Access Level Required: SERVICE

Causes a move to a sub-screen containing the details of the setpoint change selected with the Log Entry key.

SECURITY LOG DETAILS SCREEN

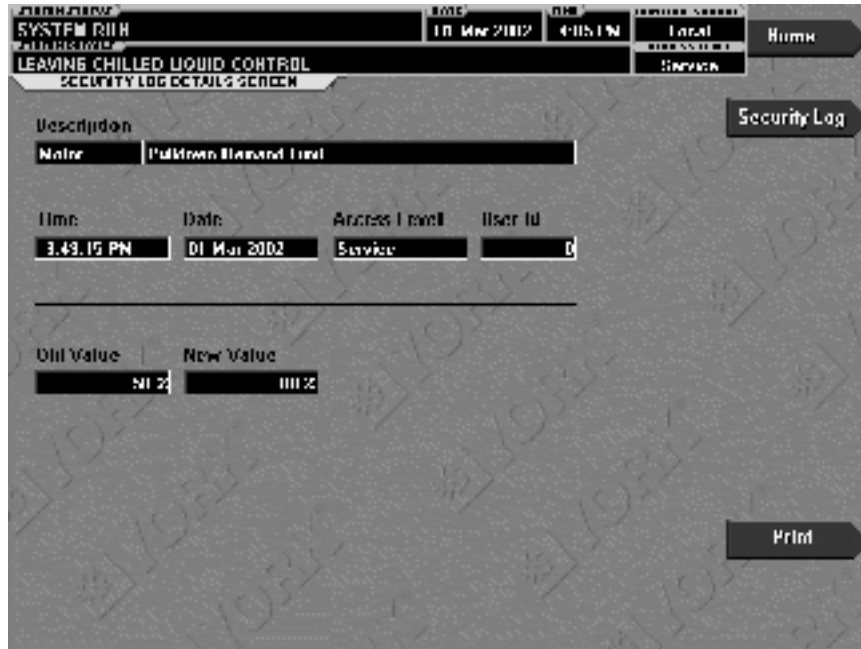

FIG. 36

00564VIP

OVERVIEW

(This screen only available with Flash Memory Card version C.MLM.02.03.xxx and later)

This screen allows the user to view the details of a logged setpoint change, selected from the list on the Security Log Screen. The date and time the setpoint was changed, the new and old setpoint value and access level and user ID used to make the change are displayed. The data on this screen can be printed.

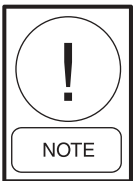

Requires a login access level of SERVICE.

DISPLAY ONLY

Description

Displays the setpoint/category that was changed.

Time

Displays the time the setpoint was changed.

Date

Displays the date the setpoint was changed.

Access Level

Displays the Login Access Level used to make the setpoint change.

User ID

Displays the Login User ID used to make the setpoint change.

Old Value

Displays the previous setpoint value.

New Value

Displays the value entered at the time of the setpoint change.

PROGRAMMABLE

Print

Generates a report of change parameters displayed on this screen.

NAVIGATION

Home

Access Level Required: SERVICE

Causes an instant return to the Home Screen.

Security Log

Access Level Required: SERVICE

Causes an instant return to the Security Log Screen.

View Details

Access Level Required: SERVICE

Causes a move to a sub-screen containing the details of the setpoint change selected with the Log Entry key.

TREND SCREEN



FIG. 37

00480VIP

OVERVIEW

As many as six Operator selected parameters (Data Points) can be plotted in an X/Y graph format. The X-Axis is scaled per the selected Data Collection Interval and displayed in a time of day or elapsed time format, as selected with the X-axis toggle key. The Y-Axis is scaled for each parameter per the selected minimum and maximum value for each parameter. Analog parameters are scaled in pressure, temperature, volts, amps, hertz or time. Digital on/off parameters are scaled as zero (off) and one (on). Only one Y-Axis label is displayed at a time. The Y-Axis Toggle Key is used to toggle the Y-Axis labels through the different parameters. The Y-Axis label that is being displayed is identified at the top of the graph. For identification, each plotted parameter and associated Y-Axis labeling is color coordinated.

With Flash Memory Card version C.MLM.02.01.xxx and earlier, all trended Data Points are displayed simultaneously. With Flash Memory Card version C.MLM.02.02.xxx and later, the DATA SELECT key is used to display all trended Data Points simultaneously or select a single Data Point for display.

The parameters are sampled at the selected Data Collection Interval and plotted using 450 data points across the X-Axis. If the actual value of the sampled parameter is less than the Y-Axis label minimum for that parameter, the value will be plotted at the minimum value. Simi-

larly, if the actual value is greater than the Y-Axis label maximum for that parameter, the value will be plotted at the maximum value.

There are three types of charts that can be created: **ONE SCREEN**, **CONTINUOUS** or **TRIGGERED** (not applicable to Flash Memory Card version C.MLM.02.01.xxx and earlier). When plotting reaches the end of the X-axis, if **ONE SCREEN** is selected, trending stops and data is frozen. If **CONTINUOUS** is selected, the oldest data is dropped from the left-hand side of the graph at the next collection interval. Thereafter, the oldest data is dropped from the left hand-side of the graph at each data collection interval. If **TRIGGERED** is selected, data collection can be set to start or stop based upon the selected **TRIGGER ACTION** (**START** or **STOP**). If **START** is selected, data collection will not begin until the Triggers have been satisfied and any selected **TRIGGER DELAY** has elapsed. Data collection will stop at the completion of one screen of data as with the **ONE SCREEN**. If **STOP** is selected, data collection will not stop until the Triggers have been satisfied and any selected **TRIGGER DELAY** has elapsed.

If a power failure occurs while the trending is running, the trending is stopped. Upon restoration of power, the last screen of data that was collected will be displayed on the trending screen. The **START** key must be pressed to initiate a new trend screen.

DISPLAY ONLY

This screen allows the user to view the graphical trending of the selected parameters and is also a gateway to the graph setup screens.



A red screen with the words “TREND MAX MUST BE > TREND MIN” will appear if the Y-Axis minimum has been programmed to a value that is greater than the Y-Axis maximum for any parameter. If this appears, proceed to the Trend Setup Screen to change the values.

PROGRAMMABLE

Start

Access Level Required: OPERATOR

Pressing this key clears the graph, starts a new graph, sets the time of day to the present clock time and begins the trending. This key is only available if trending is stopped. If the selected Chart Type is TRIGGERED and TRIGGER ACTION is set to START, data collection will not begin until the Triggers have been satisfied and any selected TRIGGER DELAY has elapsed. Otherwise, data collection will begin immediately.

Stop

Access Level Required: OPERATOR

Pressing this key stops the trending. The trend data is frozen on the display until another graph is started with the START key. The STOP key is only available if trending is running.

Data Select

(Flash Memory Card version C.MLM.02.02.xxx and later)

Access Level required: VIEW

Allows the user to display all trended data points simultaneously or select a single trended data point for display, hiding the other data points. Selections are ALL DATA or DATA POINT X (1-6).

Print

(Flash Memory Card version C.MLM.02.02.xxx and later)

Access Level Required: VIEW

Allows the data on the trend screen to be printed in tabular format. If set to EXISTING, a snapshot of the data presently on the screen is sent to the printer. If set to NEW, all data collected after pressing this key will be sent to the printer as it is collected. If set to DISABLED, no data is sent to the printer. Refer to PRINTERS section of this book for printout example.

Y-Axis

Access Level Required: VIEW

This key toggles the Y-Axis labels of the graph. Each key press changes the label to another of the selected parameters.

X-Axis

Access Level Required: VIEW

This key toggles the X-Axis labels of the graph. Each key press alternates the scaling between time of day and elapsed time. The Time of Day scaling is in 24-hour format. The Elapsed Time scaling is the time elapsed since the START key was pressed, starting the trending.

NAVIGATION

Home

Access Level Required: VIEW

Causes a return to the Home Screen.

History

(Flash memory Card version C.MLM.02.01.xxx and earlier)

Access Level Required: VIEW

Causes a return to the Home Screen.

Trend Setup

Access Level Required:

Only displayed if the trending is stopped. Causes a jump to a subscreen for configuring the trending display.

TREND SETUP SCREEN

System	Date	Time	Control Source
SYSTEM RUN	23 Oct 2008	1 57 PM	Local
LEAVING CHILLED LIQUID CONTROL			Service

Data Point	Slot	Parameter	Minimum	Maximum
Data Point 1		Leaving Chilled Liquid Temperature	0.0 °F	82.0 °F
Data Point 2		Water Run	Off	On
Data Point 3		Not Assigned		
Data Point 4		Not Assigned		
Data Point 5		Not Assigned		
Data Point 6		Not Assigned		

Press Select button to start programming. Use cursor keys to select desired parameter. Press Enter key to input parameter.

FIG. 38

00481VIP

OVERVIEW

This screen is used to configure the trending screen. The parameters to be trended are selected from the Common Slots Screen or Common Slots Master list and entered as Slot Numbers for Data Points 1 through 6. The Y-Axis minimum and maximum values for each parameter are entered as Data Point Min and Data Point Max for Data Points 1 through 6. The interval at which all the parameters are sampled is selected as the Data Collection Interval.

DISPLAY ONLY

None

PROGRAMMABLE**Chart Type**

Access Level Required: OPERATOR
(Flash Memory Card version (C.MLM.02.02.xxx and later) Selects CONTINUOUS, ONE SCREEN or TRIGGERED type of graph.

Collection Interval

Access Level Required: OPERATOR
Selects the interval at which the parameters are sampled. There are 450 data points displayed across the X-Axis

of the graph. Each point represents the instantaneous value of the parameter. The user selects the time interval between these points. This is called the DATA COLLECTION INTERVAL or the interval at which the parameter is sampled. This interval is programmable over the range of 1 second to 3600 seconds (1 hour), in one second increments. The selected interval not only determines the sample interval, but also the full screen time display. The full screen time display is a result of the selected interval in seconds, multiplied by the 450 data points. For example, if the **Data Collection Interval** is programmed for 900 seconds, the parameter would be sampled every 900 seconds, with the last 112.5 hours (4.7 days) of data viewable on the screen. Therefore, the selected interval is a compromise between resolution and full screen time display. Select the desired **Data Collection Interval** as follows:

1. Determine the desired time interval (in seconds), between data samples.
2. Calculate the full screen time display as follows:
 $450 \times \text{Data Collection Interval} = \text{full screen seconds}$
 $\text{full screen seconds} / 60 = \text{full screen minutes}$
 $\text{full screen minutes} / 60 = \text{full screen hours}$
 $\text{full screen hours} / 24 = \text{full screen days}$
3. Decide if the resultant sample interval and full screen display meet the requirements. If not, select a different sample interval.

Select

Access Level Required: OPERATOR

This key is used to enter the slot numbers and the minimum and maximum Y-Axis values of each parameter to be trended. Pressing this key places a yellow box around Data Point 1 Slot Number. Use the ▲ and ▼ navigation keys to place the box around the value of Data Points 1 through 6 to be changed. With the desired value selected, press the ✓ key. A dialog box is displayed permitting data entry.

Data Point Slot # (1-6)

Access Level Required: OPERATOR

Use the SELECT key as described above and enter the slot number from the Common Slots Screen or Master Slot Number List of the desired parameter to be trended. The selected parameter description will be displayed for the Data Point. Setting this slot number to zero will disable trending for that particular Data Point. Any or all points can be disabled.

Data Point Min (1-6)

Access Level Required: OPERATOR

Only displayed if the Associated Slot Number is not Zero. This is the minimum value displayed for the Y-Axis. Selecting a parameter for a Data Point sets this to the default value, which is the lowest value allowed for that parameter. It can be changed to a value that provides a more appropriate resolution for the parameter being monitored. To change, use the SELECT key as described above and enter the desired value. The value must always be set to a value less than the Data Point Max. Otherwise, a red graph is displayed on the Trend Screen with the words “TREND MAX MUST BE > TREND MIN”. If the parameter selected for this data point is a digital type (on/off), this value must be set to zero (0). Zero indicates the OFF state.

Data Point Max (1-6)

Access Level Required: OPERATOR

Only displayed if the associated slot number is not zero. This is the maximum value displayed for the Y-Axis.

Selecting a parameter for a Data Point sets this to the default value, which is the highest value allowed for that parameter. It can be changed to a value that provides a more appropriate resolution for the parameter being monitored. To change, use the SELECT key as described above and enter the desired value. The value must always be set to a value greater than the Data Point Min. Otherwise, a red graph is displayed on the Trend Screen with the words “TREND MAX MUST BE > TREND MIN”. There are 20 Y-Axis divisions. If a MIN-MAX span is selected that is not evenly divided by 20, the Program will automatically select the next higher MAX value that makes the span evenly divided by 20. For example, if 0.0 is selected as the MIN and 69.0 is selected as the MAX, the Program will insert 70.0 as the MAX value. If the parameter selected for this data point is a digital type (on/off), this value must be set to one (1). One indicates the on state.

NAVIGATION**Home**

Causes a return to the Home Screen.

Trending

Causes a return to the Trending Screen.

Slot Numbers

Causes a jump to a subscreen that lists the slot numbers of the most commonly monitored parameters. The desired parameters to be plotted are selected from this screen.

Triggers

(Flash Memory Card version C.MLM.02.02.xxx and later)

Causes a jump to the Advanced Trend Setup Screen, where the start/stop Triggers can be setup. Only displayed if TRIGGERED has been selected as Chart Type.

ADVANCED TREND SETUP SCREEN



FIG. 39

00484VIP

OVERVIEW

(Flash Memory Card version C.MLM.02.02.xxx and later)

The desired data collection start/stop triggers are setup on this screen. The trend data collection can be set to start or stop based upon the status of up to two selected Triggers. The Triggers can consist of digital events or analog parameters compared to thresholds. The Triggers can be used individually or in combination. The digital and analog parameters are selected from the Common Slots Screen (or Master Slot Numbers List in this book).

The parameter selected as the Primary Trigger is compared to a value selected as the Primary Test, using the Primary Operator as a comparator. If it is evaluated as true, then the data collection is started or stopped (after any selected Trigger delay) per the selected Trigger Action.

A Secondary Trigger can be evaluated with the Primary Trigger to start/stop data collection. The Primary to Secondary Operator is used to define the Trigger combinations required to be true to start/stop data collection. The Secondary Trigger is setup and evaluated the same as the Primary Trigger.

Entry fields are as follows:

If Primary Trigger

Is Primary Operator Primary Test

Primary to Secondary Operator

Secondary Trigger

Is Secondary Operator Secondary Test

Then Trigger Action the Data Collection

With a delay of Trigger Delay

After the desired Triggers are set, the START key on the TREND Screen must be manually pressed before the triggers will be evaluated. While waiting for the triggers to start or stop data collection, a status message is displayed in the upper right corner of the TREND Screen describing the pending action.

DISPLAY ONLY

None

PROGRAMMABLE

Primary Trigger

Access Level Required: OPERATOR

Selects the first parameter to be evaluated. Selection is made from the Slot Numbers listing on the Trend Common Slots Screen or the Master Slot Numbers List in this book. Setting this slot number to zero disables the Primary Trigger.

Primary Operator

Access Level Required: OPERATOR

Selects the comparator for the Primary Trigger's relationship to the Primary Test. If the Primary Trigger is an analog value, selections are: <, <=, =, =>, >. If the Primary Trigger is a digital event, selections are: Equal To, Not Equal To.

Primary Test

Access Level Required: OPERATOR

Selects the value or condition that the Primary Trigger is compared to. Selection ranges from the Primary Trigger minimum value to the Primary Trigger maximum value.

Trigger Action

Access Level Required: OPERATOR

Selects whether the trend data collection will Start or Stop when the Trigger comparisons are true. If set to Start, data collection will stop after one screen of data is collected.

Trigger Delay

Access Level Required: OPERATOR

Allows the data collection start or stop to be delayed after the Triggers evaluate as true. The delay is selectable from 1 to 864000 seconds (10 days). Display is in days, hours, minutes and seconds. The delay timer begins when the triggers evaluate as true. If the Trigger Action is set to Start, data collection will begin after the triggers evaluate as true and the delay timer has elapsed. If the Trigger Action is set to Stop, data collection will stop after the Triggers evaluate as true and the delay timer has elapsed.

Primary to Secondary Operator

Access Level Required: OPERATOR

Selects whether the Primary Trigger, Secondary Trigger or both have to be true in order to start or stop data collection. Selections are AND, OR, XOR and None. If NONE is selected, the Secondary Trigger is disabled.

Data collection will start/stop (as selected with Trigger Action) when:

- If AND selected: Both Primary AND Secondary are true
- If OR selected: Either Primary OR Secondary (or both) are true
- If XOR selected: Either Primary OR Secondary (but not both) are true

Secondary Trigger

Access Level Required: OPERATOR

Selects the second parameter to be evaluated. Selection is made from the Slot Numbers listing on the Trend Common Slots Screen or the Master Slot Numbers List in this book. Setting this slot number to zero disables the Secondary Trigger.

Secondary Operator

Access Level required: OPERATOR

Selects the comparator for the Secondary Trigger's relationship to the Secondary Test. If the Secondary trigger is an Analog value, selections are: <, <=, =, =>, >. If the Secondary Trigger is a digital event, selections are: Equal To, Not Equal To.

Secondary Test

Access Level Required: OPERATOR

Selects the value or condition that the Secondary Trigger is compared to. Selection ranges from the Secondary Trigger minimum to the Secondary Trigger maximum.

NAVIGATION

HOME

Causes an instant return to the Home Screen.

TREND SETUP

Causes an instant return to the Trend Setup Screen.

COMMON SLOTS SCREEN



FIG. 40

00374VIP

OVERVIEW

This screen displays the slot numbers of the commonly monitored parameters. The slot numbers for the remainder of the available parameters are listed on the Master Slot Numbers List that follows.

From these lists, select up to six parameters to be trended. Return to the Trend Setup Screen and enter the parameters Slot Numbers into Data Points 1 through 6.

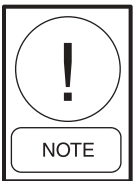

Requires a login access level of OPERATOR or higher.

DISPLAY ONLY

Slot Numbers

These are the slot numbers of the most commonly used parameters.

PROGRAMMABLE

Page Down

Access Level required: OPERATOR
Scroll down in the displayed data.

Page Up

Access Level Required: OPERATOR
Scroll up in the displayed data.

Print

Access Level Required: OPERATOR
Generates a list of the slot numbers of the available parameters.

NAVIGATION

Home

Causes an instant return to the Home Screen.

Trend Setup

Causes a return to the Trend Setup Screen.

CUSTOM VIEW SCREEN

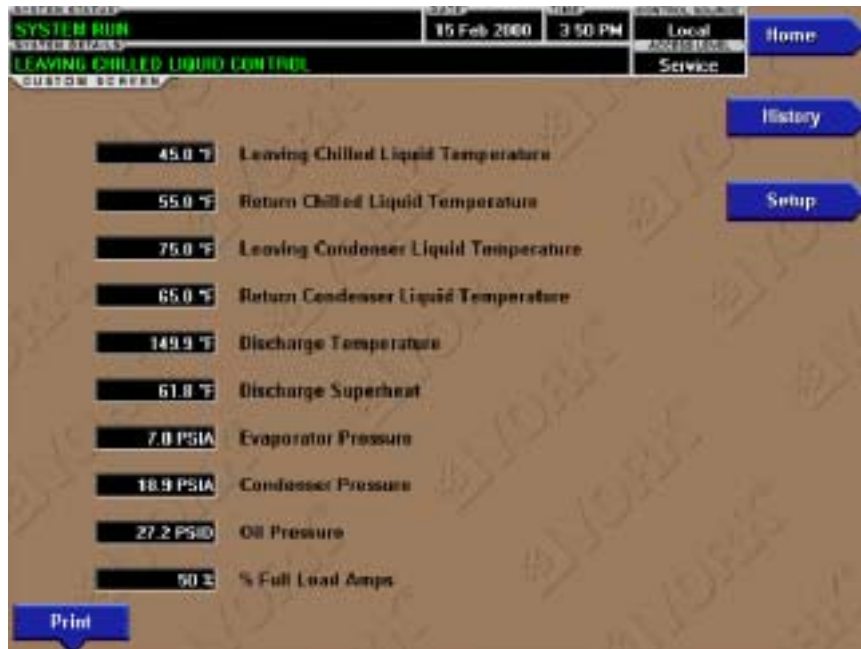

FIG. 41

00375VIP

OVERVIEW

(Flash memory Card version C.MLM.02.01 or later)

This screen allows up to 10 Service Technician selected parameters to be displayed. These parameters are selected from a list on the Custom View Setup Screen. This allows the Service Technician to display parameters pertinent to a particular problem during troubleshooting. At completion of the service call, the display can be cleared or the parameters can be left there for monitoring by operations personnel.

DISPLAY ONLY

None

PROGRAMMABLE

Print

Access Level Required: VIEW

This generates a listing of the parameters displayed on this screen.

NAVIGATION

Home

Access Level Required: VIEW

Causes an instant return to the Home Screen.

History

Access Level required: VIEW

Causes an instant return to the History Screen.

Setup

Access Level required: SERVICE

Causes a jump to the sub-screen that allows selection of the parameters to be displayed.

CUSTOM VIEW SETUP



FIG. 42

00376VIP

OVERVIEW

(Flash memory Card version C.MLM.02.01 or later)

This screen allows the Service technician to select up to 10 parameters for display on the Custom View Screen.



*Requires a login access level of **SERVICE**. Service Technicians refer to **YORK Service Manual 160.55-M1** for operation instructions and explanation of all programmable setpoints and displayed values.*

DISPLAY ONLY

Slot Numbers

Lists the available parameters that can be displayed. The desired parameters for display are selected from this list.

PROGRAMMABLE

Page Up

Scroll up through list of available parameters.

Page Down

Scroll down through list of available parameters.

Select

First use the Page Up and Page Down keys to scroll

through the Slot Numbers list and note the number of the parameter(s) to be displayed. Pressing the Select key places a green colored selection box around Custom Slot 1. If it is desired to change an already entered parameter, use the 5 and 6 keys to place the selection box around the slot number to be changed. With the selection box around the slot number to be changed or entered, press the ENTER (✓) key. A dialog box is displayed permitting data entry. Using the numeric keypad keys, enter the desired slot number and press the ENTER (✓) key.

Custom Slot (1-10)

Use the Select key and numeric keypad keys as described above and enter the slot number from Slot Numbers list. Setting the Slot number to zero clears the display of this slot number.

Clear Display

Pressing this key clears all selected parameters from the Custom View screen.

NAVIGATION

Home

Access Level Required: VIEW

Causes a return to the Home Screen.

Custom View

Access Level Required: SERVICE

Causes a return to the Custom View Screen.

MASTER SLOT NUMBERS LIST FOR USE WITH TREND FEATURE

SLOT NO.	DESCRIPTION
256	System: Chiller State
257	System: Coastdown Time Remaining
258	System: Prelube Time Remaining
259	System: Are Safety Shutdown Contacts Closed
260	System: Are Cycling Shutdown Contacts Closed
261	System: Are Anticipatory Alarm Contacts Closed
262	System: Operating Hours
264	System: Number of Starts
265	System: Is Stop Switch Closed
266	System: Is Start Switch Closed
267	System: Is Remote Ready to Start
280	External Contact: Is Remote Stop Closed
281	External Contact: Is Remote Start Closed
282	External Contact: Is MultiUnit Cycling Closed
283	External Contact: Is Remote Cycling Closed
284	External Contact: Is Auxiliary Safety Open
285	Jumper: Is Anti-Recycle Enabled
286	Jumper: Coastdown Operation
287	Jumper: Is Diagnostics Enabled
288	Jumper: Liquid Type
289	Jumper: Chilled Liquid Pump Operation
290	Jumper: Motor Type
291	Jumper: Power Failure Restart
292	Jumper: Pre-Run Operation
293	Jumper: Refrigerant Selection
294	Jumper: VSD Motor Supply Line Frequency
304	Options: Control Mode
305	Options: System Language
307	Options: Display Mode
512	Sched: Is Schedule Enabled
1280	Pre-Rotation Vanes: Is Motor Switch Closed
1281	Pre-Rotation Vanes: Position
1282	Pre-Rotation Vanes: Are Vanes Opening
1283	Pre-Rotation Vanes: Are Vanes Closing
1284	Pre-Rotation Vanes: Are Vanes Holding
1285	Pre-Rotation Vanes: Control Mode
1296	Discharge: Temperature
1536	Oil: Differential Pressure
1537	Oil: Sump Temperature
1538	Oil Pump: Control Mode
1539	Oil Pump: Is Pump On
1540	Oil Pump: Manual Time Left

SLOT NO.	DESCRIPTION
1792	Leaving Chilled Liquid: Temperature
1793	Leaving Chilled Liquid: Temperature Differential
1794	Leaving Chilled Liquid: Is Flow Switch Closed
1795	Leaving Chilled Liquid: Is Pump On
1796	Leaving Chilled Liquid: Local Temperature Setpoint
1797	Leaving Chilled Liquid: Remote Analog Temperature Setpoint
1798	Leaving Chilled Liquid: Remote ISN Temperature Setpoint
1799	Leaving Chilled Liquid: Remote Modem Temperature Setpoint
1800	Leaving Chilled Liquid: Selected Temperature Setpoint
1801	Leaving Chilled Liquid: Control Sensitivity
1802	Leaving Chilled Liquid: Remote Temperature Range
1803	Leaving Chilled Liquid: Restart Temperature Offset
1804	Leaving Chilled Liquid: Restart Temperature Setpoint
1805	Leaving Chilled Liquid: Shutdown Temperature Offset
1806	Leaving Chilled Liquid: Shutdown Temperature Setpoint
1807	Return Chilled Liquid: Temperature
1808	Evaporator: Pressure
1809	Evaporator: Saturation Temperature
1810	Evaporator: Small Temperature Difference
1811	Evaporator: Is Refrigerant Sensor Present
1812	Evaporator: Refrigerant Temperature
1813	Evaporator: Delta P / P
1814	Evaporator: Brine Low Cutout
1815	Smart Freeze Protection: Is Control Enabled
1818	Leaving Chilled Liquid: Remote Digital Temperature Setpoint
2048	Leaving Condenser Liquid: Temperature
2049	Leaving Condenser Liquid: Is Flow Switch Closed
2050	Leaving Condenser Liquid: Is Pump On
2051	Return Condenser Liquid: Temperature
2052	Condenser: Pressure
2053	Condenser: Saturation Temperature
2054	Condenser: Small Temperature Difference
2057	Condenser: Is High Pressure Switch Closed
2058	Condenser: High Pressure Warning Threshold

SLOT NO.	DESCRIPTION
2059	SubCooling: Temperature
2060	Drop Leg Refrigerant: Is Sensor Present
2061	Drop Leg Refrigerant: Temperature
2063	Vent Line Solenoid: Is Solenoid On
2304	Motor: Starter Type
2305	Motor: Is Motor Starter On
2306	Motor: Current %FLA
2307	Motor: Is Motor Controller Switch Open
2308	Motor: Current Limit Local Setpoint
2309	Motor: Current Limit Remote Analog Setpoint
2310	Motor: Current Limit Remote ISN Setpoint
2312	Motor: Current Limit Selected Setpoint
2313	Motor: Pulldown Demand Time Remaining
2314	Motor: Pulldown Demand Limit Setpoint
2315	Motor: Pulldown Demand Time Setpoint
2316	Motor: Anti-Recycle Time Remaining
2317	Motor: Current Limit Remote Digital Setpoint
	Mod "A" SSS ONLY
2560	SSS: Phase A Current
2561	SSS: Phase B Current
2562	SSS: Phase C Current
2563	SSS: Phase A Voltage
2564	SSS: Phase B Voltage
2565	SSS: Phase C Voltage
2566	SSS: Scale/Model
2567	SSS: Full Load Amps
2568	SSS: Supply Voltage Range
2569	SSS: Is Current Unbalance Check Enabled
	Mod "B" SSS ONLY
2570	LcSss: Input Power
2571	LcSss: Kilowatt Hours
2572	LcSss: Phase A Current
2573	LcSss: Phase B Current
2574	LcSss: Phase C Current
2575	LcSss: Phase A Voltage
2576	LcSss: Phase B Voltage
2577	LcSss: Phase C Voltage
2578	LcSss: Phase A Temperature
2579	LcSss: Phase B Temperature
2580	LcSss: Phase C Temperature
2581	LcSss: Starter Model
2582	LcSss: Full Load Amps
2583	LcSss: Voltage Range
2584	LcSss: Starting Current
2585	LcSss: Is Serial Communications OK
2586	LcSss: Panel to Sss Comm Errors
2587	LcSss: Sss to Panel Comm Errors

SLOT NO.	DESCRIPTION
2816	VSD: Motor HP
2817	VSD: 100% Full Load Amps
2818	VSD: Input Power
2819	VSD: Kilowatt Hours
2820	VSD: DC Bus Voltage
2821	VSD: DC Inverter Link Current
2822	VSD: Output Frequency
2823	VSD: Output Voltage
2824	VSD: Phase A Current
2825	VSD: Phase B Current
2826	VSD: Phase C Current
2827	VSD: Is Precharge Relay On
2828	VSD: Is Trigger SCR On
2829	VSD: Is Water Pump On
2830	VSD: Control Mode
2831	VSD: Command Frequency
2832	VSD: Manual Frequency Increment
2833	VSD: Internal Ambient Temperature
2834	VSD: Converter Heatsink Temperature
2835	VSD: Phase A Heatsink Temperature
2836	VSD: Phase B Heatsink Temperature
2837	VSD: Phase C Heatsink Temperature
2838	VSD: Is Communications OK
2839	VSD: Panel to ACC Comms Error Count
2840	VSD: ACC to Panel Comms Error Count
2841	VSD: ACC to VSD Comms Error Count
2842	VSD: VSD to ACC Comms Error Count
2843	VSD: VSD to Filter Comms Error Count
2844	VSD: Filter to ACC Comms Error Count
2845	ACC: Delta P/P
2846	ACC: Stability Limit
2847	ACC: Surge Margin
2848	ACC: Manual Surge Command
2849	ACC: Surge Map Count
2850	ACC: Surge Type
2857	ACC: Surge Map Point Count
2858	ACC: Surge Map Delta P/P
2859	ACC: Surge Map Output Frequency
2860	ACC: Surge Map PRV Position
2861	Filter: Is Filter Installed
2862	Filter: Is Operation Inhibited
2863	Filter: Is Filter Running
2864	Filter: Is Precharge Contactor Closed
2865	Filter: Is Supply Contactor Closed
2866	Filter: Phase Rotation
2867	Filter: Motor HP
2868	Filter: Supply KVA
2869	Filter: Total Power Factor
2870	Filter: DC Bus Voltage

SLOT NO.	DESCRIPTION
2871	Filter: Heatsink Temperature
2872	Filter: L1 - L2 RMS Voltage
2873	Filter: L2 - L3 RMS Voltage
2874	Filter: L3 - L1 RMS Voltage
2875	Filter: L1 - N Peak Voltage
2876	Filter: L2 - N Peak Voltage
2877	Filter: L3 - N Peak Voltage
2878	Filter: L1 Total Harmonic Distortion
2879	Filter: L2 Total Harmonic Distortion
2880	Filter: L3 Total Harmonic Distortion
2881	Filter: L1 RMS Filter Current
2882	Filter: L2 RMS Filter Current
2883	Filter: L3 RMS Filter Current
2884	Filter: L1 RMS Supply Current
2885	Filter: L2 RMS Supply Current
2886	Filter: L3 RMS Supply Current
2887	Filter: L1 Total Demand Distortion
2888	Filter: L2 Total Demand Distortion
2889	Filter: L3 Total Demand Distortion
2890	Filter: Maximum Total Harmonic Distortion
2891	Filter: Maximum Total Demand Distortion

SLOT NO.	DESCRIPTION
8205	Refrigerant Level: Is Control Enabled
8206	Refrigerant Level: Position
8207	Refrigerant Level: Is Valve Closing
8208	Refrigerant Level: Is Valve Opening
8209	Refrigerant Level: Control Mode
8210	Refrigerant Level: Is Pulldown In Effect
8211	Refrigerant Level: Pulldown Time Remaining
8212	Refrigerant Level: Target Setpoint
8213	Refrigerant Level: Setpoint
8214	Refrigerant Level: Period
8215	Refrigerant Level: Proportional Limit Close
8216	Refrigerant Level: Proportional Limit Open
8217	Refrigerant Level: Rate Limit Close
8218	Refrigerant Level: Rate Limit Open
12288	Purge: Pressure
12289	Purge: Is Air Purge Valve Closed
12290	Purge: Is Oil Purge Valve Closed
12291	Purge: Is Bottom Float Switch Closed
12292	Purge: Is Top Float Switch Closed
12293	Purge: Exhaust Count
12294	Purge: Window Time
12295	Purge: Is High Efficiency Enabled
12296	Purge: Maximum Purges Per Hour

DISPLAY MESSAGES

The Status Bar of the Display contains a Status Line and, beneath it a Details Line. The Status Line contains a message describing the operating state of the chiller; whether it is stopped, running, starting or shutting down. The Details Line displays Warning, Cycling, Safety, Start Inhibit and other messages that provide further details of the Status Bar messages. The Status Messages listed below are displayed on the Status Line. All other messages are displayed on the Details Line.

To aid in the meaning of the message, messages are displayed in different colors as follows:

- Normal Operation messages - Green
- Warning messages - Yellow
- Cycling Shutdown messages - Orange
- Safety Shutdown messages - Red

STATUS MESSAGES

“SYSTEM READY TO START”

The chiller is shut down but will start upon receipt of a Local or Remote start signal.

“CYCLING SHUTDOWN – AUTO RESTART”

The chiller is shut down on a CYCLING shutdown. The cause of the shutdown is still in effect and is displayed on the Details line of the Status Bar. The chiller will automatically restart when the CYCLING condition clears.

“SAFETY SHUTDOWN – MANUAL RESTART”

The chiller is shut down on a SAFETY shutdown. The cause of the shutdown is still in effect and is displayed on the Details line of the Status Bar. The chiller can be started after the Safety condition clears and the Operator moves the COMPRESSOR switch to the STOP-RESET (O) position.

“SYSTEM PRELUBE”

A chiller start has been initiated and the pre-start lubrication is being performed. The Prelube duration is either 30 seconds or 180 seconds, as configured with a Microboard Program Switch. The Pre-lube duration must never be changed by anyone other than a qualified Service Technician. The standard Prelube duration is 30 seconds.

“SYSTEM RUN”

The chiller is running under the condition described in the Details Line of the Status Bar.

“SYSTEM COASTDOWN”

The chiller has shut down and the Post-run lubrication is being performed. On electric motor drive applications, the Postlube duration is 150 seconds. On Steam Turbine applications, it is 15 minutes. The actual duration is determined by a Microboard Program Jumper, configured by a qualified Service technician.

“START INHIBIT”

The chiller is prevented from being started due to the reason displayed on the Details Line of the Status bar.

RUN MESSAGES

“MOTOR – HIGH CURRENT LIMIT”

The Compressor Motor current is \geq the Local or Remote Current Limit Setpoint. The Current Limit Setpoint is programmed over a range of 30 to 100% of the Chiller Full Load Amps (FLA). When the motor current increases to the “inhibit open” threshold, the Pre-rotation Vanes are inhibited from further opening. This prevents a further current rise. If the current continues to rise to the “start close” threshold, the Vanes begin closing until the current falls to the “stop close” threshold. Automatic Vane operation is resumed and this message automatically clears when the motor current decreases to the “allow open” threshold. The thresholds are different for the various motor starter applications. To allow field calibration of the Solid State Starter (Mod “A”) Logic Board or CM-2 Current Module, pressing the Slide Valve Load key in Service access level, starts a 10 minute timer during which the current limit thresholds are elevated. Refer to table on next page.

Vane Control	Motor Current (%FLA)		
	Electro-Mechanical/ Solid state starter	VSD	Service Mode
On rise, inhibit open	100	100	107
On fall, allow open	98	98	106
On rise, start close	104	103	110
On fall, stop close	102	101	109

An example of current limit is as follows: If a Solid State Starter chiller FLA is 100 Amps and the Current Limit Setpoint is 50%, the following will occur:

- 50 Amps – inhibit vane open
- 52 Amps – vanes begin closing
- 51 Amps – vanes stop closing
- 49 Amps – allow automatic vane control

“LEAVING CHILLED LIQUID CONTROL”

The chiller is running, controlling the Leaving Chilled Liquid to the Leaving Chilled Liquid Temperature Setpoint. There are no system conditions inhibiting this operation.

“MOTOR PULLDOWN LIMIT”

The Pulldown Demand Limit Setpoint timer is in effect and the Compressor Motor current is \geq the Pulldown Demand Current Limit Setpoint value. The Pre-rotation vane operation is being inhibited as described in “MOTOR – HIGH CURRENT LIMIT” message above.

START INHIBIT MESSAGES**“ANTI-RECYCLE XXMin/Sec”**

The chiller is inhibited from starting because the 30 minute anti-recycle time has not yet elapsed. Time remaining is displayed.

“VANE MOTOR SWITCH OPEN”

The chiller is inhibited from starting because the Pre-rotation Vanes are not fully closed.

“MOTOR CURRENT >15% FLA”

The OptiView Control Center has detected a Compressor Motor Current of a magnitude that is $>15\%$ of the chiller Full Load Amps for 10 continuous seconds, while the chiller is shutdown. As long as this condition exists, the oil pump is turned on. This is generally indicative of a failure of the motor starter, Control Center start circuits or motor current feedback circuits. After motor current is no longer detected, a SYSTEM COASTDOWN is performed. The chiller can be started after motor current is no longer detected, the SYSTEM COASTDOWN has completed and the COMPRESSOR switch is placed in the STOP-RESET (O) position.

“LCSSS – HIGH TEMPERATURE PHASE X – STOPPED”

(Mod. “B” Solid State Starter only)

The chiller is stopped and the Liquid Cooled Solid State Starter Logic/Trigger Board has detected that the temperature of phase A, B or C (designated as X in the message) Silicon Controlled Rectifier (SCR) module is $>110^{\circ}\text{F}$. The starter cooling pump will run and the chiller will be inhibited from starting until the temperature decreases to $<109^{\circ}\text{F}$.

WARNING MESSAGES**“WARNING – REAL TIME CLOCK FAILURE”**

During the initialization process that occurs when power is applied to the OptiView Control Center, test data is written to a location in the BRAM battery backed memory device (IC location U52 on Microboard). This data is then read from the BRAM and compared to the test data. If the read data is not the same as that which was

written to the device, it is assumed the BRAM and Real time Clock operation is defective and this message is displayed. The BRAM should be replaced by a qualified Service Technician. This message automatically clears when the BRAM problem has been solved.

“WARNING – CONDENSER OR EVAPORATOR XDCR ERROR”

The Evaporator pressure Transducer is indicating a higher pressure than the Condenser pressure Transducer after the chiller has been running for 10 minutes. This is indicative of a Condenser or Evaporator Transducer failure. This message will be displayed until the condition clears and the WARNING RESET Keypad key is pressed on the home screen in OPERATOR (or higher) access mode. Condition not checked in Brine mode.

“WARNING – SETPOINT OVERRIDE”

A blank BRAM battery-backed memory device (IC location U52 on Microboard) or a failure of this device was detected during the initialization process that occurs when power is applied to the OptiView Control Center. Due to this failure, any or all of the programmed Setpoints could have been corrupted. Therefore, all Setpoints have been automatically changed to their Default values. All Setpoints will have to be programmed to their desired values. This message will clear when the WARNING RESET key is pressed on the home screen in OPERATOR (or higher) access mode.

“WARNING – CONDENSER – HIGH PRESSURE LIMIT”

The Condenser Pressure exceeds the High Pressure Warning Setpoint threshold, programmed by a Service technician logged in at SERVICE access level. While this condition is in effect, the Pre-rotation Vanes are inhibited from further opening. This message automatically clears and the Vanes are permitted to open when the Condenser pressure decreases to 0.1 PSIA below the Setpoint.

“WARNING – EVAPORATOR – LOW PRESSURE LIMIT”

The Evaporator pressure has decreased to the Warning threshold. This threshold is fixed in Water cooling applications. In Brine cooling applications, the threshold is a fixed amount above the programmable safety shutdown threshold. The Safety threshold in Brine applications is determined by the Brine solution and is determined by the YORK Factory. While this condition is in effect, the Pre-rotation Vanes are inhibited from further open-

ing. This message automatically clears and the Vanes are permitted to open when the Evaporator pressure increases to the reset value.

	Warning Threshold (PSIA)		Reset Threshold (PSIA)	
	Water	Brine	Water	Brine
R11	5.5	0.1 >Safety Setpoint	5.6	0.3>Safety Setpoint
R123	4.5	0.1 >Safety Setpoint	4.7	0.3>Safety Setpoint

“WARNING – VANES UNCALIBRATED – FIXED SPEED”

The Compressor Motor Variable Speed Drive (VSD) is operating Fixed Speed (full speed) mode because the Pre-rotation Vanes position potentiometer calibration has not been performed. Message automatically clears when calibration has been performed.

“WARNING – HARMONIC FILTER – OPERATION INHIBITED”

The compressor Motor variable Speed Drive (VSD) Harmonic Filter has been inhibited. Refer to VSD Service manual 160.00-M1. Harmonic filter operation should not be altered by anyone other than a qualified Service technician. Message automatically clears when filter is enabled.

“WARNING – HARMONIC FILTER – DATA LOSS”

Communications between the Harmonic Filter Logic Board and the Compressor Motor Variable Speed Drive (VSD) Logic Board or the Adaptive Capacity Control Board is not occurring. While this condition exists, all Filter related parameters are displayed as X's. This message automatically clears when communications are restored.

“WARNING – HARMONIC FILTER – INPUT FREQUENCY RANGE”

The power line frequency detected by the Compressor motor Variable Speed Drive (VSD) Harmonic Filter is outside the range of 58 to 62 Hz (60 Hz) or 49 to 51 Hz (50 Hz). While this condition exists, all Filter related parameters are displayed as X's. This message automatically clears when the line frequency is within range.

“WARNING – PURGE – HIGH PRESSURE”

With the chiller running, the purge pressure increased to >55.0 PSIA (standard purge units) or > 95.0 PSIA (high efficiency purge units) continuously for 4 minutes. This message will be displayed until the purge pressure decreases to the reset threshold of ≤ 55.0 PSIA (standard purge units), ≤ 95.0 PSIA (high efficiency purge units) or the chiller is not running and the WARNING RESET key is pressed on the HOME Screen in OPERATOR (or higher) access mode. This warning will not be displayed if the Purge Float Switch Error warning (below) is in effect.

“WARNING – PURGE – FLOAT SWITCH ERROR”

With the chiller running, the Purge Float Switches were in invalid states. Typically this is caused by the Bottom Float Switch being in the closed position and the Top Float Switch in the open position, indicating the oil level is simultaneously below the bottom switch and above the top switch, an impossible condition. This message will be displayed until the float switches are indicating valid positions (or the chiller is not running) and the WARNING RESET key is pressed on the HOME Screen in OPERATOR (or higher) access mode. While this message is displayed, the Purge Oil Solenoid Valve is de-energized, draining the Purge Tank.

“WARNING – EXCESS PURGE”

The purge EXHAUST COUNT has equaled the programmed MAXIMUM PURGES PER HOUR setpoint. While this message is displayed, purging continues but the EXHAUST COUNT is not incremented. Clearing this message resets the exhaust count and exhaust window. If the chiller is running, the exhaust window will then increment from 0 to 60 minutes and the exhaust count will increment as exhausts occur. This message will be displayed until the WARNING RESET key is pressed on the HOME Screen in OPERATOR (or higher) access mode.

“WARNING – PURGE – CANISTER #1 FULL” (Flash Memory Card version C.MLM.02.02.xxx and later)

The Purge Canister Alarm on the Lower Emissions Purge Canister #1 indicates the canister has captured its capacity of refrigerant. The canister must be replaced following instructions on label inside Purge Panel door. This message is triggered when the Purge Canister Alarm output increases to ≥ 2.20 VDC. This message will be displayed until the Alarm signal is ≤ 0.90 VDC and the WARNING RESET key is pressed on the HOME Screen in OPERATOR (or higher) access mode.

“WARNING – VANES UNCALIBRATED”

The Hot Gas Bypass feature is enabled, but the Pre-rotation Vanes calibration procedure has not yet been performed. Message automatically clears when calibration has been performed.

“WARNING – EXTERNAL I/O – SERIAL COMMUNICATIONS”

Serial communications between the Microboard and the optional Analog I/O Board has been interrupted for at least 20 seconds. Message automatically clears when communications are restored.

“WARNING – REFRIGERANT LEVEL OUT OF RANGE”**(Flash Memory Card version C.MLM.02.02C.xxx and earlier)**

The output of the Condenser Refrigerant Level Sensor is $> 5.1\text{VDC}$. This is indicative of a Level Sensor failure. While this condition exists, the Refrigerant Variable Orifice is driven to the full open position. This message automatically clears when the Refrigerant Level sensor output is within range.

“WARNING - EXCESS SURGE DETECTED”**(Flash Memory Card version C.MLM.02.02.xxx and later)**

(Applies only if Surge Protection SHUTDOWN feature is Disabled.) The Surge Window Count has exceeded the Count Limit. Message can be manually cleared after the Surge Window Count is \leq the Count Limit, the SHUTDOWN feature is Enabled or the chiller is stopped. To clear message press WARNING RESET key on HOME Screen when logged in at OPERATOR (or higher) access level.

“WARNING – SURGE PROTECTION – EXCESS SURGE LIMIT”**(Flash Memory Card version C.MLM.02.02.xxx and later)**

(Applies only if Surge Protection EXTENDED RUN feature is Enabled.) Displayed during the Surge Protection 10 minute Extended Run period. This period begins when the Surge Window Count exceeds the Count Limit. During this period, the Pre-rotation Vanes are driven closed. When 10 minutes have elapsed, this message and the Pre-rotation Vanes load inhibit are automatically cleared. Message and load inhibit are also cleared when the chiller is shutdown.

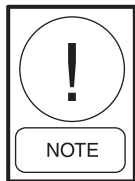

If the optional Hot Gas Bypass feature is enabled, the valve position must be at 100% before the Extended Run is implemented. If the chiller is chiller is equipped with a compressor motor Variable Speed Drive, the output frequency must be at full speed (50 Hz/60 Hz) before this control can be implemented.

ROUTINE SHUTDOWN MESSAGES**“REMOTE STOP”**

A shutdown command has been received from a remote device. Remote Stop commands can be received in Digital Remote mode via I/O Board TB4-7/8 or in

ISN (Integrated Systems Network) Remote mode via the MicroGateway serial communications.

“LOCAL STOP”

A local shutdown command has been received by placing the Keypad Start-Run-Stop/Reset Switch in the stop (O) position.

“PLACE COMPRESSOR SWITCH IN RUN POSITION”

The OptiView Control Center is in either Digital or ISN (Integrated Systems Network) Remote mode. The Operator is requested to place the COMPRESSOR Switch in the RUN position. The OptiView Control Center will not accept a Remote start/stop command unless the switch is in the RUN position.

CYCLING SHUTDOWN MESSAGES**“MULTIUNIT CYCLING – CONTACTS OPEN”**

The Multiunit Cycling contacts connected to I/O Board TB4-9, have opened to initiate a cycling shutdown. The chiller will automatically restart when the contacts close.

“SYSTEM CYCLING – CONTACTS OPEN”

The System Cycling contacts connected to I/O Board TB4-13, have opened to initiate a cycling shutdown. The chiller will automatically restart when the contacts close.

“OIL – LOW TEMPERATURE”

The oil temperature has decreased to $< 55^{\circ}\text{F}$. The chiller will automatically restart when the temperature increases to $> 71.0^{\circ}\text{F}$.

“CONTROL PANEL – POWER FAILURE”

A Control Power failure has occurred. If the power failure occurred while the chiller was running, it will automatically restart when power is restored. However, if the power failure duration was $<$ the duration of the applicable “Coastdown” period (2.5 minutes standard; 15 minutes steam turbine) when power is restored, the remainder of the “Coastdown” will be performed, prior to the chiller starting. This message can indicate a Cycling (auto-restart after power failure) or Safety (manual restart after power failure) shutdown, depending upon OptiView Control Center configuration. It indicates a cycling shutdown when displayed in orange characters; Safety shutdown when displayed in red characters. The OptiView Control Center is configured for auto-restart or manual restart after power failure by a qualified Service Technician following instructions in YORK Service Manual 160.55-M1.

“LEAVING CHILLED LIQUID – LOW TEMPERATURE”

The Leaving Chilled Liquid Temperature has decreased to the programmed Shutdown Temperature Setpoint. The chiller will automatically restart when the temperature increases to the programmed Restart Temperature Setpoint.

“LEAVING CHILLED LIQUID – FLOW SWITCH OPEN”

The Chilled Liquid Flow Switch has remained open for 2 continuous seconds while the chiller was running or failed to close during the System Pre-lube period. The chiller will automatically restart when the flow switch closes.

“CONDENSER – FLOW SWITCH OPEN”

The Condenser water flow switch has remained open for 2 continuous seconds while the chiller was running. This check is bypassed for the first 30 seconds of “System Run”. The chiller will automatically restart when the flow switch closes.

“MOTOR CONTROLLER – CONTACTS OPEN”

The CM-2 Current module (Electromechanical starter applications) or Solid State Starter Logic Board (Mod “A” Solid State Starter applications) has shutdown the chiller. When detecting a fault condition that places the starter or motor at risk, these devices open the Motor Controller contacts “CM” (located on the respective device and connected between TB6-16 and TB6-53 in the OptiView Control Center) to initiate a shutdown. Since there are several different faults that are monitored, LED’s on the respective device illuminate to identify the specific fault that has occurred. Refer to YORK Manual 160.46-OM3.1 for details of Mod “A” Solid State Starter initiated shutdowns and 160.55-M1 for CM-2 initiated shutdowns. The chiller will automatically restart when the Motor Controller contacts close. On some shutdowns, the respective device automatically closes the contacts when the fault condition clears. Other shutdowns require the Operator to perform a Manual Reset at the respective device.

Device	Manual Reset Fault	Automatic Reset Fault
CM-2 Module	Overload	None
Solid State Starter	Overload	Phase Rotation/Loss
	High Temp(>212°F)	High Temp start inhibit (>110°F)
	Fault Current	Trigger Board Out-of-Lock

“MOTOR CONTROLLER – LOSS OF CURRENT”

The Compressor Motor current decreased to 10% Full Load Amps (FLA) for 25 continuous seconds while the chiller was running. This could be caused by the starter de-energizing during run or a defect in the motor current feedback circuitry to the OptiView Control Center. The chiller will automatically restart at the completion of “System Coastdown”.

“POWER FAULT”

The CM-2 Current Module (Electro-mechanical starter applications) or Solid State Starter Logic Board (Mod “A”) (Solid State Starter applications) has shutdown the chiller because it detected a fault condition that places the motor at risk. These devices open and close the Motor controller “CM” contacts (located on the respective device and connected between TB6-16 and TB6-53 in the OptiView Control Center) in < 3 seconds to initiate the shutdown and produce this message. An LED on the respective device illuminates to identify the specific fault that has occurred. Refer to YORK Manual 160.46-OM3.1 for details of Mod “A” Solid State Starter initiated shutdowns and 160.55-M1 for CM-2 initiated shutdowns. The chiller will automatically restart when the contacts close.

Device	Shutdown
CM-2 Module	Power fault
Solid State Starter	Power Fault Half Phase

“CONTROL PANEL – SCHEDULE”

The programmed Daily Schedule Setpoint has shut down the chiller. The chiller will automatically restart at the next scheduled start time.

“STARTER – LOW SUPPLY LINE VOLTAGE” (Mod “A” Solid State Starter”)

The voltage in any phase of the AC Power Line Voltage supplying the Solid State Starter has decreased to the low line voltage threshold for 20 continuous seconds. The chiller will automatically restart when the voltage returns to the restart level. The thresholds are as follows:

Supply Voltage Range (Volts)	Shutdown (Volts)	Restart (Volts)
380	305	331
400	320	349
415	335	362
440-480	370	400
550-600	460	502
Supply Voltage Range disabled	none	N/A

“STARTER – HIGH SUPPLY LINE VOLTAGE” (Mod “A” Solid State Starter”)

The voltage in any phase of the AC Power Line Voltage supplying the Solid State Starter has increased to the high line voltage threshold for 20 continuous seconds. The chiller will automatically restart when the voltage returns to the restart level. The thresholds are as follows:

Supply Voltage Range (Volts)	Shutdown (Volts)	Restart (Volts)
380	415	414
400	436	435
415	454	453
440-480	524	523
550-600	655	654
Supply Voltage Range disabled	none	N/A

MOD “B” SOLID STATE STARTER CYCLING SHUTDOWN MESSAGES

“LCSSS – INITIALIZATION FAILED”

When AC Power is restored to the system after a power failure, an initialization process occurs wherein the OptiView Control Center attempts to establish communications through the serial communications link with the Liquid Cooled Solid State Starter. If communications are not established within 10 consecutive attempts, a Cycling shutdown is performed and this message is displayed. The Control Center attempts to establish communications until successful.

“LCSSS – SERIAL COMMUNICATIONS”

After communications have been successfully established in the INITIALIZATION process, the OptiView Control Center initiates a data transmission to the Liquid Cooled Solid State Starter on the serial communications link every 2 seconds. After these communications have been established, if the Control Center does not receive a reply within 10 consecutive attempts, a Cycling shutdown is performed and this message is displayed. This same Cycling shutdown is performed, along with the same message, if the Liquid Cooled Solid State Starter does not receive a response from the control center after 10 consecutive attempts to communicate with the Control Center after INITIALIZATION has been successfully completed. The Control Center attempts to establish communications until successful.

“LCSSS SHUTDOWN – REQUESTING FAULT DATA . . .”

The Liquid Cooled State Starter Logic/Trigger Board has shut down the chiller but the OptiView Control Center has not yet received the cause of the fault from

the LCSSS, via the serial communications link. The LCSSS shuts down the chiller by opening the Motor Controller LCSSS Stop Contacts (K1 relay located on the starter Logic/Trigger Board and connected between TB6-16 and TB6-53 in the OptiView Control Center). The Microboard, in the Control Center then sends a request for the cause of the fault to the Logic/Trigger Board over the serial communications link. Since serial communications are initiated every 2 seconds, this message is typically displayed for a few seconds and then replaced with one of the below listed fault messages.

“LCSSS – STOP CONTACTS OPEN”

Refer to “LCSSS SHUTDOWN – REQUESTING FAULT DATA ...” above. If the OptiView Control Center’s Microboard does not receive the cause of a starter initiated shutdown with 20 seconds of the shutdown, it is assumed it is not forthcoming and that message is replaced with this message. The chiller can be started when the Motor Controller LCSSS Stop Contacts close.

A missing interlock jumper between Starter Logic/Trigger Board J1-1 and J1-12 will also produce this message.

“LCSSS – POWER FAULT”

The Liquid Cooled Solid State Starter Logic/Trigger Board has detected that the compressor motor current in one or more phases has decreased to <10% of the FLA for a minimum of 1 line cycle. This check is inhibited during the first 4 seconds of SYSTEM RUN and until the motor current is >25% of the FLA. The chiller will automatically restart upon completion of SYSTEM COASTDOWN.

“LCSSS – LOW PHASE X TEMPERATURE SENSOR”

The Liquid Cooled Solid State Starter Logic/Trigger Board has detected that the temperature of the starter phase A, B or C (designated as X in the message) Silicon Controlled Rectifier (SCR) Module has decreased to <37°F. This would generally be indicative of a disconnected or defective sensor. If all three SCR Modules are indicating a temperature of <37°F, the SCR Module cooling pump turns on. This is accomplished by disconnecting all three sensors. This feature allows Service Technicians to run the cooling pump while filling the cooling system by disconnecting plugs P2, P3 and P4 in the LCSSS.

“LCSSS – RUN SIGNAL”

The Liquid Cooled Solid State Starter receives two start signals from the OptiView Control Center simul-

taneously; one via the serial communications link and one via the start relay TB6-24 in the OptiView Control Center. If they are not received within 5 seconds of one another, a cycling shutdown is performed and this message is displayed. This is generally indicative of defective wiring.

“LCSSS – INVALID CURRENT SCALE SELECTION”

There is an invalid compressor motor current scale jumper combination installed in the Liquid Cooled Solid Starter Logic/Trigger Board J1. Jumper combination determines allowable “100% FLA” setpoint range; 7L-35 to 260A, 14L-65 to 510A, 26L-125 to 850A and 33L-215 to 1050A. The chiller will be permitted to start when the jumpers are configured correctly. Refer to YORK Starter service manual 160.00-O2 for valid jumper configurations.

“LCSSS – PHASE LOCKED LOOP”

The Liquid Cooled Solid State Starter Logic/Trigger Board phase locked loop circuit was not able to maintain lock with phase A of the power line. This could be caused by a power line anomaly such as sag or jitter. A power line frequency jitter of up to 3 Hz/second can be tolerated. The chiller will automatically restart when lock has resumed.

“LCSSS – LOW SUPPLY LINE VOLTAGE”

The Liquid Cooled Solid State Starter Logic/Trigger Board has detected that the compressor motor AC power line voltage, in any phase, decreased below the low line voltage threshold continuously for 20 seconds. The chiller will automatically restart when the voltage in all phases returns to the restart level. The thresholds are as follows:

<u>Supply Voltage Range (Volts)</u>	<u>Shutdown(Volts)</u>	<u>Restart(Volts)</u>
Disabled	None	N/A
200-208	160	174
220-240	185	200
380	305	331
400	320	349
415	335	362
440-480	370	400
550-600	460	502

“LCSSS – HIGH SUPPLY LINE VOLTAGE”

The Liquid Cooled Solid State Starter Logic/Trigger Board has detected that the compressor motor AC power line voltage, in any phase, exceeded the high line voltage threshold continuously for 20 seconds. The chiller will automatically restart when the voltage in all phases returns to the restart level. The thresholds are as follows:

<u>Supply Voltage Range (Volts)</u>	<u>Shutdown(Volts)</u>	<u>Restart(Volts)</u>
Disabled	None	N/A
200-208	227	226
220-240	262	261
380	415	414
400	436	435
415	454	453
440-480	524	523
550-600	655	654

“LCSSS – LOGIC BOARD PROCESSOR”

Communication between the V25 Microprocessor and Digital Signal Processor (DSP) on the Liquid Cooled Solid State Starter Logic/Trigger Board has been interrupted. The chiller will automatically restart when communications are restored.

“LCSSS - PHASE LOSS”

(Flash Memory Card version C.MLM.02.01 or later)

The Liquid Cooled Solid State Starter Logic/Trigger Board has detected the line-to-line RMS voltage in any phase has decreased to $\leq 30\%$ of the lowest value of the programmed voltage range. If the programmed voltage range is “Disabled”, a value of 60VAC is used as the threshold. The chiller will automatically restart when the line voltage is $>$ the shutdown threshold. The voltage range is programmed by a Service technician following instructions in Service Manual 160.55-M1.

“LCSSS – PHASE ROTATION/LOSS”

(Flash Memory Card version C.MLM.02.00 only)

The Liquid cooled Solid State Starter Logic/Trigger Board has detected that the three-phase compressor motor power line voltage phase rotation is not correct or the line-to-line voltage in any phase has decreased to $<30\%$ of nominal. The chiller will automatically restart when the power line conditions are acceptable.

“LCSSS – LOGIC BOARD POWER SUPPLY”

Following application of power, this message is displayed and a snapshot of the LCSSS parameters and time of power failure are sent to the OptiView Control Center.

COMPRESSOR MOTOR VARIABLE SPEED DRIVE: CYCLING SHUTDOWN MESSAGES

The following Cycling shutdown messages are displayed on Compressor Motor Variable Speed Drive (VSD) applications only. These messages are generated by events that occur within the VSD. The chiller will automatically

restart when the cycling condition clears. Service and troubleshooting information is contained in YORK Manual 160.00-M1.

“VSD SHUTDOWN – REQUESTING FAULT DATA”

The VSD has shut down the chiller and the OptiView Control Center has not yet received the cause of the fault from the VSD, via the serial communications link. The VSD shuts down the chiller by opening the Motor Controller VSD Stop Contacts (located on the VSD Logic Board and connected between TB6-16 and TB6-53 in the OptiView Control Center). The Microboard in the OptiView Control Center then sends a request for the cause of the fault to the VSD Logic Board via the Adaptive Capacity Control Board, over the serial link. Since serial communications are initiated every 2 seconds, this message is typically displayed for a few seconds and then replaced with one of the below listed fault messages.

“VSD – STOP CONTACTS OPEN”

Refer to “VSD Shutdown – Requesting Fault Data” message above. If the OptiView Control Center’s Microboard does not receive the cause of the Fault over the Serial Link within 20 seconds, it is assumed it is not forthcoming and that message is replaced with **VSD – STOP CONTACTS OPEN** message.

“VSD INITIALIZATION FAILED”

Upon application of power, all boards go through the initialization process. At this time, memory locations are cleared, program jumper positions are checked and serial communications links are established. There are several causes for an unsuccessful initialization as follows:

- The OptiView Control Center and the VSD must be energized at the same time. The practice of pulling the fuse in the Control Center to remove power from the Control Center will create a problem. Power-up must be accomplished by closing the main disconnect on the VSD cabinet with all fuses in place. A power interruption to the VSD Logic board will also generate this message.
- The EPROMS must be of the correct version for each VSD board and they must be installed correctly. The EPROMS are created as a set and cannot be interchanged between earlier and later versions.
- Serial data communications must be established. Refer to VSD - Serial Communications fault. If communications between the VSD Logic Board, Harmonic Filter Logic Board, ACC Board and Control Center Microboard does not take place during

initialization, this message will be generated. The Serial communications can be verified by selecting the VSD DETAILS screen from the MOTOR screen and observing the Full Load amps value. A zero displayed for this and other VSD parameters, indicates a serial communications link problem.

- If the Harmonic Filter option is included, make sure the Filter Logic Board is not in continuous reset. This condition is evidenced by the Filter Logic Board’s LED’s alternately blinking. The filter can be eliminated as a cause of initialization failure by disconnecting the Filter by placing switch SW1 on the Filter Logic Board in the OFF position and removing the ribbon cable between the Filter Logic Board and the VSD Logic Boards.
- VSD and Harmonic Filter Horsepower ratings do not agree.

“VSD – HIGH PHASE A INSTANTANEOUS CURRENT”

This shutdown is generated by the VSD if the motor current in phase “A” exceeds a given limit. The motor current is sensed by the current transformers on the VSD output pole assemblies and the signals are sent to the VSD Logic Board for processing. Maximum instantaneous permissible currents are:

351/292 HP	=	771 Amps
503/419 HP	=	1200 Amps
790/658 HP	=	1890 Amps

If an overcurrent trip occurs, but the chiller restarts and runs without a problem, the cause may be attributed to a voltage sag on the utility power feeding the VSD that is in excess of the specified voltage range for this product. Thus is especially true if the chiller was running at or near full load. If there should be a sudden dip in line voltage, the current to the motor will increase, since the motor wants to draw constant horsepower. The chiller Prerotation Vanes cannot close quickly enough to correct for this sudden increase in current and the chiller will trip on an overcurrent fault.

If the chiller will not restart, but keeps tripping on this same shutdown, an output pole problem is the most likely cause. The VSD would require service under these conditions.

“VSD – HIGH PHASE B INSTANTANEOUS CURRENT”

See “**High Phase A Instantaneous Current**” message above.

“VSD – HIGH PHASE C INSTANTANEOUS CURRENT”

See **“High Phase A Instantaneous Current”** message above.

“VSD – PHASE A GATE DRIVER”

A second level of current protection exists on the VSD driver boards themselves. The collector-to-emitter saturation voltage of each IGBT is checked continuously while the device is gated on. If the voltage across the IGBT is greater than a set threshold, the IGBT is gated off and a shutdown pulse is sent to the VSD logic board shutting down the entire VSD system. A gate driver fault can be initiated when the VSD is not running.

“VSD – PHASE B GATE DRIVER”

See **“Phase A Gate Driver”** message above.

“VSD – PHASE C GATE DRIVER”

See **“Phase A Gate Driver”** message above.

“VSD – SINGLE PHASE INPUT POWER”

This shutdown is generated by the SCR trigger control and relayed to the VSD logic board to initiate a system shutdown. The SCR Trigger control uses circuitry to detect the loss of any one of the three input phases. The Trigger will detect the loss of a phase within one half line cycle of the phase loss. This message is also displayed every time power to the VSD is removed or if the input power dips to a very low level.

“VSD – HIGH DC BUS VOLTAGE”

The VSD’s DC link voltage is continuously monitored and if the level exceeds 745VDC, a Bus Over-Voltage shutdown is initiated. If this shutdown occurs, it will be necessary to look at the level of the 460VAC applied to the drive. The specified voltage range is 414 to 508VAC. If the incoming voltage is in excess of 508VAC, steps should be taken to reduce the voltage to within the specified limits.

“VSD – LOGIC BOARD POWER SUPPLY”

This shutdown is generated by the VSD logic board and it indicates that the low voltage power supplies for the logic boards have dropped below their allowable operating limits. The power supplies for the logic boards are derived from the secondary of the 120 to 24VAC transformer, which in turn, is derived from the 480 to 120VAC control power transformer. This message usually means the power to the VSD has been removed.

“VSD – LOW DC BUS VOLTAGE”

If the DC link drops below 500VDC (or 414VDC for 50

Hz applications), the drive will initiate a system shutdown. A common cause for this shutdown is a severe sag in the incoming power to the drive. Monitor the incoming three-phase AC line for severe sags and also monitor the DC link with a voltmeter.

“VSD – DC BUS VOLTAGE IMBALANCE”

The DC link is filtered by many large electrolytic capacitors, rated for 450VDC. These capacitors are wired in series to achieve 900VDC capability for the DC link. It is important that the voltage be shared equally from the junction of the center or series capacitor connection, to the negative bus and the positive bus. This center point should be approximately ½ of the total DC link voltage. Most actual bus voltage imbalance conditions are caused by a shorted capacitor or a leaky or shorted IGBT transistor in an output phase bank assembly. This usually indicates the VSD requires service.

“VSD – PRECHARGE – DC BUS VOLTAGE IMBALANCE”

This message indicates the same as the “VSD-DC Bus Voltage imbalance” message above, except the condition occurred during the Pre-lube period.

“VSD – HIGH INTERNAL AMBIENT TEMPERATURE”

The ambient temperature monitored is actually the temperature detected by a component mounted on the VSD logic board. The high ambient trip threshold is set for 140°F. Some potential causes for this shutdown are: internal VSD fan failure, VSD water pump failure or an entering condenser water temperature that exceeds the allowable limit for the job. Additional causes for the shutdown are:

- **Plugged Strainer** – The standard 1.5” Y-strainer contains a woven mesh element with 20 stainless steel wires per inch. This has been found to work adequately on most applications. Some users may have very dirty condenser water, which can cause the strainer to plug. Locations with special conditions may want to consider a dual strainer arrangement with quarter turn valves, to permit cleaning of one strainer with the unit still on line.
- **Plugged Heat-exchanger** – In cases where the strainer plugs frequently, the heat-exchanger may eventually plug or become restricted to the point of reduced flow. At this point, we suggest you back-flush the heat-exchanger by reversing the two rubber hoses which supply condenser water to-from the heat-exchanger. If the rust cannot be back-flushed, the heat-exchanger might have to be replaced.

- **Low Condenser Flow** – The VSD system requires 8 feet of pressure drop across the heat exchanger to maintain adequate GPM. If the pressure drop is less than 8 feet, it will be necessary to correct the flow problem or add a booster pump as is applied on retrofit chillers.

“VSD – INVALID CURRENT SCALE SELECTION”

Since the part number of the VSD Logic Board is the same on all horsepower sizes, the position of Program Jumpers tells the Logic Board the size of the VSD employed. This allows the VSD to properly scale the output current. If the Jumper configuration is invalid, a shutdown is performed and this message is generated. Refer to YORK VSD Service manual 160.00-M1.

“VSD – LOW PHASE A INVERTER HEATSINK TEMPERATURE”

(Style D VSD)

A Heatsink temperature sensor indicating a temperature <37°F will cause the chiller to shut down and display this message. In most cases, the problem will be an open thermistor or broken wiring to the thermistor. The normal thermistor resistance is 10K ohms at 77°F.

“VSD – LOW PHASE B INVERTER HEATSINK TEMPERATURE”

(Style D VSD)

See “Low Phase A Inverter Heatsink Temperature” message above.

“VSD – LOW PHASE C INVERTER HEATSINK TEMPERATURE”

(Style D VSD)

See “Low Phase A Inverter Heatsink Temperature” message above.

“VSD – LOW CONVERTER HEATSINK TEMPERATURE”

If VSD part number is 371-02767-XXX (60 Hz) or 371-03700-XXX (50 Hz), a heatsink temperature sensor indicating a temperature of <37°F will cause the chiller to shutdown and display this message. In most cases, the problem will be an open thermistor or broken wiring to the thermistor. The normal thermistor resistance is 10K ohms at 77°F.

“VSD – LOW PHASE A INVERTER BASEPLATE TEMPERATURE”

(VSD part number 371-03789-xxx (503HP 60Hz; 419HP 50Hz (Flash Memory Card version C.MLM.02.04.xxx and later)

The chiller has shutdown because the baseplate temperature has decreased to <37 °F.

“VSD – LOW PHASE B INVERTER BASEPLATE TEMPERATURE”

(VSD part number 371-03789-xxx (503HP 60Hz; 419HP 50Hz (Flash Memory Card version C.MLM.02.04.xxx and later)

The chiller has shutdown because the baseplate temperature has decreased to <37 °F.

“VSD – LOW PHASE C INVERTER BASEPLATE TEMPERATURE”

(VSD part number 371-03789-xxx (503HP 60Hz; 419HP 50Hz (Flash Memory Card version C.MLM.02.04.xxx and later)

The chiller has shutdown because the baseplate temperature has decreased to <37 °F.

“VSD – LOW INVERTER BASEPLATE TEMPERATURE”

(Applicable to VSD with part number 371-02767-XXX (60 Hz) or 371-03700-XXX (50 Hz))

(Requires Flash Memory Card version C.MLM.-02.02A.xxx and later)

A baseplate temperature sensor indicating a temperature of <37°F will cause the chiller to shut down and display this message. In most cases, the problem will be an open thermistor or broken wiring to the thermistor. The normal thermistor resistance is 5K ohms at 77°F.

“VSD – PRECHARGE – LOW DC BUS VOLTAGE”

During Pre-charge, the DC link must be equal to or greater than 50VDC (41VDC for 50 Hz) within ½ second and 500VDC within 15 seconds after the Pre-charge relay is energized. If this condition is not met, a shutdown is performed and this message is generated.

“VSD – LOGIC BOARD PROCESSOR”

This shutdown is generated if a communications problem occurs between the two microprocessors on the VSD Logic Board.

“VSD – RUN SIGNAL”

Redundant RUN signals are generated by the OptiView Control Center; one via TB6-24 and the second via the Serial Communications link. Upon receipt of either of the two RUN commands by the VSD, a 5 second timer shall commence timing. If both run commands are not received by the VSD Logic Board within 5 seconds, a shutdown is performed and this message is displayed.

This is generally indicative of a wiring problem between the OptiView Control Center and the VSD.

“VSD – SERIAL COMMUNICATIONS”

This message is generated when communications between the Adaptive Capacity Control (ACC) Board and the VSD Logic Board or between the OptiView Control Center Microboard and the VSD Logic Board, is disrupted. This is generally indicative of defective wiring between J11 on the VSD Logic Board and J8 on the ACC Board.

“HARMONIC FILTER – LOGIC BOARD OR COMMUNICATIONS”

This message is generated when communications between the Harmonic filter and the VSD Logic Board, is disrupted. If equipped with Flash Memory Card version C.MLM.02.03.xxx and later, the communications must be interrupted for 10 continuous communications cycles (20 seconds) before the shutdown will occur.

“HARMONIC FILTER – HIGH DC BUS VOLTAGE”

The Harmonic filter’s DC Link voltage is continuously monitored and if the level exceeds 860VDC, this shutdown is performed. The Harmonic Filter has its own DC bus as part of the Filter power assembly and this DC Link is not connected in any way with the VSD’s DC link. If this shutdown occurs, it will be necessary to look at the level of 460VAC applied to the Harmonic Filter. The specified voltage range is 414 to 508. If the incoming voltage is in excess of 508, steps should be taken to reduce the level to within specified limits. The cause of this message is typically high line voltage or a surge on the utility supply.

“HARMONIC FILTER – HIGH PHASE A CURRENT”

The maximum instantaneous harmonic filter current is monitored and compared to a preset limit. If this limit is exceeded, a shutdown is performed and this message is generated. The Filter current is monitored using two DCCT’s and these signals are processed by the filter logic board. The preset limits are as follows:

351/292 HP	=	356 Amps
503/419 HP	=	496 Amps
790/658 HP	=	745 Amps

If the VSD automatically restarts after this shutdown and continues to operate properly with the filter operating, it is likely the filter tripped due to a sag or surge in the voltage feeding the VSD. If this message reoccurs, pre-

venting the chiller from starting, the VSD will require service.

“HARMONIC FILTER – HIGH PHASE B CURRENT”

See “**Harmonic Filter – High Phase A Current**” message above.

“HARMONIC FILTER – HIGH PHASE C CURRENT”

See “**Harmonic Filter – High Phase A Current**” message.

“HARMONIC FILTER – PHASE LOCKED LOOP”

This shutdown indicates that a circuit called “Phase Locked Loop” on the filter logic board has lost synchronization with the incoming power line. This is usually indicative of an open fuse in one of the filter’s incoming power line. Filter power fuses 11FU, 12FU and 13FU should be checked.

“HARMONIC FILTER – PRECHARGE – LOW DC BUS VOLTAGE”

During pre-charge, the filter’s DC link must be equal to or greater than 50VDC (41VDC for 50 Hz) within 1/10 second after the pre-charge relay is energized. If this condition is not met, a shutdown is performed and this message is generated.

“HARMONIC FILTER – LOW DC BUS VOLTAGE”

The Harmonic Filter generates its own filter DC link voltage by switching its IGBT’s. This DC level is actually higher than the level that one could obtain by simply rectifying the input line voltage. Thus, the harmonic filter actually performs a voltage “boost” function. This is necessary in order to permit current to flow into the power line from the filter when the input line is at its peak level. This shutdown occurs when the filter’s DC link voltage decreases to a level less than 60VDC below the filter DC link voltage setpoint. This Setpoint is determined by the filter logic board via the sensing of the three phase input line-to-line voltage. This setpoint is set to the peak of the sensed input line-to-line voltage plus 32 volts, not to exceed 760 volts and it varies with the input line-to-line voltage. If this shutdown occurs occasionally, the likely cause is a severe sag in the input line voltage.

“HARMONIC FILTER – DC BUS VOLTAGE IMBALANCE”

The filter DC link is filtered by large, electrolytic capacitors, rated for 450VDC. These capacitors are wired

in series to achieve a 900VDC capability for the DC link. It is important the voltage is shared equally from the junction of the center or series capacitor connection, to the negative bus and to the positive bus. This center point should be approximately $\frac{1}{2}$ of the total DC link voltage.

“HARMONIC FILTER – INPUT CURRENT OVERLOAD”

The three phases of RMS filter current are monitored and if any one of the three phases continuously exceeds a given threshold for 7 seconds, a chiller shutdown is performed and this message is displayed. The maximum permissible continuous RMS current ratings for the harmonic filter are:

351/292 HP	=	128 AMPS
503/419 HP	=	176 AMPS
790/658 HP	=	277 AMPS

“HARMONIC FILTER – LOGIC BOARD POWER SUPPLY”

The low voltage power supplies on the filter logic board have decreased below their permissible operating range. The filter logic board receives its power from the VSD logic board via the ribbon cable, connecting the two boards.

“HARMONIC FILTER – RUN SIGNAL”

When a digital run command is received at the filter logic board from the VSD logic board via the 16 position ribbon cable, a 1/10 second timer is started. If a redundant run command does not occur on the serial data link from the VSD logic board before the timer expires, a shutdown is performed and this message is generated.

“HARMONIC FILTER – DC CURRENT TRANSFORMER 1”

During initialization, with no current flowing through the DC Current Transformers (DCCT's), the DCCT output voltages are measured and compared with a preset limit via the filter logic board. If the measured values exceed the preset limits, the DCCT's are presumed to be defective and this shutdown is generated.

“HARMONIC FILTER – DC CURRENT TRANSFORMER 2”

See “**Harmonic Filter – DC Current Transformer 1**” message above.

SAFETY SHUTDOWN MESSAGES

“EVAPORATOR – LOW PRESSURE”

(This message is applicable only if the Smart Freeze feature is not activated. If Smart Freeze is activated and has initiated the shutdown, “Evaporator – Low Pressure – Smart Freeze” is displayed as described next.)

The evaporator pressure, as sensed by the Evaporator Transducer, has decreased to the Safety shutdown threshold. For water cooling applications, the safety shutdown threshold is a fixed value for the respective refrigerant. For Brine cooling applications, the safety shutdown threshold varies according to the concentration of the Brine solution. The Brine shutdown threshold is programmed at the YORK Factory. It should not be changed by anyone other than a qualified Service Technician following instructions in YORK Service Manual 160.55-M1. The chiller can be started after the evaporator pressure increases to the restart threshold and the COMPRESSOR switch is placed in the Stop-Reset (O) position.

		Shutdown (PSIA)	Restart (PSIA)
Water cooling -	R11	<5.4	≥5.4
	R123	<4.4	≥4.4
Brine cooling -	R11/R123	0.0 to 12.5 as programmed	≥ Shutdown threshold

“EVAPORATOR – LOW PRESSURE – SMART FREEZE”

Smart Freeze Protection is activated and has shut down the chiller because the evaporator temperature has been below the Smart Freeze threshold for greater than the allowable number of seconds. If the evaporator refrigerant temperature sensor RT7 is Enabled (using procedure in Service Manual 160.55-M1), this parameter is used as the evaporator refrigerant temperature and the freeze threshold is 32.8°F. If RT7 is not Enabled, the evaporator refrigerant temperature used is the Evaporator Saturation Temperature, derived from the Evaporator Pressure Transducer and the freeze threshold is 34.0°F.

The count is incremented once for every second the evaporator refrigerant temperature is below the freeze threshold (but is never decremented below zero). The number of seconds it will take the chilled liquid to freeze is based on how far the evaporator refrigerant temperature is below the freeze threshold as follows:

Number of seconds to freezing = $(4053.7) / (\text{freeze threshold} - \text{evaporator refrigerant temperature})$

Smart Freeze is activated only if the feature has been

Enabled by a Service Technician (following instructions in Service Manual 160.55-M1) **and** the Leaving Chilled Liquid temperature Setpoint is $<38.0^{\circ}\text{F}$.

“EVAPORATOR – TRANSDUCER OR LEAVING LIQUID PROBE”

A possible defective Evaporator pressure Transducer or Leaving Chilled Liquid temperature Thermistor has been detected. The pressure and temperature that these devices are indicating are not in the correct relationship to each other. The OptiView Control Center converts the evaporator pressure to a Saturated Temperature value and compares this value to the Leaving Chilled Liquid temperature (difference = chilled liquid temp – evaporator saturated temp). The difference should not be outside the range of -2.5°F to $+25.0^{\circ}\text{F}$. If the Transducer and Thermistor are accurate, the Evaporator Saturated temperature should not be $> 2.5^{\circ}\text{F}$ warmer nor $> 25.0^{\circ}\text{F}$ colder than the leaving chilled liquid temperature. In order to initiate a shutdown, the difference must be outside the acceptable range continuously for 10 minutes. For Steam Turbine drive applications, this check is bypassed for the first 20 minutes of chiller operation. The chiller can be started after the **COMPRESSOR** switch is placed in the Stop-Reset (O) position.

“EVAPORATOR – TRANSDUCER OR TEMPERATURE SENSOR”

A possible defective Evaporator pressure Transducer or Refrigerant Temperature Sensor has been detected. The OptiView Control Center converts the evaporator pressure to a Saturated Temperature value and compares this value to the optional Evaporator Refrigerant Temperature Sensor. If the difference between these temperatures is greater than 3.0°F , continuously for 1 minute, this shutdown is performed. This check is only performed under the following conditions:

- Chiller has been running for at least 10 minutes
- Evaporator Refrigerant temperature (RT7) has been enabled by a Service technician using instructions in YORK Service Manual 160.55.M1
- Not in Brine cooling mode
- Smart Freeze is enabled (Flash Memory Card version C.MLM.02.02.xxx and later)
- Evaporator Temperature Sensor (RT7) or Evaporator Saturation Temperature is indicating a temperature of $<32.0^{\circ}\text{F}$ (Flash Memory Card version C.MLM.02.02.xxx and later)

The chiller can be started after the temperatures are within 3.0°F of one another and the **COMPRESSOR** switch is placed in the Stop-reset (O) position.

“CONDENSER – HIGH PRESSURE CONTACTS OPEN”

The contacts of the electro-mechanical high pressure safety device, located on the condenser shell, have opened because this device has detected a pressure > 29.7 PSIA. The contacts will automatically close when the condenser pressure decreases to < 23.7 PSIA. The chiller can be started after the contacts close and the **COMPRESSOR** switch is placed in the Stop-Reset (O) position.

“CONDENSER – HIGH PRESSURE”

The condenser pressure, as sensed by the Condenser Transducer, has increased to >29.7 PSIA. The chiller can be started after the pressure decreases to <23.7 PSIA and the **COMPRESSOR** switch is placed in the Stop-Reset (O) position.

“CONDENSER – HIGH PRESSURE – STOPPED”

(Software versions C.MLM.02.06.xxx and later or C.OPT.02.06.303 and later)

The condenser pressure exceeded 26.7 PSIA while the chiller was stopped. High temperature condenser water flowing through the condenser while the chiller is shutdown can cause a condenser high pressure condition resulting in loss of refrigerant. This safety fault anticipates this problem by annunciating the condenser high pressure condition. The chiller can be restarted after a Service Technician performs a special reset preset procedure contained in YORK Service Manual 160.55-M1.

“CONDENSER – PRESSURE TRANSDUCER OUT OF RANGE”

The Condenser Pressure Transducer is indicating a pressure that is >35.3 PSIA. This is outside the normal operating range of the transducer. This is generally indicates a defective transducer. The chiller can be started after the transducer is indicating a pressure that is ≤ 35.3 PSIA and the **COMPRESSOR** switch is placed in the Stop-Reset (O) position.

“AUXILIARY SAFETY – CONTACTS CLOSED”

The Auxiliary Safety shutdown contacts, connected to I/O Board TB4-31 have closed, initiating a safety shutdown. This input is a general-purpose, user defined safety shutdown input. The chiller can be started after the contacts open and the **COMPRESSOR** switch is placed in the Stop-Reset (O) position.

“DISCHARGE – HIGH TEMPERATURE”

The discharge temperature, as sensed by the Discharge Temperature Thermistor, has increased to > 220.0°F. The chiller can be started after the temperature decreases to < 220.0°F and the COMPRESSOR switch is placed in the Stop-Reset (O) position.

“DISCHARGE – LOW TEMPERATURE”

The discharge temperature, as sensed by the Discharge Temperature Thermistor, has decreased to < 30.0°F. The chiller can be started after the temperature increases to > 30.0°F and the COMPRESSOR switch is placed in the Stop-Reset (O) position.

“OIL – HIGH TEMPERATURE”

The oil temperature, as sensed by the Oil Temperature Thermistor, has increased to > 180.0°F. The chiller can be started after the temperature decreases to ≤ 180.0°F and the Compressor switch is placed in the Stop-Reset (O) position.

“OIL – LOW DIFFERENTIAL PRESSURE”

The differential oil pressure decreased to < 15.0 PSID while the chiller was running or failed to achieve 20.0 PSID during the last 5 seconds of the “System Prelube” period. The differential oil pressure is the difference between the output of the Sump Oil Pressure Transducer (system low pressure) and the output of the Pump Oil Pressure Transducer (system high pressure). The chiller can be started after the COMPRESSOR switch is placed in the Stop-Reset (O) position.

“OIL - HIGH DIFFERENTIAL PRESSURE”

The differential oil Pressure increased to > 60.0 PSID while the oil pump was running. The differential oil pressure is the difference between the output of the Sump Oil Pressure Transducer (system low pressure) and the output of the Pump Oil Pressure Transducer (system high pressure). The chiller can be started after the differential oil pressure decreases to < 60.0 PSID and the COMPRESSOR switch is placed in the Stop-reset (O) position.

“CONTROL PANEL – POWER FAILURE”

A Control Power failure has occurred. If the power failure duration was < the duration of the applicable “Coastdown” period (2.5 minutes standard; 15 minutes steam turbine), the remainder of the “Coastdown” is performed upon restoration of power. The chiller can be started after the COMPRESSOR switch is placed in the Stop-reset (O) position. This message can indicate a Cycling (auto-restart after power failure) or Safety (manual restart after power failure) shutdown, depending

upon Control Center configuration. It indicates a Cycling shutdown when displayed in orange characters; Safety shutdown when displayed in red characters. The OptiView Control center is configured for auto-restart or manual restart after power failure by a qualified Service technician following instructions in YORK Service Manual 160.55-M1.

“MOTOR OR STARTER – CURRENT IMBALANCE”

The three phase compressor motor current imbalance was > 30% continuously for 45 seconds. The imbalance is not checked until the chiller has been running for at least 45 seconds and the average of the three phases of motor current is > 80% of the programmed 100% chiller Full Load Amps. The average is calculated as: $I_{ave} = (I_a + I_b + I_c) \div 3$. The imbalance is calculated as:

$$\frac{(I_a - I_{ave}) + (I_b - I_{ave}) + (I_c - I_{ave})}{2(I_{ave})} \times 100$$

The Style B Solid State Starter detects the unbalance condition and advise the Optiview Control Center Microboard via serial communications. The Style A Solid State Starter and Variable Speed Drives returns the 3-phase motor current values to the Optiview Control Center Microboard where the unbalance calculation is performed. This safety shutdown is not performed on Electro-mechanical starter applications

“WATCHDOG – SOFTWARE REBOOT”

The Microboard’s software Watchdog initiated a Microprocessor reset because it detected that a portion of the chiller operating Program was not being executed. The result of this reset is a Safety shutdown and re-initialization of the Program. This is generally indicative of a severe electrical power disturbance or impending Microboard Failure. The chiller can be started after the COMPRESSOR switch is placed in the Stop-Reset (O) position.

“SURGE PROTECTION – EXCESS SURGE”

(Flash Memory Card version C.MLM.02.02.xxx and later)

(Applies only if Surge Protection SHUTDOWN feature is Enabled) The Surge Window Count surge events exceeded the Count Limit setpoint. If the Surge Protection Extended Run feature is Disabled, the chiller shutdown as soon as the count exceeds the limit. If the Extended Run feature is Enabled, this shutdown occurs only if the count exceeds the limit at completion of the 10 minute Extended Run period. The chiller can be started after the COMPRESSOR Switch is placed in the Stop-Reset (O) position.

MOD “B” SOLID STATE STARTER SAFETY SHUTDOWN MESSAGES

“LCSSS SHUTDOWN – REQUESTING FAULT DATA...”

The Liquid Cooled Solid State Starter Logic/Trigger Board has shut down the chiller but the Control Center has not yet received the cause of the fault from the LCSSS, via the serial communications link. The LCSSS shuts down the chiller by opening the Motor Controller **LCSSS Stop Contacts** (K1 relay located on the Logic/Trigger Board and connected between TB6-16 and TB6-53 in the Control Center). The Microboard, in the Control Center, then sends a request for the cause of the fault to the Logic/Trigger Board over the serial communications link. Since serial communications are initiated every 2 seconds, this message is typically displayed for a few seconds and then replaced with the one of the below listed fault messages.

“LCSSS – HIGH INSTANTANEOUS CURRENT”

The Liquid Cooled Solid State Starter Logic/Trigger Board detected that the compressor motor current in any phase exceeded 1.1(1.414xRMS value of the programmed Start Current) for a minimum of 1 second. The chiller can be started after the COMPRESSOR switch is placed in the Stop-Reset (O) position.

“LCSSS – HIGH TEMPERATURE PHASE X – RUNNING”

The Liquid Cooled Solid State Starter Logic/Trigger Board has detected the temperature of phase A, B or C (designated as X in the message) Silicon Controlled Rectifier (SCR) Modules has exceeded 212°F while the chiller was running. The safety can be reset after all SCR temperatures are < 210°F and the COMPRESSOR switch is placed in the Stop-Reset position (O). However, the chiller cannot be started until all SCR temperatures are < 109°F. During the shutdown, the starter cooling pump runs until the temperature is < 109°F.

“LCSSS – 105% MOTOR CURRENT OVERLOAD”

The highest phase of the compressor motor current increased to > 105% of the programmed 100% chiller Full Load Amps continuously for 40 seconds. The chiller can be started after the COMPRESSOR switch is placed in the Stop-Reset (O) position.

“LCSSS – PHASE X SHORTED SCR”

A shorted Silicon Controlled Rectifier (SCR) in phase A, B or C (designated as X in the message) has been detected by the Liquid Cooled Solid State Starter

Logic/Trigger Board. The voltage across each SCR in monitored to detect the shorted condition. The shorted condition must exist continuously for 5 seconds in order to annunciate the fault. This check is disabled while the chiller is running. The chiller can be started after the condition has been corrected and the COMPRESSOR switch is placed in the Stop-Reset (O) position.

“LCSSS – OPEN SCR”

An open Silicon Controlled Rectifier (SCR) has been detected by the Liquid Cooled Solid State Starter Logic/Trigger Board. The open condition must exist continuously for 5 seconds in order to annunciate the fault. The chiller can be started after the condition has been corrected and the COMPRESSOR switch is placed in the Stop-Reset (O) position. This check is disabled when the chiller is shut down. In certain applications, local power line conditions could interfere with the open SCR detection technique. This requires a qualified Service Technician to disable this check. Refer to YORK Service Manual 160.55-M1.

“LCSSS – PHASE (X) OPEN SCR”

(Software versions C.MLM.02.06.xxx and later or C.OPT.02.06.303 and later)

An open SCR in phase A, B or C (designated as X in message) has been detected. This safety shutdown has the same criteria as “LCSSS – OPEN SCR” above. However, when the Solid State Starter Logic/Trigger Board is equipped with Eprom version C.SSS.01.03 (and later) and the Optiview Control Center is equipped with above software, the phase in which the open SCR occurred is identified

“LCSSS – PHASE ROTATION”

(Flash memory Card version C.MLM.02.01 or later)

The Liquid Cooled Solid State Starter Logic/Trigger Board has detected the three phase compressor motor power line voltage phase rotation is not correct. The chiller can be started after the phase rotation is correct and the COMPRESSOR Switch is placed in the Stop-Reset (O) position.

COMPRESSOR MOTOR VARIABLE SPEED DRIVE: SAFETY SHUTDOWN MESSAGES

The following Safety shutdown messages are displayed on Compressor Motor variable Speed Drive (VSD) applications only. These messages are generated by events that occur within the VSD. The chiller can be started after manual resets are performed as detailed below. Service and troubleshooting information is contained in YORK Manual 160.00-M1.

“VSD SHUTDOWN – REQUESTING FAULT DATA”

The VSD has shut down the chiller and the control center has not yet received the cause of the fault from the VSD, via the serial communications link. The VSD shuts down the chiller by opening the Motor Controller “VSD Stop Contacts” (located on the VSD Logic Board and connected between TB6-16 and TB6-53 in the Control Center). The Microboard in the Control Center then sends a request for the cause of the fault to the VSD Logic Board via the Adaptive Capacity Control Board, over the serial link. Since serial communications are initiated every 2 seconds, this message is typically displayed for a few seconds and then replaced with one of the following fault messages.

“VSD – 105% MOTOR CURRENT OVERLOAD”

This shutdown is generated by the VSD Logic Board and it indicates that a motor overload has occurred. The shutdown is generated when the VSD Logic Board has detected that at least 1 of the 3 output phase currents has exceeded 105% of the chiller Full Load Amps (FLA) value for > 7 seconds. The chiller FLA value is set by adjustment of the FLA potentiometer on the VSD Logic Board. The chiller can be started after the RESET push-button on the VSD Logic Board is pressed and the COMPRESSOR switch is placed in the Stop-reset position (O).

“VSD – HIGH PHASE A INVERTER HEATSINK TEMPERATURE”

(Style D VSD)

This shutdown will occur if the heatsink temperature exceeds 158°F on any of the output pole assemblies. This shutdown will seldom occur. In most cases where the coolant temperature has risen abnormally, the VSD will shut down on “Ambient Temperature” @ 140.0 °F before the heatsinks can reach 158°F. If this message is displayed, make sure there is adequate coolant level, ascertain the pump is operating when the chiller is running and check the strainer in the primary of the heat exchanger for clogs and silt. The chiller can be started after the fault condition clears, the RESET button on the VSD Logic Board is pressed and the COMPRESSOR switch is placed in the Stop-reset position (O).

“VSD – HIGH PHASE B INVERTER HEATSINK TEMPERATURE”

(Style D VSD)

See Phase A message above.

“VSD – HIGH PHASE C INVERTER HEATSINK TEMPERATURE”

(Style D VSD)

See Phase A message above.

“VSD – HIGH CONVERTER HEATSINK TEMPERATURE”

(Style D VSD)

See Phase A message above.

“VSD – HIGH CONVERTER HEATSINK TEMPERATURE”

(Applicable to VSD with part number 371-02767-XXX (60 Hz) and 371-03700-XXX (50 Hz))

(Requires Flash Memory Card version C.MLM.-02.02A.xxx and later)

This shutdown will occur if the heatsink temperature exceeds 170°F. The chiller can be started after the fault condition clears and the COMPRESSOR Switch is placed in the Stop-reset (O) position.

“VSD - HIGH INVERTER BASEPLATE TEMPERATURE”

(Applicable to VSD with part number 371-02767-XXX (60 Hz) and 371-03700-XXX (50 Hz))

(Requires Flash Memory Card version C.MLM.-02.02A.xxx and later)

This shutdown will occur if the baseplate temperature exceeds 175°F. The chiller can be started after the fault condition clears, the RESET button on the VSD Logic Board is pressed and the COMPRESSOR Switch is placed in the Stop-reset position (O).

“VSD – HIGH PHASE A INVERTER BASE-PLATE TEMPERATURE”

(VSD part number 371-03789-xxx (503HP 60Hz; 419HP 50Hz (Flash Memory Card version C.MLM.02.04.xxx and later)

The chiller has shutdown because the baseplate temperature has increased to >158 °F. The chiller can be started after the fault condition clears, the RESET button on the VSD Logic Board is pressed and the COMPRESSOR switch is placed in the Stop-reset (O) position.

“VSD – HIGH PHASE B INVERTER BASE-PLATE TEMPERATURE”

(VSD part number 371-03789-xxx (503HP 60Hz; 419HP 50Hz (Flash Memory Card version C.MLM.02.04.xxx and later)

The chiller has shutdown because the baseplate temperature has increased to >158 °F. The chiller can be started after the fault condition clears, the RESET button on the

VSD Logic Board is pressed and the COMPRESSOR switch is placed in the Stop-reset (O) position.

"VSD – HIGH PHASE C INVERTER BASE-PLATE TEMPERATURE"

(VSD part number 371-03789-xxx (503HP 60Hz; 419HP 50Hz (Flash Memory Card version C.MLM.02.04.xxx and later)

The chiller has shutdown because the baseplate temperature has increased to >158 °F. The chiller can be started after the fault condition clears, the RESET button on the VSD Logic Board is pressed and the COMPRESSOR switch is placed in the Stop-reset (O) position.

"VSD – PRECHARGE LOCKOUT"

If the VSD fails to make Pre-charge, the Pre-charge relay shall drop out for 10 seconds during which time the VSD's fans and water pumps shall remain energized in order to permit the Pre-charge resistors to cool. Following this 10-second cool down period, Pre-charge shall again be initiated. The VSD shall attempt to make Pre-charge 3 consecutive times. If the VSD fails to make Pre-charge on 3 consecutive tries, the unit will shut down, lockout and display this message. The chiller can be started after the **COMPRESSOR** switch is placed in the Stop-reset (O) position.

"HARMONIC FILTER – HIGH HEATSINK TEMPERATURE"

(Style D VSD)

The Harmonic Filter power assembly has one heatsink thermistor on the 351 and 503 HP units and two heatsink thermistors on the 790 HP units. If the temperature on any heatsink exceeds 167°F, the unit will shut down. This message is usually an indication of a low coolant level in the VSD cooling loop. The chiller can be started after the fault condition clears, the OVERTEMP RESET button on the Filter Logic Board is pressed and the COMPRESSOR switch is placed in the Stop-reset (O) position.

"HARMONIC FILTER – HIGH BASEPLATE TEMPERATURE"

(Applicable to VSD with part number 371-02767-XXX (60 Hz) and 371-03700-XXX (50 Hz))

(Requires Flash Memory Card version C.MLM.-02.02A.xxx and later)

This shutdown occurs when the Baseplate temperature exceeds 174°F (79°C). The chiller can be started after the fault condition clears, the OVERTEMP RESET button on the Filter Logic Board is pressed and the COMPRESSOR Switch is placed in the Stop-reset position (O).

"HARMONIC FILTER – HIGH BASEPLATE TEMPERATURE"

(VSD part number 371-03789-xxx (503HP 60Hz; 419HP 50Hz (Flash Memory Card version C.MLM.02.04.xxx and later)

The chiller has shutdown because the Baseplate temperature has increased to >194 °F. The chiller can be started after the fault condition clears, the OVERTEMP reset button on the Filter Logic Board is pressed and the COMPRESSOR switch is placed in the stop-reset (O) position

"HARMONIC FILTER – HIGH TOTAL DEMAND DISTORTION"

This shutdown indicates the filter is not operating correctly and the input current to the VSD/Filter is not sinusoidal. This shutdown will occur if the TDD exceeds 25% continuously for 45 seconds. TDD is an acronym for Total Demand Distortion, a term defined by the IEEE Std 519-1992 standard as the "total root-sum-square harmonic current distortion, in percent of the maximum demand load current (15 or 30 min demand)". In the Filter option supplied by YORK, the displayed TDD is the total RMS value of all the harmonic current supplied by the main power to the VSD divided by the chiller Full Load Amps, in percent. A standard VSD, less the optional filter typically has an input current TDD level on the order of 28-30%. The chiller can be started after the COMPRESSOR switch is placed in the Stop-reset position (O).

**THIS PAGE INTENTIONALLY LEFT BLANK
TO MAINTAIN FORMAT**

SECTION 3 PRINTERS

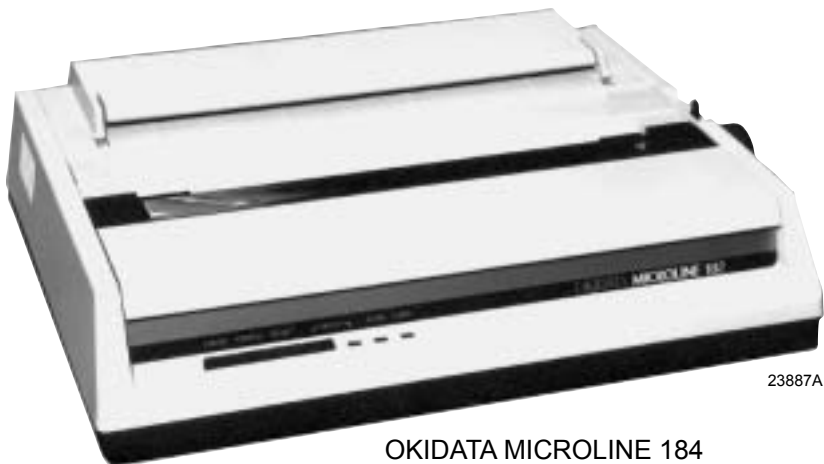

23887A

OKIDATA MICROLINE 184



23889A

WEIGH-TRONIX



00085VIP

SEIKO DPU-414

FIG. 43 – PRINTERS

A printer can be connected to the Control Center's Microboard to print the following reports. The screen from which each report can be generated is listed in parenthesis.

- **Status** - Present system parameters (Printer, Home)
- **Setpoints** - Present programmed values of all setpoints (Printer, Setpoints)
- **Schedule** - Present value of programmed daily schedule (Printer, Schedule)
- **Sales Order** - Information on Sales Order Screen (Printer, Sales Order)
- **History** - System parameters at the time of the last normal stop, last fault while running and last 10 faults, whether running or not (Printer, History)
- **Cycling or Safety shutdown initiated Print** - Snapshot of all system parameters at instant of shutdown. Automatically occurs if printer is connected at time of shutdown.
- **Adaptive Capacity Control (ACC) surge Map** - System conditions at instant all surge points were mapped. (Compressor Motor Variable Speed Drive applications; requires **SERVICE** access level) (Printer, ACC)
- **Trend (Flash Memory card version C.MLM.02.02.xxx and later)** - Prints a snapshot of the existing trend screen data or prints new data collected after the trend print key is pressed.

The printer can be permanently connected to the Control Center or connected as required to produce a report. If permanently connected, a **DATA LOGGING** feature can produce a Status report automatically, beginning at an Operator selected start time and occurring at an Operator selected interval thereafter.

The following figures are examples of the different print reports. Solid State Starter application print reports shown. Electro-mechanical starter and Variable Speed Drive reports are similar but print parameters applicable to those devices.

- Figure 44 - Status
- Figure 45 - Setpoints
- Figure 46 - Schedule
- Figure 47 - Sales Order
- Figure 48 - History
- Figure 49 - Security Log (Flash Memory Card version C.MLM.02.03.xxx and later)
- Figure 50 - Trend (Flash Memory Card version C.MLM.02.02.xxx and later)
- Figure 51 - Custom Screen

- Figure 52 - Adaptive Capacity Control New Map point Report
- Figure 53 - Adaptive Capacity Control Existing Map points Report

PRINTERS

The following Printers can be used. **Printers must be equipped with an RS-232 Serial interface.**

- **Okidata** –
Models: 182,182 turbo, 184 turbo
Dimensions: 14 in. wide x 10.5 in. deep
Paper: 8.5 in. wide
Type: Dot matrix impact
Purchase: 800-OKIDATA
- **Weigh-Tronix** –
Models: 2600, 1220
Dimensions: 2.3 in. wide x 2.8 in. deep
Paper: 2.25 in. wide
Type: Dot matrix impact
Purchase: USA 800-982-6622
International 707-527-5555
- **Seiko** –
Model: DPU414-30B (Power supply PW4007-U I required)
Dimensions: 6.3 in. wide x 6.7 in. deep
Paper: 4.4 in. wide
Type: Thermal
Purchase: Repton Electronics, Inc
Phone: 800-800-5441 ext. 4686
Fax: 813-891-4056
Attn: Nancy Arthur, Account Mgr.
(narthur@repton.com)

The Control Center provides the required formatting control codes for the printers above when the printer is selected on the PRINTER Screen in the instructions below. These codes are transmitted through the serial interface to the printer to provide a proper print format. Different printers require different formatting control codes. Other printers might provide proper operation when connected to the Control Center. However, the print format may not be correct or as desired. Proceed with caution and use the following guidelines if an unlisted printer is selected:

1. All must be capable of RS-232 Serial communications.
2. Primary differences between printers involve the formatting control codes required by the printer. These

codes are sent from the Control Center to the printer. For example, Weigh-Tronix printers require a control code to select 40 column width. This same code is interpreted by the Okidata printer as an instruction to print wide characters. In some instances, a printer will ignore a code it cannot interpret.

- The Control Center requires a busy signal from the printer when the printer receive buffer is full. This causes the Control Center to momentarily terminate data transmission until the printer can accept more data. The busy signal polarity must be asserted low when busy.

PRINTER CONNECTIONS

Connect the printers to the Control Center Microboard as follows. Only one printer can be connected at a time.

• **OKIDATA 182, 182 turbo, 184 turbo**

Microboard	Printer	Function
J2-4	pin 3	Tx (data to printer)
J2-2	pin 11	DSR (busy signal from printer)
J2-9	pin 7	Gnd
Cabinet		shield

• **WEIGH-TRONIX**

Microboard	Printer	Function
J2-4	pin 2	Tx (data to printer)
J2-2	pin 5	DSR (busy signal from printer)
J2-9	pin 7	Gnd
Cabinet		shield

• **SEIKO**

Microboard	Printer	Function
J2-4	pin 3	Tx (data to printer)
J2-2	pin 8	DSR (busy signal from printer)
J2-9	pin 5	Gnd
Cabinet		shield

Hardware required:

Cable – #18 AWG stranded 50ft. maximum length.

Connectors –

- Microboard: None. Strip 1/4" insulation from wire and insert into screw terminal block.
- Printers: Okidata - 25 pin plug DB-25P or equivalent; Shell DB-C2-J9 or equivalent. Weigh-Tronix - Same as Okidata. Cable assembly available from Weigh-Tronix. Seiko - 9-Pin D-type Subminiature (DB-9 pin male).

PRINTER SETUP

The selected printer must be configured as follows. Refer to manual provided by Printer manufacturer with respective Printer.

• **OKIDATA 182, 182 turbo, 184 turbo Printer**

CONTROL BOARD Switch settings:

- SW1 - on Unslashed 0
- 2 - off Unslashed 0
- 3 - off Unslashed 0
- 4 - off Form Length 11 in.
- 5 - on Form Length 11 in.
- 6 - off Auto Line Feed off
- 7 - on 8 bit data
- 8 - off Enable front panel

If equipped with a SUPER SPEED serial Board:

- SW1-1 - on Odd or even parity
- 1-2 - on No parity
- 1-3 - on 8 bit data
- 1-4 - on Protocol ready/busy
- 1-5 - on Test select
- 1-6 - on Print mode
- 1-7 - off SDD(-) pin 11
- 1-8 - on SDD(-) pin 11
- 2-1 - on 1200 Baud*
- 2-2 - on 1200 Baud*
- 2-3 - off 1200 Baud*
- 2-4 - off DSR active
- 2-5 - on Buffer threshold 32 bytes
- 2-6 - on Busy signal 200ms
- 2-7 - on DTR space after power on
- 2-8 - not used

If equipped with HIGH SPEED serial board:

- SW1 - off (-) Low when busy
- 2 - off 1200 Baud*
- 3 - off 1200 Baud*
- 4 - on 1200 Baud*
- 5 - not used
- 6 - off no parity
- 7 - off Pin 20 & pin 11 act as busy line

• **WEIGH-TRONIX Printer**

- IMP-24 Model 2600

- SW1 - off 1200 Baud*
- 2 - on 1200 Baud*

Model 1220

- Configure Menu
 Baud= 1200
 Data Bits = 8
 Stop Bits = 1
 Hshake = Busy-Line
 Cols = 32
 Invert = No
 Font = 5 x 8
 Mag = None

- Custom Menu
 Auto Seq = No
 Zero = 0
 Pound sign = #
 _(Underscore)
 Busy invert = no
 Online/offline = yes
 Ext Ch Set = no
 Print ready = yes

Set Clock = not used
 Reset Seq = not used

• SEIKO

DipSW1-1 = off Input-Serial
 1-2 = on Printing speed high
 1-3 = on Auto loading - on
 1-4 = off Auto LF - off
 1-5 = on Setting Command - Enable
 1-6 = off Printing density - 100%
 1-7 = on Printing density - 100%
 1-8 = on Printing, density - 100%

DipSW 2-1= on Printing Columns - 40
 2-2 = on User Font Back-up - on
 2-3 = on Character Select - normal
 2-4 = off Zero - slash
 2-5 = on International character set -
 American
 2-6 = on International character set -
 American
 2-7 = on International character set -
 American
 2-8 = off International character set -
 American

DipSW 3-1= on Data length - 8 bits
 3-2 = on Parity Setting - no
 3-3 = on Parity condition - odd
 3-4 = on Busy control - H/W busy
 3-5 = on Baud rate select - 1200*

3-6 = off Baud rate select - 1200*
 3-7 = on Baud rate select - 1200*
 3-8 = off Baud rate select - 1200*

* Settings shown for 1200 Baud. Other Baud rates can be selected. Refer to Printer manufacturer's manual supplied with Printer.

CONTROL CENTER SETUP**Chiller ID**

Access Level Required: OPERATOR or Higher
 Using the COMMS Screen, assign an Identification number to the chiller. This number will appear at the top of each report.

Printer Setup

Access Level Required: OPERATOR or Higher
 Using the COMMS Screen, the Control Center must be configured to transmit data in the same format as the Printer is configured to receive the data. The following values must be entered.

- Baud Rate - Set as desired. Value selected must be the same as Printer configuration above.
- Data Bits - 8
- Parity - None
- Stop Bits - 1

Printer Type

Access Level required: OPERATOR or Higher
 Using the PRINTER Screen, the actual Printer type connected to the Control Center must be entered. Selection determines the control codes that are sent to the Printer. These codes determine such things as lines per inch, character width and general formatting. Available selections are: Okidata, Weigh-Tronix and Seiko.

Automatic Data Logging

Access Level required: OPERATOR or Higher.
 If automatic data logging is desired, a Status Report can be automatically printed at a specified interval beginning at a specified time, using the PRINTER Screen. The interval is programmable over the range of 1 minute to 1440 minutes in 1 minute increments. The first print will occur at the programmed START time and occur at the programmed OUTPUT INTERVAL thereafter. The time remaining until the next print is displayed on the PRINTER Screen.

- Automatic Printer Logging - Enables and disables automatic data logging
- Log Start Time - Enter the time the first print is desired.
- Output Interval - Enter the desired interval between prints.

```

YORK UPDATE
CHILLER ID 0
YORK Update Chiller ID
-----
(c) 1997 - 2001 YORK INTERNATIONAL
CORPORATION

SYSTEM RUN
LEAVING CHILLED LIQUID CONTROL
WARNING - PURGE - FLOAT SWITCH ERROR
[List all warnings presently active]

Controls C.MLM.02.03.102
Run Time 0 Days 2 Hr 59 Min

Operating Hours = 298 Hr
Number Of Starts = 106
Control Source = Local

Evaporator
-----
Leaving Chilled Active Setpoint = 45.0 ~F
Chilled Liquid Pump = Run
Chilled Liquid Flow Switch = Closed
Leaving Chilled Liquid Temperature = 50.0 ~F
Return Chilled Liquid Temperature = 59.3 ~F
Evaporator Pressure = 7.2 Psia
Evaporator Saturation Temperature = 41.1 ~F
Evaporator Refrigerant Temperature = 40.0 ~F
[If Refrigerant Sensor enabled]
Small Temperature Difference = 10.0 ~F

Condenser
-----
Condenser Liquid Pump = Run
Condenser Liquid Flow Switch = Closed
Leaving Condenser Liquid Temperature = 85.0 ~F
Return Condenser Liquid Temperature = 94.9 ~F
Condenser Pressure = 13.8 Psia
Condenser Saturation Temperature = 71.7 ~F
Small Temperature Difference = -13.3 ~F
Drop Leg Refrigerant Temperature = 85.0 ~F
[If Drop Leg Sensor enabled]
Sub Cooling Temperature = 2.0 ~F
[If Drop Leg Sensor enabled]

Compressor
-----
Discharge Temperature = 121.6 ~F
Vent Line Solenoid = On

Oil Sump
-----
Oil Pump Run Output = On
Oil Pressure = 30.7 Psid
Oil Sump Temperature = 137.9 ~F

[Skip the following section if Hot Gas Bypass is not
enabled]
Hot Gas
-----

```

```

Valve Position = 15 %
Pre-Rotation Vanes Position = 75 %
Surge
-----
Total Surge Count = 127
Surge Window Time = 1 Min
Surge Window Count = 0

[Skip the following section if Liquid Level is not
enabled]
Refrigerant Level Control
-----
Refrigerant Level Position = 35 %
Ramp Up Time Remaining = 15 Sec
[If Ramp Up in effect]

Purge Control
-----
Pressure = 42.8 Psia
Exhaust Count = 0
Exhaust Window = 60 Min

[Skip the following section if Motor Type is not EM]
Electro-Mechanical Starter
-----
Motor Run = On
% Full Load Amps = 94 %

[Skip the following section if Motor Type is not Mod A
SSS]
Liquid-Cooled Solid State Starter
-----
Motor Run = On
% Full Load Amps = 94 %
Phase A Voltage = 447 V
Phase B Voltage = 409 V
Phase C Voltage = 442 V
Phase A Current = 193 A
Phase B Current = 204 A
Phase C Current = 190 A

[Skip the following section if Motor Type is not Mod B
SSS]
Liquid-Cooled Solid State Starter
-----
Motor Run = On
% Full Load Amps = 94 %
Starter Model = 33L
KW Hours = 20723 KWH
Input Power = 145 KW
Phase A Voltage = 447 V
Phase B Voltage = 409 V
Phase C Voltage = 442 V
Phase A Current = 193 A
Phase B Current = 204 A

```

FIG. 44 – SAMPLE PRINTOUT (STATUS)

Phase C Current	= 190 A
Phase A Temperature	= 88 ~F
Phase B Temperature	= 89 ~F
Phase C Temperature	= 75 ~F

[Skip the following section if Motor Type is not VSD]
Variable Speed Drive

Motor Run	= On
% Full Load Amps	= 94 %
Pre-Rotation Vanes Position	= 75 %
Full Load Amps	= 402 A
Precharge Relay Output	= Off
Trigger SCR Output	= On
Water Pump Output	= On
KW Hours	= 14528 KWH
Input Power	= 150 KW
Output Frequency	= 60 Hz
Output Voltage	= 800 V
DC Bus Voltage	= 600 V
DC Inverter Link Current	= 300 A
Phase A Output Current	= 195 A
Phase B Output Current	= 198 A
Phase C Output Current	= 193 A
Internal Ambient Temperature	= 88 ~F
Converter Heatsink Temperature	= 102 ~F
Phase A Heatsink Temperature	= 93 ~F
Phase B Heatsink Temperature	= 99 ~F
Phase C Heatsink Temperature	= 97 ~F

[Skip the following section if Motor Type is not VSD,
or Filter
is not present]
Harmonic Filter Data

Precharge Contactor	= Off
Supply Contactor	= On
Operating Mode	= Running
Phase Rotation	= ABC
Total Supply KVA	= 148 KVA
Total Power Factor	= 0.97
DC Bus Voltage	= 608 V
Heatsink Temperature	= 102 ~F
Voltage Peak N-L1	= 200 V
Voltage Peak N-L2	= 200 V
Voltage Peak N-L3	= 200 V
L1-L2 RMS Voltage	= 215 V
L2-L3 RMS Voltage	= 215 V
L3-L1 RMS Voltage	= 215 V
L1 RMS Filter Current	= 150 A
L2 RMS Filter Current	= 150 A
L3 RMS Filter Current	= 150 A
L1 RMS Supply Current	= 152 A
L2 RMS Supply Current	= 152 A
L3 RMS Supply Current	= 152 A
L1 Voltage Total Harmonic Distortion	= 1.5 %

FIG. 44 – CONTINUED

YORK SETPOINTS
CHILLER ID 0

© 1997 - 1999 YORK INTERNATIONAL CORPO-
RATION

Mon 21 jun 1999 1:27 :39 PM

Software Versions

Controls = C.MLM.02.03.102
BIOS = C.MM.00.0
Kernel = 0.18
GUI = 0.25
SIO = 0.21
GPIC = 0.03
Ext I/O [Skip if Hot Gas Disabled] = 1996202110
VSD [Skip if Motor Type is not VSD] = C.VSD.01.1
SSS [Skip if Motor Type is not Serial SSS] =
C.SSS.01.01

System Information

System Language = English
Data Display Mode = English
Control Source = Local
Remote Analog Input Range = 0-10Volts
Clock = Enabled

Jumper Settings

Pre-Run = Standard
Coastdown = Standard
Chilled Liquid Pump Operation = Standard
Refrigerant Selection = R11
Anti-Recycle = Enabled
Power Failure Restart = Auto
Liquid Type = Water
Motor Type = LCSSS
Printer Setup

Automatic Printer Logging = Disabled
Log Start Time = 12:00 am
Output Interval = 60 Min
Printer Type = Okidata
Baud = 9600Baud
Data Bits = 8 Bits
Parity = None
Stop Bits = 1 Bit
COM 2 Setup

Baud = 19200Baud
Data Bits = 8 Bits
Parity = Odd
Stop Bits = 1 Bit

Evaporator

Leaving Chilled Local Setpoint = 45.0 ~F
Leaving Chilled ISN Setpoint = 45.0 ~F
Leaving Chilled Modem Setpoint = 45.0 ~F
Leaving Chilled Analog Setpoint = 45.0 ~F
Leaving Chilled Digital Setpoint = 45.0 ~F
Remote Range = 10.0 ~F
Sensitivity = Normal
Restart Offset = 0.0 ~F
Restart Setpoint = 45.0 ~F
Shutdown Offset = 4.0 ~F
Shutdown Setpoint = 41.0 ~F
Brine Low Evaporator Cutout = 5.0 Psia
Smart Freeze = Off
Refrigerant = Disabled

Condenser

High Pressure Warning Threshold = 28.8Psia
Drop Leg = Disabled

[Skip the following section if Hot Gas Bypass is not
enabled]

Hot Gas

Hot Gas = Disabled
Hold Period = 30 Min
Close Percentage = 5 %
Minimum Load = 1 ~F
Maximum Open = 80 %

Surge

Surge Sensitivity = 0.3
Shutdown = Enabled
Extended Run = Disabled
Count Limit = 15
Count Window = 5 Min

[Skip the following section if Liquid Level is not
enabled]

Refrigerant Level Control

Level Control = On
Setpoint = 50 %
Period = 3.5 Sec
Proportion Limit Open = 15 %
Proportion Limit Close = 45 %
Rate Limit Open = 10 %
Rate Limit Close = 10 %

Purge Control

Hi Efficiency = Off
Maximum Purges / Hour = 20

[Skip the following section if Motor Type is not EM]
Electro-Mechanical Starter

Local Motor Current Limit = 100 %
Remote ISN Current Limit = 100 %
Remote Analog Current Limit = 100 %
Remote Digital Current Limit = 100 %

FIG. 45 – SAMPLE PRINTOUT (SETPOINT REPORT)

```

Remote Modem Current Limit      = 100 %
Pulldown Demand Limit          = 100 %
Pulldown Demand Time           = 0 Min

[Skip the following section if Motor Type is not Mod A
SSS]
Liquid-Cooled Solid State Starter
-----
Local Motor Current Limit       = 100 %
Remote ISN Current Limit       = 100 %
Remote Analog Current Limit    = 100 %
Remote Digital Current Limit   = 100 %
Remote Modem Current Limit     = 100 %
Pulldown Demand Limit         = 100 %
Pulldown Demand Time          = 0 Min
Scale/Model                    = 600V,281A
Supply Voltage Range = Disabled
Full Load Amps = 150 A
Current Imbalance Check = Disabled

[Skip the following section if Motor Type is not Mod B
SSS]
Liquid-Cooled Solid State Starter
-----
Local Motor Current Limit       = 100 %
Remote ISN Current Limit       = 100 %
Remote Analog Current Limit    = 100 %
Remote Digital Current Limit   = 100 %
Remote Modem Current Limit     = 100 %
Pulldown Demand Limit         = 100 %
Pulldown Demand Time          = 0 Min
Starter Model                  = 33L
Voltage Range                  = Disabled
Full Load Amps                = 215 A
Starting Current               = 1460 A
Open SCR                       = Disabled

[Skip the following section if Motor Type is not VSD]
Variable Speed Drive
-----
Local Motor Current Limit       = 100 %
Remote ISN Current Limit       = 100 %
Remote Analog Current Limit    = 100 %
Remote Digital Current Limit   = 100 %
Remote Modem Current Limit     = 100 %
Pulldown Demand Limit         = 100 %
Pulldown Demand Time          = 0 Min
Motor HP                       = 351 HP
Power Line Frequency           = 60 Hz

[Skip the following section if Motor Type is not VSD]
Harmonic Filter Data
-----
Filter Operation               = Enabled
Motor HP                       = 351 HP
    
```

FIG. 45 – CONTINUED

```

YORK SCHEDULE
CHILLER ID 0
© 1997 - 1999 YORK international corporation
mon 21 jun 1999 1:28:25 pm

schedule = OFF

Standard Schedule
-----
Sun  StarT  = Off      Stop  = Off
MOn  Start  = 06:00 AM Stop  = 06:00 PM
Tue  Start  = 06:00 AM Stop  = 06:00 PM
Wed  Start  = 06:00 AM Stop  = 06:00 PM
Thu  Start  = 06:00 AM Stop  = 06:00 PM
Fri  Start  = 06:00 AM Stop  = 06:00 PM
Sat  Start  = Off      Stop  = Off

Exception Days
-----
15 jul 1999 start = 08:00 am stop = 08:00 pm
16 jul 1999 start = 08:00 am stop = 08:00 pm
17 jul 1999 start = 08:00 am stop = 08:00 pm
18 jul 1999 start = 08:00 am stop = 08:00 pm
    
```

3

FIG. 46 – SAMPLE PRINTOUT
(SCHEDULE REPORT)

**YORK SALES ORDER
CHILLER ID 0**

© 1997 - 1999 YORK INTERNATIONAL CORPORATION
Mon 21 jun 1999 1:28:46 PM

Order Information

Commissioning date
Job Name
Job Location
Model Number YTFBFAH6-CVJ
YORK Order Number 99102014-01
Panel Serial Number 12345678
Chiller Serial Number 12345678

Design Load - Evaporator

Passes 2
Design Working Pressure 150
Fouling Factor 0.00010
Pressure Drop 21.1
Nozzle Arrangement In 2
Nozzle Arrangement Out 3
Leaving Temperature 44.0
Return Temperature 56.0
GPM 1500.0
Tubes 181

Design Load - condenser

Passes 2
Design Working Pressure 150
Fouling Factor 0.00025
Pressure Drop 28.0
Nozzle Arrangement In 1
Nozzle Arrangement Out
Leaving Temperature 94.3
Return Temperature 85.0
GPM 2250.0
Tubes 230

Nameplate Information

Motor Code CV
Power (Volts) 460
Phases 3
Frequency (Hz) 60
Looked Rotor Amps 4400
Full Load Amps 642
Inrush Amps 655

System Information

Refrigerant R123
Tons 150
Gear Code RK
Liquid Type water
Brine Percent
Kilowatts Input 467
VSD / sss / em VSD

FIG. 47 – SAMPLE PRINTOUT (SALES ORDER REPORT)

YORK HISTORY 1
CHILLER ID 0

© 1997 - 1999 YORK INTERNATIONAL CORPORATION

MSYSTEM READY TO START
 LCSSS - LOGIC BOARD POWER SUPPLY
 [List any warnings that were active at the time of shutdown]

Controls C.MLM.02.03.102
 Run Time 0 Days 2 Hr 59 Min

Operating Hours = 294 Hr
 Number Of Starts = 105
 Control Source = Local

Evaporator

Leaving Chilled Active Setpoint = 45.0 ~F
 Chilled Liquid Pump = Stop
 Chilled Liquid Flow Switch = Open
 Leaving Chilled Liquid Temperature = 50.0 ~F
 Return Chilled Liquid Temperature = 59.3 ~F
 Evaporator Pressure = 7.2 Psia
 Evaporator Saturation Temperature = 41.1 ~F
 Evaporator Refrigerant Temperature = 40.0 ~F
 [If Refrigerant Sensor enabled]
 Small Temperature Difference = 10.0 ~F

Condenser

Condenser Liquid Pump = Stop
 Condenser Liquid Flow Switch = Open
 Leaving Condenser Liquid Temperature = 85.0 ~F
 Return Condenser Liquid Temperature = 94.9 ~F
 Condenser Pressure = 13.8 Psia
 Condenser Saturation Temperature = 71.7 ~F
 Small Temperature Difference = -13.3 ~F
 Drop Leg Refrigerant Temperature = 85.0 ~F
 [If Drop Leg Sensor enabled]
 Sub Cooling Temperature = 2.0 ~F
 [If Drop Leg Sensor enabled]

Compressor

Discharge Temperature = 121.6 ~F
 Vent Line Solenoid = Off

Oil Sump

Oil Pump Run Output = Off
 Oil Pressure = 0.0 Psid
 Oil Sump Temperature = 137.9 ~F

[Skip the following section if Hot Gas Bypass is not enabled]
 Hot Gas

Valve Position [If Hot Gas enabled] = 0 %
 Pre-Rotation Vanes Position = 0 %
 Surge

Total Surge Count = 127
 Surge Window Time = 1 Min
 Surge Window Count = 0

[Skip the following section if Liquid Level is not enabled]
 Refrigerant Level Control

Refrigerant Level Position = 35 %
 Ramp Up Time Remaining = 15 Sec
 [If Ramp Up in effect]

Purge Control

Pressure = 42.8 Psia
 Exhaust Count = 0
 Exhaust Window = 60 Min

[Skip the following section if Motor Type is not EM]
 Electro-Mechanical Starter

Motor Run = Off
 % Full Load Amps = 0 %

[Skip the following section if Motor Type is not Mod A SSS]
 Liquid-Cooled Solid State Starter

Motor Run = Off
 % Full Load Amps = 0 %
 Phase A Voltage = 447 V
 Phase B Voltage = 409 V
 Phase C Voltage = 442 V
 Phase A Current = 0 A
 Phase B Current = 0 A
 Phase C Current = 0 A

[Skip the following section if Motor Type is not Mod B SSS]
 Liquid-Cooled Solid State Starter

Motor Run = Off
 % Full Load Amps = 0 %
 Starter Model = 33L
 KW Hours = 20723 KWH
 Input Power = 145 KW
 Phase A Voltage = 447 V
 Phase B Voltage = 409 V
 Phase C Voltage = 442 V
 Phase A Current = 0 A
 Phase B Current = 0 A

3

FIG. 48 – SAMPLE PRINTOUT (HISTORY REPORT)

```
[Skip the following section if Motor Type is not VSD]
Variable Speed Drive

-----
Motor Run = Off
% Full Load Amps = 0 %
Pre-Rotation Vanes Position = 0 %
Full Load Amps = 402 A
Precharge Relay Output = Off
Trigger SCR Output = Off
Water Pump Output = Off
KW Hours = 14528 KWH
Input Power = 150 KW
Output Frequency = 0 Hz
Output Voltage = 800 V
DC Bus Voltage = 600 V
DC Inverter Link Current = 300 A
Phase A Output Current = 0 A
Phase B Output Current = 0 A
Phase C Output Current = 0 A
Internal Ambient Temperature = 88 ~F
Converter Heatsink Temperature = 102 ~F
Phase A Heatsink Temperature = 93 ~F
Phase B Heatsink Temperature = 99 ~F
Phase C Heatsink Temperature = 97 ~F

[Skip the following section if Motor Type is not VSD,
or Filter is not present]
Harmonic Filter Data

-----
Precharge Contactor = Off
Supply Contactor = Off
Operating Mode = Stopped
Phase Rotation = ABC
Total Supply KVA = 148 KVA
Total Power Factor = 0.97
DC Bus Voltage = 608 V
Heatsink Temperature = 102 ~F
Voltage Peak N-L1 = 200 V
Voltage Peak N-L2 = 200 V
Voltage Peak N-L3 = 200 V
L1-L2 RMS Voltage = 215 V
L2-L3 RMS Voltage = 215 V
L3-L1 RMS Voltage = 215 V
L1 RMS Filter Current = 150 A
L2 RMS Filter Current = 150 A
L3 RMS Filter Current = 150 A
L1 RMS Supply Current = 152 A
L2 RMS Supply Current = 152 A
L3 RMS Supply Current = 152 A
L1 Voltage Total Harmonic Distortion = 1.5 %
L2 Voltage Total Harmonic Distortion = 1.2 %
L3 Voltage Total Harmonic Distortion = 1.1 %
L1 Supply Current Total Demand Distortion = 2.6 %
L2 Supply Current Total Demand Distortion = 2.3 %
```

FIG. 48 – CONTINUED

```
YORK SETPOINT CHANGE LOG
CHILLER ID 163
© 1997 - 2000 YORK INTERNATIONAL CORPORATION
Mon 09 Oct 2000 3:33:47 PM

Log Entry 1 Evaporator - Leaving Chilled Local Setpoint

-----
Date = 05 Oct 2001
Time = 4:23:49 PM
Access Level = Service
User Id = 4268
Old Value = 46.5 ~F
New Value = 48.0 ~F

Log Entry 2 Condenser - High Pressure Warning Threshold

-----
Date = 05 Oct 2001
Time = 1:36:12 PM
Access Level = Service
User Id = 4268
Old Value = 162.5 Psig
New Value = 225.0 Psig

Log Entry 3 Condenser - Drop Leg

-----
Date = 05 Oct 2001
Time = 1:36:02 PM
Access Level = Service
User Id = 4268
Old Value = Disabled
New Value = Enabled

Log Entry 4 Evaporator - Refrigerant

-----
Date = 05 Oct 2001
Time = 1:35:48 PM
Access Level = Service
User Id = 4268
Old Value = Disabled
New Value = Enabled
```

FIG. 49 – SAMPLE PRINTOUT (SECURITY LOG)

```

YORK TREND
CHILLER ID 163
© 1997 - 2000 YORK INTERNATIONAL CORPORATION
Mon 09 Oct 2000 3:33:47 PM

Data 1: Leaving Chilled Liquid Temperature
Data 2: Return Chilled Liquid Temperature
Data 3: Evaporator Pressure
Data 4: Leaving Condenser Liquid Temperature
Data 5: Return Condenser Liquid Temperature
Data 6: Condenser Pressure

Time      Data 1  Data 2  Data 3  Data 4  Data 5  Data 6
3:33:47 PM45.5 °F55.0 °F 6.3 PSIA 95.0 °F 85.0 °F 18.7
PSIA
3:33:48 PM45.5 °F55.0 °F 6.3 PSIA 95.0 °F 85.0 °F 18.7
PSIA
3:33:49 PM45.5 °F55.0 °F 6.3 PSIA 95.0 °F 85.0 °F 18.7
PSIA
    
```

FIG. 50 – SAMPLE PRINTOUT (TREND DATA NEW OR EXISTING POINTS)

```

YORK CUSTOM VIEW
CHILLER ID 0
(c) 1997 - 2001 YORK INTERNATIONAL CORPORATION
Mon 21 Jun 1999 1:28:25 PM

Leaving Chilled Liquid Temperature      = 45.0 ~F
Return Chilled Liquid Temperature       = 55.0 ~F
Leaving Condenser Liquid Temperature    = 95.0 ~F
Return Condenser Liquid Temperature     = 85.0 ~F
Evaporator Saturation Temperature       = 41.0 ~F
Condenser Saturation Temperature        = 78.5 ~F
Evaporator Pressure                     = 17.0 Psid
Condenser Pressure                      = 64.0 Psid
Oil Pressure                             = 45.0 Psid
% Full Load Amps                        = 50 %
    
```

FIG. 51 – SAMPLE PRINTOUT (CUSTOM SCREEN REPORT)

```

Log Time: Mon 12:45:39 PM 21 Jun 1999
D-P/P= 0.92; Prv Pos= 56; Freq= 39 Hz

Surge Type                               = Delta P/P Surge
Leaving Chilled Active Setpoint          = 45.0 ~F
Leaving Chilled Liquid Temperature       = 50.0 ~F
Return Chilled Liquid Temperature        = 59.3 ~F
Leaving Condenser Liquid Temperature     = 85.0 ~F
Return Condenser Liquid Temperature      = 94.9 ~F
Evaporator Pressure                      = 7.2 Psia
Condenser Pressure                       = 13.8 Psia
% Full Load Amps                         = 94 %
    
```

FIG. 52 – SAMPLE PRINTOUT (ADAPTIVE CAPACITY CONTROL NEW MAP POINT REPORT)

```

D-P/P = 1.20; Prv Pos = 89; Freq = 58 Hz
D-P/P = 1.41; Prv Pos = 71; Freq = 46 Hz
D-P/P = 0.98; Prv Pos = 73; Freq = 52 Hz
D-P/P = 0.71; Prv Pos = 86; Freq = 39 Hz
D-P/P = 0.86; Prv Pos = 53; Freq = 48 Hz
D-P/P = 1.14; Prv Pos = 76; Freq = 51 Hz
D-P/P = 0.84; Prv Pos = 84; Freq = 37 Hz
D-P/P = 0.99; Prv Pos = 63; Freq = 46 Hz
    
```

FIG. 53 – SAMPLE PRINTOUT (ADAPTIVE CAPACITY CONTROL EXISTING MAP POINTS REPORT)

SECTION 4

SYSTEM OPERATING PROCEDURES

OIL HEATERS



If the oil heater is de-energized during a shutdown period, it must be energized for 12 hours prior to starting compressor, or remove all oil and recharge compressor with new oil. (See “Oil Charging Procedure”, page 129.)



The oil heater is thermostatically controlled and remains energized as long as the fused disconnect switch to the starter or Variable Speed Drive is energized.

CHECKING THE OIL LEVEL IN THE OIL RESERVOIR

Proper operating oil level – the middle of the upper sight glass.

If the oil is excessively high after start-up, the excess oil may be drained from the oil filter drain valve while the compressor is running.

If oil level is low, oil should be added to the compressor. (See “Oil Charging Procedure”, page 129.)



Comply with EPA and Local regulations when removing or disposing of Refrigeration System oil!

START-UP PROCEDURE

Pre-Starting

Prior to starting the chiller observe the OptiView Control Center. Make sure the Display reads “**SYSTEM READY TO START**”.

To pre-start the chiller use the following procedure:

1. **OIL HEATER** - The oil heater must be energized for 12 hours prior to starting the chiller. The unit will not start if the oil is less than 71°F. If not possible the compressor oil should be drained and new oil must be charged into the oil sump. (See “Oil Charging Procedure”, page 129)
2. **OIL PUMP** - To check, press and release the “**MANUAL OIL PUMP**” key under “**Service**” on the Control Center. The oil pump will run for 10 minutes and shut down. Press and release the “**MANUAL OIL PUMP**” key to stop the operation of the oil pump for less than 10 minutes of operation.
3. All Control Center setpoints should be programmed before the chiller is started. Prior to start, the clock must be programmed for the proper day and time. Any setpoints which are desired to be changed may be programmed. If not programmed the “default” value setpoints are as follows:

LCWT = 45°F

% Current Limit = 100% FLA

Pulldown Demand = None

Clock = Sun 12:00A.M.

Daily Schedule = None

Holiday = None

Remote Reset Temp. Range = 20°F

Data Logger = No Operation

Start-Up

1. If the chilled water pump is manually operated, start the pump. The Control Center will not allow the chiller to start unless chilled liquid flow is established through the unit. (A field supplied chilled water flow switch is required.) If the chilled liquid pump is wired to the OptiView Control Center the pump will automatically start, therefore, this step is not necessary.
2. To start the chiller, press the “**COMPRESSOR START**” switch. This switch will automatically spring return to the “**RUN**” position. (If the unit was previously started press the “**STOP/RESET**” side of the “**COMPRESSOR**” switch and then press the “**START**” side of the switch to start the chiller.) When the start switch is energized the Control Center is placed in an operating mode and any malfunction will be noted by messages on the OptiView Control Center. (See Fig. 3)

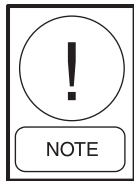

Any malfunctions which occur during “STOP/RESET” are also displayed.

When the chiller is shut down, the prerotation vanes will close automatically to prevent loading the compressor on start-up. When the chiller starts to operate, the following automatic sequences are initiated: (Refer to Fig. 54 & 55, “Operation Sequence Timing Diagram”).

1. The OptiView Control Center display message will read “**SYSTEM PRELUDE**” for the first 30 seconds of the starting sequence. (3 min. if Microboard Program Switch SW1-3 is “ON”; “OFF” = 30 seconds.)
2. The compressor vent line solenoid valve will open after the first 5 minutes of unit operation. The solenoid will close automatically after the compressor shuts down.
3. The 1R-1 contacts of the 1R start relay will remain open for the first 30 seconds of oil pump operation. These contacts will close, starting the compressor motor and the condenser water pump at the end of the 30 second period.
4. The chilled liquid pump contacts will close, starting the chilled liquid pump to allow liquid flow through the cooler when the “**COMPRESSOR**” start switch is energized.
5. After the first 30 seconds of operation, the compressor will start and the Graphic Control Center display message will read “**SYSTEM RUN**”.

Chiller Operation

After the compressor reaches its operating speed the prerotation vanes will begin to open under the control of the micro processor board or the logic section of the Variable Speed Drive which senses the leaving chilled liquid temperature. The unit capacity will vary to maintain the leaving chilled liquid temperature setpoint. The prerotation vanes are modulated by an actuator under the control of the microprocessor board or logic section of the Variable Speed Drive. The vane control routine employs proportional plus derivative (rate) control action. A drop in chilled liquid temperature will cause the actuator to close the prerotation vanes (and also decreases the speed of the motor if equipped with a

Variable Speed Drive) to decrease chiller capacity. When the chilled liquid temperature rises, the actuator will open the prerotation vanes and increase the compressor motor speed of the chiller (if controlled by the Variable Speed Drive), to increase the capacity of the unit.

However, the current draw (amperes) by the compressor motor cannot exceed the setting of the “% **CURRENT LIMIT**” at any time during the unit operation, since the Graphic Control Center 30 to 100% three phase peak current limit software function, plus the 3 phase 100% solid state overload current limiter (CM-2) on Electro-Mechanical Starter applications or the solid state starter current limit function will override the temperature control function (or the logic section of the Variable Speed Drive) and prevent the prerotation vanes from opening beyond the “% **CURRENT LIMIT**” setting.

If the load continues to decrease, after the prerotation vanes are entirely closed, the chiller will be shut down by the Low Water Temperature control (LWT) function which is displayed on the Control Center as: “**LEAVING CHILLED LIQUID – LOW TEMPERATURE**”.

This occurs when the leaving water temperature falls to programmed shutdown setpoint or 36°F, whichever is higher.

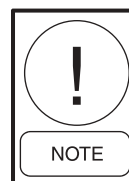

If the temperature setpoint has been reprogrammed within the last 10 minutes, the LWT cutout is 36°F for 10 minutes.

Condenser Water Temperature Control

The YORK Millennium chiller is designed to use less power by taking advantage of lower than design temperatures that are naturally produced by cooling towers throughout the operating year. Exact control of condenser water, such as a cooling tower bypass, is not necessary for most installations. The chiller requires only that the minimum condenser water temperature be no lower than the value determined by referring to Fig. 56. At start-up the entering condenser water temperature may be as much as 25°F colder than the standby return chilled water temperature. Cooling tower fan cycling will normally provide adequate control of the entering condenser water temperature on most installations.

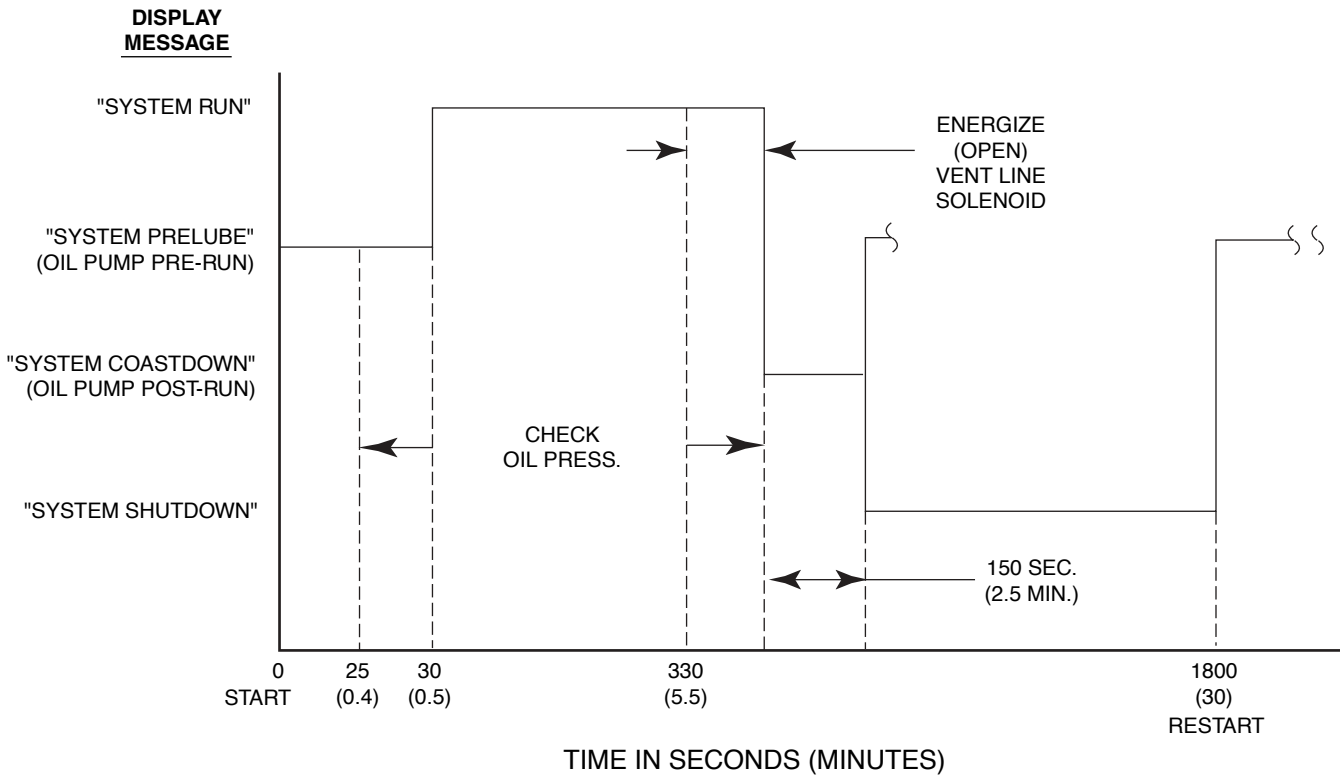

FIG. 54 – OPERATION SEQUENCE TIMING DIAGRAM (ELECTRO-MECHANICAL AND SOLID STATE STARTER APPLICATIONS)

LD04643

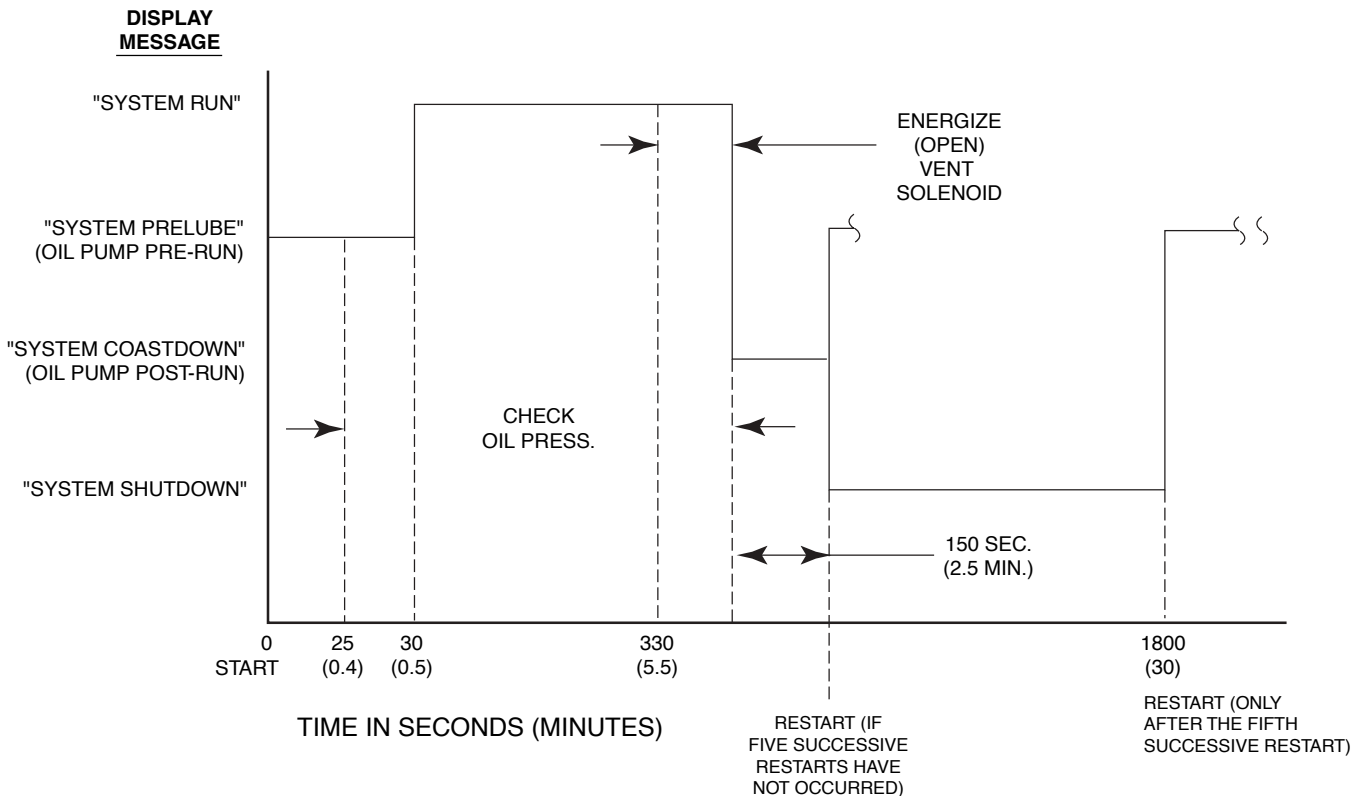
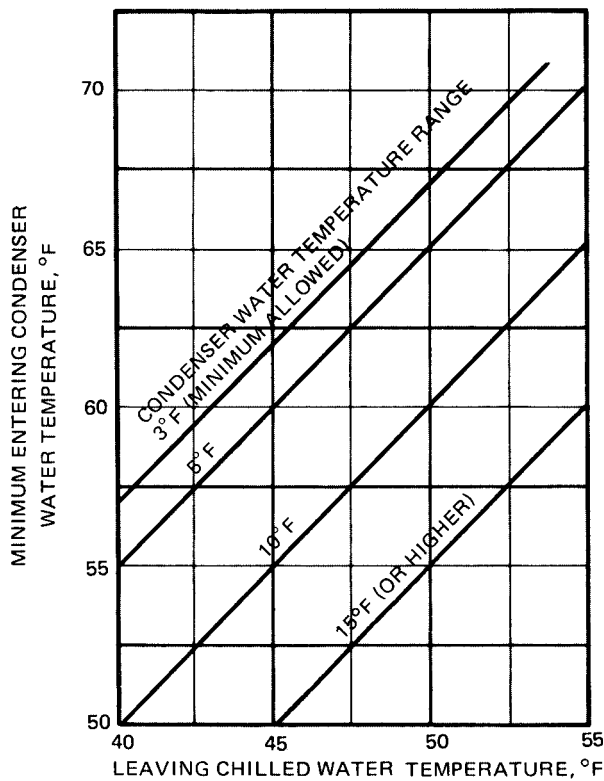

FIG. 55 – OPERATION SEQUENCE TIMING DIAGRAM (COMPRESSOR MOTOR VARIABLE SPEED DRIVE APPLICATIONS)

LD04644



LD00466

FIG. 56 – MINIMUM ENTERING CONDENSING WATER TEMPERATURE

CHECKING OPERATION

During operation, the following conditions should be periodically checked:

1. On starting, the prerotation vanes should remain closed.
2. Be sure the oil pump is operating while unit is running.
3. Check Oil Pressure display. A gradual decrease in bearing oil pressure of 5 to 10 PSI (with constant suction and discharge pressures) may be an indication of a dirty filter. The filter should be replaced when pressure loss is 30% or more of the original pressure. The actual bearing oil pressure will vary with compressor suction and discharge pressures. When a new system is first operated under normal full load conditions, the bearing oil pressure should be recorded as a reference point with which to compare subsequent readings.

4

OPERATING LOG SHEET

A permanent daily record of system operating conditions (temperatures and pressures) recorded at regular intervals throughout each 24 hour operating period should be kept.

The form is titled 'YORK Maintenance & Energy Services LIQUID CHILLER LOG SHEET'. It includes fields for 'Chiller Location' and 'System No.'. The main data area is a grid with columns for 'Date', 'Time', and various measurement categories. The categories listed are:

- Hour Meter Reading**: G.A. Temperature D.B./W.B.
- Compressor**: Oil Level, Oil Pressure, Oil Temperature, Suction Temperature, Discharge Temperature, PHV % Open
- Meter**: Volts, Amps % FLA
- Refrig.**: Suction Pressure, Inlet Temperature, Inlet Pressure, Outlet Temperature, Outlet Pressure @ (SAT TEMP), Flow Rate—GPM
- Condenser**: Discharge Pressure, Corresponding Temp @ (SAT TEMP), High Pressure Liquid Temperature, System Air—Degrees
- Water**: Inlet Temperature, Inlet Pressure, Outlet Temperature, Outlet Pressure, Flow Rate—GPM

 A 'Remarks' section is at the bottom. A large diagonal banner across the form reads 'YORK Maintenance & Energy Services LIQUID CHILLER LOG SHEETS'. At the bottom right of the banner, it says '... an Energy-Saving approach to your Service needs ...'. The form number 'FORM 160 44 P6' is printed at the bottom right.

LD00467

FORM 160 44 P6



23889A

*NOTE: These items can be printed by an electronic printer connected to the Microboard and pressing the **PRINT** key on the Keypad or automatically using the Data Logger feature.

FIG. 57 – LIQUID CHILLER LOG SHEETS

An optional status printer is available for this purpose; or, Fig. 48 shows a log sheet used by YORK personnel for recording test data on chillers. It is available from the factory in pads of 50 sheets each under Form No. 160.44-F6 and may be obtained through the nearest YORK office. Automatic data logging is possible by connecting the optional printer and programming the DATA LOGGER function.

An accurate record of readings serves as a valuable reference for operating the system. Readings taken when a system is newly installed will establish normal conditions with which to compare later readings.

For example, dirty condenser tubes may be indicated by higher than normal temperature differences between leaving condenser water and refrigerant leaving the condenser.

OPERATING INSPECTIONS

By following a regular inspection using the display readings of the OptiView Control Center, and maintenance procedure, the operator will avoid serious operating difficulty. The following list of inspections and procedures should be used as a guide.

Daily

1. Check OptiView Control Center displays.
2. If the compressor is in operation, check the bearing oil pressure by pressing “**OIL SUMP**” key to read the display on the Control Center. Also check the oil level in the oil reservoir. Drain or add oil if necessary.
3. Check entering and leaving condenser water pressure and temperatures for comparison with job design conditions. Condenser water temperatures can be checked by pressing “**CONDENSER**” display key.
4. Check the entering and leaving chilled liquid temperatures and evaporator pressure for comparison with job design conditions. This can be accomplished by pressing the “**EVAPORATOR**” key and the “**REFRIGERANT PRESSURES**” key.
5. Check the condenser saturation temperature (based upon condenser pressure sensed by the condenser transducer). Press the “**CONDENSER**” key.
6. Check the compressor discharge temperature. Press “**COMPRESSOR**” key. During normal operation discharge temperature should not exceed 220°F.

7. Check the compressor motor voltage and current (amps) at E-M starter (or Variable Speed Drive), or on the OptiView Control Center motor display for Solid State Starter units.
8. Check for any signs of dirty or fouled condenser tubes. (The temperature difference between water leaving condenser and liquid refrigerant leaving the condenser should not exceed the difference recorded for a new unit by more than 4°F.)
9. Verify proper water treatment.
10. If the chiller is controlled by a YORK Variable Speed Drive, check the operating lights on the logic section. (Refer to 160.00-O1)
11. Monitor Graphic Display for Warning Messages.

Weekly

1. Check the refrigerant charge. (See “Checking the Refrigerant Charge”, page 140)

Quarterly

1. Change the purge unit dehydrator at least quarterly, or more often if required.
2. Clean purge foul gas strainer.
3. Perform chemical analysis of oil.
4. Clean water strainer on VSD (if equipped).

Semi-Annually (or more often as required.)

1. Change and inspect compressor oil filter element.
2. Oil return system
 - a. Change dehydrator.
 - b. Check nozzle of eductor for foreign particles.
3. Check controls and safety cutouts.
4. Check level of coolant if equipped with SSS or VSD.

Annually (more often if necessary.)

1. Drain and replace the oil in the compressor oil sump (See “Oil Charging Procedure”, page 129).
2. Cooler and Condenser
 - a. Inspect and clean water strainers.
 - b. Inspect and clean tubes as required.
 - c. Inspect end sheets.
 - d. Backflush heat exchanger on VSD (if equipped).

3. Compressor Drive Motor (See motor manufacturer's maintenance and service instruction supplied with unit)
 - a. Clean air passages and windings per manufacturer's instructions.
 - b. Meg motor windings - See Fig. 65 for details.
 - c. Relubricate ball bearings.



Don't overlook motor drive end bearing located in motor support of F1, F2 compressors.

4. Purge unit.
 - a. Clean and inspect all valves.
 - b. Drain and flush purge shell.
 - c. Clean orifices.
5. Inspect and service electrical components as necessary.
6. Perform chemical analysis of system.

Every Two Years

1. If unit is equipped with SSS or VSD, flush cooling circuit and replace with new coolant solution, YORK Part # 013-02987-000.

NEED FOR PURGING THE SYSTEM

To assure satisfactory operation, it is important that these systems be kept free of moisture laden air and noncondensable gases. Air in the system usually collects in the condenser, blanketing some of the condensing surface, causing the discharge pressure and temperature to rise, resulting in high operating cost, and possibly surging, or shutdown of system by high pressure cutout. Moisture in the system causes acid formation which is destructive to internal system parts.

A Turboguard purge unit is furnished and mounted at the rear of the system (See Fig. 58). The purpose of this unit is to automatically remove the mixture of noncondensable gases and refrigerant from the top of the condenser, expel the noncondensibles to the atmosphere and return the refrigerant to the system.

IMPORTANT!
The purge unit operates continuously when the system is in operation.

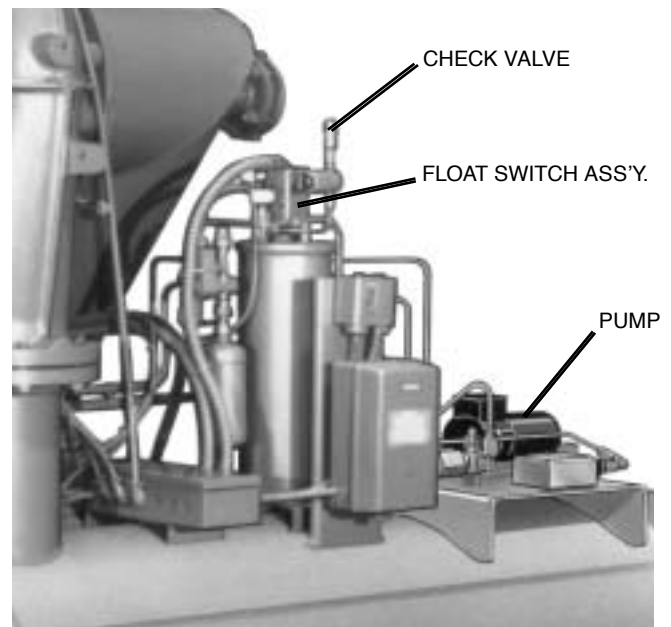

FIG. 58 – TURBOGUARD PURGE UNIT

27046A(D)

The Turboguard purge unit includes a display message on the control center display. The message reads “**WARNING – EXCESS PURGE**” if an excessive air leak is present within the chiller. The “**WARNING RESET**” should be pushed with the OptiView Control Center in “**SERVICE**” mode to reset the display. Leak check and correct the leak if the display continues to show this message.

NORMAL AND SAFETY SYSTEM SHUTDOWNS

Normal and safety system shutdowns have been built into the chiller to protect it from damage during certain operating conditions. Therefore, it should be understood that at certain pressures and temperatures the system will be stopped automatically by controls that respond to high temperatures, low temperatures, and low and high pressures, etc. The “Display Messages” section is an explanation of each specific shutdown. If the chiller shuts down on a “Safety” shutdown the cause is displayed.

STOPPING THE SYSTEM

The OptiView Control Center can be programmed to start and stop automatically (maximum, once each day) whenever desired. To stop the chiller proceed as follows:

1. Push the compressor switch to “**STOP/RESET**”. The OptiView Control Center display will show “**SYSTEM COASTDOWN**” for 150 seconds (6 min. if Microboard jumper JP36 removed). The compressor,

condenser water, and cooling tower fans will stop automatically. The oil pump will continue to run for a period of 150 seconds. The oil pump will then stop automatically. Once stopped, the “**SYSTEM COASTDOWN**” display will be replaced by “**SYSTEM READY TO START**”.

2. Stop the chilled water pump (if not wired into the OptiView Control Center, in which case it will shut off automatically simultaneously with the oil pump.) (The actual water pump contact operation is dependent upon the position of Microboard Program Switch SW1-8.)
3. Open the switch to the cooling tower fan motors, if used.
4. The compressor sump oil heater (thermostatically controlled) is energized when the unit is stopped.

PROLONGED SHUTDOWN

If the chiller is to be shut down for an extended period of time (for example, over the winter season), the following paragraphs outline the procedure to be followed.

1. After the system pressure has risen above atmospheric, test all system joints for refrigerant leaks with a leak detector. If equipment room is below 70°F, circulate hot water (not to exceed 100°F) through the cooler tubes to raise the system pressure. If any leaks are found, they should be repaired before allowing the system to stand for a long period of time.

During long idle periods, the tightness of the system should be checked periodically.

2. If freezing temperatures are encountered while the system is idle, carefully drain the cooling water from the cooling tower, condenser, condenser pump, and the chilled water system-chilled water pump and coils. Open the drains on the cooler and condenser liquid heads to assure complete drainage. (If a Variable Speed Drive, drain its water cooling system. If Solid State Starter, drain water from starter cooling loop. Isolate the Turboguard purge unit from the main system.)
3. Isolate the Turboguard purge unit from the main system.
4. Disable clock on **SETUP** Screen. This conserves the battery.
5. Open the main disconnect switches to the compressor motor, condenser water pump and the chilled water pump. Open the 115 volt circuit to the Control Center.

START UP AFTER PROLONGED SHUTDOWN

1. When putting the system into operation after prolonged shutdown (during the winter), remove all oil from the compressor. Install a new filter element and charge compressor with fresh oil. Replace purge unit and oil return filters. Enable clock on **SETUP** Screen.
2. Operate the “**OIL PUMP**” (press and release the manual oil pump key) until steady oil pressure is established. Then press and release the “**OIL PUMP**” key to stop operation of the oil pump. If the water systems were drained, fill the condenser water circuit and chilled liquid circuit.

SECTION 5

SYSTEM COMPONENTS DESCRIPTION - COMPRESSOR / MOTOR ASSEMBLY

CASING - The casing is accessible with vertical circular joints and fabricated of close-grain cast iron. The motor assembly is completely removable from the compressor rotor and scroll assembly. Compressor castings are designed for 15 PSIG working pressure and hydrostatically pressure tested at 50 PSIG.

COMPRESSOR - The rotor assembly consists of a heat treated alloy steel drive shaft (integral with pinion gear) and a lightweight, high strength, fully shrouded cast aluminum impeller. The impeller is designed for balanced thrust. The impeller is dynamically balanced to insure vibration free operation and is overspeed tested for safety.

BEARINGS - Insert type journal and thrust bearings are fabricated of aluminum alloy and are precision bored and axially grooved.

INTERNAL GEARS - Single helical gears with crowned teeth are employed so that more than one tooth is in contact at all times to provide even distribution of the compressor load with quiet operation. Gears are integrally assembled in the compressor rotor support and are oil film lubricated. Each gear is individually mounted in journal bearings with individual thrust bearings to insure proper balance of forces from the impeller and motor.

LUBRICATION SYSTEM - YORK lubricating oil is force fed to all bearings and filtered by an externally mounted 15 micron replaceable cartridge oil filter equipped with service valves. An automatic oil recovery system returns oil to the compressor that has migrated into the refrigerant system. Heat is removed from the oil by a refrigerant-cooled oil cooler, located in the evaporator. All oil piping is completely factory-installed and tested. A thermostatically controlled heater is supplied in the oil reservoir to limit the amount of refrigerant absorbed by the oil when the compressor is not operating.

Oil (under pressure) is supplied from the oil reservoir by an internally-mounted submersible oil pump. Oil Pump motors are available in 208 through 600V-3Ph-60/50 Hz to match the application and are supplied complete with starter and current sensing overloads for extra protection. The oil reservoir heater is 1000 watts, 115V-1Ph-60/50

Hz immersion type. A separate three phase power supply is required except when ordered with a YORK Solid State Starter or Variable Speed Drive. A gravity flow oil reservoir is provided to feed the bearings and gears during coast down in the event of a power failure.

CAPACITY REDUCTION - Prerotation vanes (PRV) modulate the unit capacity from 100% to 10% of design, on normal air conditioning jobs. The prerotation vanes are airfoil-shaped and made of manganese bronze. An external, electric PRV operator automatically controls the vane position through a simple, reliable linkage.

SHAFT SEAL - The compressor drive shaft seal consists of a spring-loaded, precision lapped carbon ring, high temperature elastomer O-ring static seal, and stress-relieved, precision lapped cast iron collar. The seal features a small face area and low rubbing speed. It provides an efficient seal under both Vacuum and pressure conditions. The seal is oil-flooded at all times and is pressure-lubricated during compressor operation.

OPEN MOTOR - The 3600 RPM open motor is a drip-proof, squirrel cage, induction type constructed to YORK design specifications by nationally-known manufacturers. Standard low voltage (208 through 600V-3Ph-60/50 Hz) motors are available for full-voltage (across-the-line) or reduced-voltage (solid state, star delta or auto transformer) starting. Standard high voltage (2300 through 4160V-3Ph60/50 Hz) motors are available for full-voltage (across-the-line) or reduced-voltage (primary reactor or auto transformer) starting. Open close coupled motors are built with a cast iron adapter flanged between the motor and compressor. This unique design allows the motor to be coupled to the compressor.

MOTOR TERMINAL BOX - The casing is fabricated of heavy gauge steel. There are six terminals (three for high voltage) in the terminal box. Provisions are furnished for 208 through 600 volts for three-lead types of starting (solid state, across-the-line, and auto transformer). Motor terminal lugs are furnished with the YORK Current Guard Starter and the Variable Speed Drive mounted in the power section. Overload/overcurrent transformers (CTs) are furnished as listed below; in motor terminal box, as follows:

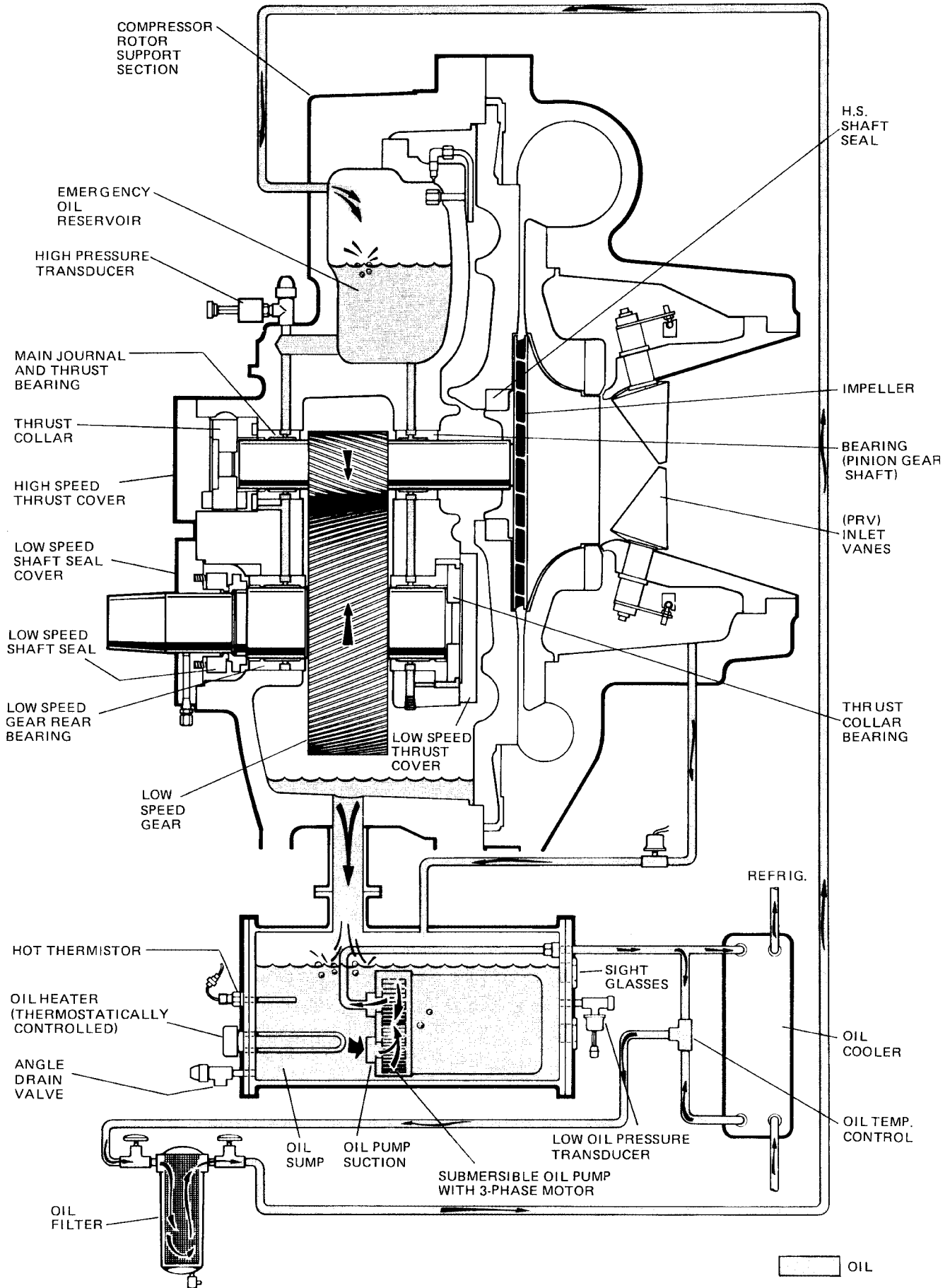

FIG. 59 – SCHEMATIC DRAWING – (YT) COMPRESSOR LUBRICATION SYSTEM

LD03278

Application	#CT's Furnished in Motor Terminal Box
E-M Starter	3
SS Starter	0
VS Drive	0

COMPRESSOR LUBRICATION SYSTEM

The chiller lubrication system consists of the oil pump, oil filter, oil cooler and all interconnecting oil piping and passages. (See Fig. 59) There are seven main points within the motor-compressor which must be supplied with forced lubrication as follows:

1. Compressor Drive Shaft (Low Speed)
 - a. Shaft seal.
 - b. Front and rear journal bearings - one on each side of driving gear.
 - c. Low speed thrust bearing (forward and reverse).
2. Compressor Driven Shaft (High Speed)
 - a. Forward and reverse high speed thrust bearing.
 - b. Three journal bearings (YDTJ67 through 95 and YDTL108 through 126). Two journal bearings (YDTL131 and 144).
3. Speed Increasing Gears
 - a. Meshing surfaces of drive and pinion gear teeth.

To provide the required amount of oil under the necessary pressure to properly lubricate these parts, a motor driven submersible oil pump is located in a remote oil sump.

Upon pressing of the “**COMPRESSOR START**” switch on the control center, the oil pump is immediately energized. After a 30 second delay to allow the system oil pressure to stabilize, the compressor motor will start. The oil pump will continue to run during the entire operation of the compressor, and for 150 seconds during compressor coastdown.

The submerged oil pump takes suction from the surrounding oil and discharges it to the oil cooler where heat is rejected. The oil flows from the oil cooler to the oil filter. The oil leaves the filter and flows to the emergency oil reservoir where it is distributed to the compressor bearings. The oil lubricates the compressor rotating components and is returned to the oil sump.

Since the emergency oil reservoir is at the highest point in the lubrication system, it provides an oil supply to the various bearings and gears in the event of a system shutdown due to power failure. The reservoir, located on

the top of the compressor, allows the oil to be distributed through the passages by gravity flow, thus providing necessary lubrication during the compressor coastdown.

OIL PUMP

For normal operation the oil pump should operate at all times during the chiller operation. Manual pump operation may be used to establish stable oil pressure before starting. When depressed and released, the “**MANUAL OIL PUMP**” key will operate the oil pump for 10 minutes and then automatically shut off. To stop the oil pump sooner, depress the “**MANUAL OIL PUMP**” key again.

On shutdown of the system for any reason, the oil pump operates and continues to run for 150 seconds. The system cannot restart during that time interval.

OIL HEATER

During long idle periods, the oil in the compressor oil reservoir tends to absorb as much refrigerant as it can hold, depending upon the temperature of the oil and the pressure in the reservoir. As the oil temperature is lowered, the amount of refrigerant absorbed will be increased. If the quantity of refrigerant in the oil becomes excessive, violent oil foaming will result as the pressure within the system is lowered on starting. This foaming is caused by refrigerant boiling out of the oil as the pressure is lowered. If this foam reaches the oil pump suction, the bearing oil pressure will fluctuate with possible temporary loss of lubrication, causing the oil pressure safety cutout to actuate and stop the system.

SHELLS - The cooler and condenser shells are rolled carbon steel plate with fusion welded seams. A thick tube sheet is welded to each end of the shell and is drilled and reamed to accommodate the tubes. All shells have a design working pressure of 15 PSIG and are pressure-tested at 30 PSIG.

TUBES - Individually-replaceable, 3/4" O.D., integral-finned copper heat exchanger tubes are used in the cooler and condenser. The tubes are roller-expanded into the tube sheets, providing a leak-proof seal.

COMPACT WATER BOXES - Removable water boxes are fabricated of steel. The standard design working pressure is 150 PSIG and the boxes are tested at 225 PSIG. Integral steel water baffles are located and welded within the water box to provide required 1, 2, or 3-pass arrangements. Water nozzle connections with

Victaulic grooves are welded to the water boxes. These nozzle connections are suitable for Victaulic couplings, welding or flanges (300 PSI has flanges). 1/2" coupling and separable well are located in the entering and leaving chilled liquid nozzles for temperature sensing elements. Plugged 1/2" or 3/4" drain and vent connections are provided in each water box.

COOLER - The cooler is a horizontal, flooded, shell-and-tube type, with a distribution system consisting of a distributor trough to give uniform distribution throughout the shell length and a perforated distributor plate, located under the entire tube bundle, to equally distribute refrigerant. Intermediate steel tube supports are spaced at intervals of less than four feet. Highly efficient, aluminum mesh eliminators are located above the tube bundle to prevent liquid refrigerant carryover into the compressor.

A liquid level sight glass is conveniently located on the side of the cooler to aid in determining proper refrigerant charge.

CONDENSER - The condenser is a horizontal, shell-and-tube type, with a discharge gas baffle to prevent direct high velocity impingement on the tubes. This baffle is also used to distribute the refrigerant gas flow properly for most efficient heat transfer. A purge connection is located in the condenser for efficient elimination of noncondensibles. Intermediate steel tube supports are spaced at intervals of less than four feet.

REFRIGERANT FLOW CONTROL - The flow control chamber is welded to the bottom of the condenser to allow complete drainage of liquid refrigerant from the condenser. The chamber contains a single fixed-orifice flow control with no moving parts.

BURSTING DISC - A 2" or 3" frangible carbon bursting disc relief device is located in the compressor suction line.

SOLID STATE STARTER (OPTIONAL)

The Solid State Starter is a reduced-voltage liquid cooled starter that controls and maintains a constant current flow to the motor during start-up. The starter is mounted on the chiller. The power wiring from the starter to the motor and from the starter control transformer to the Control Center is factory wired and tested. Available for 200-600V-3Ph-60/50 Hz power; 2 or 3 barrel lug connections per phase are provided on the starter. The starter enclosure is NEMA Type 1 and is provided with a hinged door with lock and key.

VARIABLE SPEED DRIVE (OPTIONAL)

A 460V-3ph-60/50 Hz Variable Speed Drive can be factory packaged with the chiller. It is designed to vary the compressor motor speed and prerotation vane position by controlling the frequency and voltage of the electrical power to the motor. Operational information is contained in Form 160.00-O1. The control logic automatically adjusts motor speed and compressor prerotation vane position for maximum part load efficiency by analyzing information fed to it by sensors located throughout the chiller.

SECTION 6

OPERATIONAL MAINTENANCE

OIL RETURN SYSTEM

OIL RETURN

The oil return system continuously maintains the proper oil level in the compressor oil sump. (See Fig. 57.)

High pressure condenser gas flows continuously through the eductor inducing the low pressure, oil rich liquid to flow from the evaporator, through the dehydrator to the compressor sump.

CHANGING THE DEHYDRATOR

To change the dehydrator use the following procedure:

1. Shut the stop valves on the condenser gas line, oil return line to rotor support and inlet end of dehydrator.
2. Remove the dehydrator as follows: Refer to Fig. 58.
 - a. Remove connection on the inlet end of dehydrator.
 - b. Place wrenches on the dehydrator outlet and inlet ends and the flare nut. Loosen the flare nut and unscrew the dehydrator.
3. Assemble the new filter-drier as follows:
 - a. Place the outlet and inlet ends of the dehydrator between the flare nuts.
 - b. Tighten the flare nuts.
4. Open condenser stop valve and check dehydrator connections for refrigerant leaks.
5. Open all the dehydrator stop valves to allow the liquid refrigerant to flow through the dehydrator and condenser-gas through the eductor.

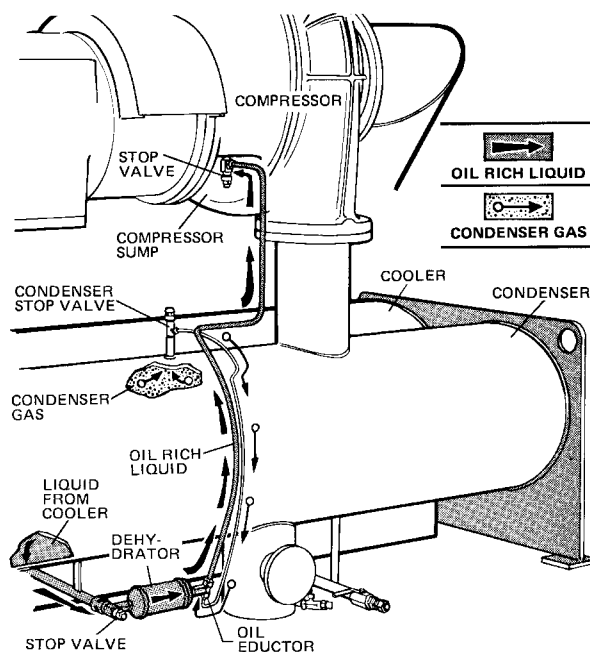

LD00469



22621A(D)

FIG. 60 – OIL RETURN SYSTEM

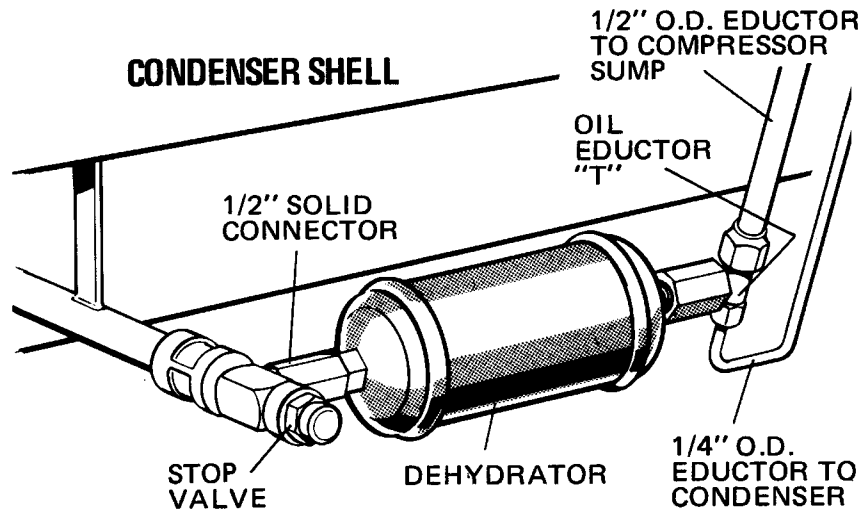

LD00470

FIG. 61 – ASSEMBLY OF DEHYDRATOR

CHARGING THE UNIT WITH OIL

The nominal oil charge for the compressor is: 10 gal. “B” and “C” compressor; 15 gal. “E” and “F” compressor.

New oil YORK Refrigeration Type “C” must be used in the centrifugal compressor. Since oil absorbs moisture when exposed to the atmosphere it should be kept tightly capped until used.

OIL CHARGING PROCEDURE

The oil should be charged into the oil reservoir using the YORK Oil Charging Pump - YORK Part No. 070-10654. To charge oil into the oil reservoir proceed as follows:

1. The unit should be shut down.



If charging oil to restore the correct level, the unit may be kept in operation.

2. Immerse the suction connection of the oil charging pump in a clean container of new oil and connect the pump discharge connection to the oil charging valve (A) located on the remote oil reservoir cover plate. (See Fig. 62). Do not tighten the connection

at the charging valve until after the air is forced out by pumping a few strokes of the oil pump. This fills the lines with oil and prevents air from being pumped into the system.

3. Open the oil charging valve and pump oil into the system until oil level in the compressor oil reservoir is about midway in the upper sight glass. Then, close the charging valve and disconnect the hand oil pump.
4. As soon as oil charging is complete, close the power supply to the starter or Variable Speed Drive to energize the oil heater. This will keep the concentration of refrigerant in the oil to a minimum.

When the oil reservoir is initially charged with oil, the oil pump should manually be started to fill the lines, passages, oil cooler and oil filter. This will lower the oil level in the reservoir. It will then be necessary to add oil to bring the level back to the center of the upper sight glass.



OIL CHARGING VALVE

25721A

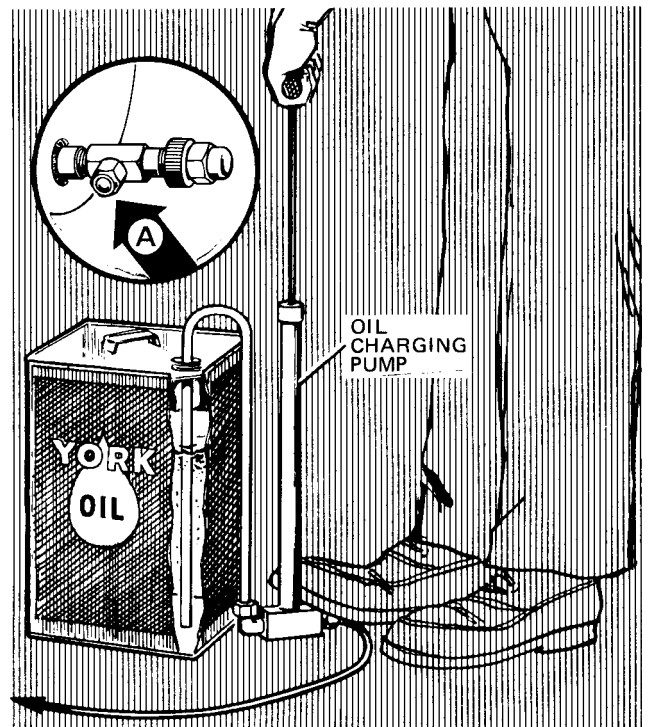

LD00472

FIG. 62 – CHARGING OIL RESERVOIR WITH OIL

SECTION 7 TROUBLE SHOOTING

TABLE 1 – CAUSES OF NORMAL AND SAFETY SYSTEM SHUTDOWNS IN ACCORDANCE WITH THE CONTROL CENTER DISPLAY

SHUTDOWN CAUSE						
DAY OF WEEK	CONTROL CENTER DISPLAY			GOVERNING CONTROL FUNCTION		
	TIME OF DAY	CAUSE OF SHUTDOWN	METHOD OF RESTART	DESCRIPTION	OPERATING POINT	
					ON RISE	ON FALL
MON.	10:00 AM	Low Water Temperature	Autostart	Low Water (LWT)	Chilled water setpoint	4°F below chilled water setpoint
MON.	10:00 AM	Low Water Temperature VSD	Autostart	Low Water (LWT)	Chilled water setpoint	4°F below chilled water setpoint
MON.	10:00 AM	Flow Switch	Autostart	Flow Switch		
MON.	10:00 AM	System Cycling	Autostart	A remote command (computer relay contact or manual switch)		
MON.	10:00 AM	Multi-Unit Cycling	Autostart	(Optional) Lead-Lag Sequence Control		
MON.	10:00 AM	Internal Clock	Autostart	Internal Clock		
MON.	10:00 AM	AC Undervoltage	Autostart	<15% FLA for 25 continuous seconds		
MON.	10:00 AM	Power Fault	Autostart	CM-2 Current Module or Solid State Starter		
		Remote Stop		Energy Management System		
MON.		Anti-Recycle, 20 Min. Left		Anti-Recycle Timer		
MON.	10:00 AM	Low Evap. Press.		Low Evap. Pressure Transducer (LEP)	5.43 PSIA	5.42 PSIA
MON.	10:00 AM	Low Evap. Press. Brine		LEP external control (Brine units only)	Set to Job Spec.	Set to Job Spec.
MON.	10:00 AM	Low Oil Pressure		Low Oil Press. Transducer (OP) High Oil Press. Transducer (OP)	20 PSID	15 PSID
MON.	10:00 AM	High Pressure		High Pressure Safety Control (HP)	15 PSIG	9 PSIG
MON.	10:00 AM	Evap. Transducer or Probe Error		Evap. Pressure Transducer or Leaving Chilled Water Thermistor (RS1)		
MON.	10:00 AM	Motor Controller - Ext. Reset		CM-2 or Solid State Starter or Variable Speed Drive		
MON.	10:00 AM	High Discharge Temperature		Discharge Temperature Thermistor (RT2)	220°F	219°F
MON.	10:00 AM	High Oil Temperature		Oil Temperature Thermistor (RT3)	180°F	179°F
MON.	10:00 AM	Power Failure	Autostart	Microboard undervoltage circuit on 5V unregulated supply	8.29VDC	7.84VDC
MON.	10:00 AM	Power Failure		Microboard undervoltage circuit on 5V unregulated supply	8.29VDC	7.84VDC

TABLE 1 – CAUSES OF NORMAL AND SAFETY SYSTEM SHUTDOWNS IN ACCORDANCE WITH THE CONTROL CENTER DISPLAY - CONTINUED

PROGRAMMED SETPOINTS BY OPERATOR	START-UP OF SYSTEM AFTER SHUTDOWN	PROBABLE CAUSE AND SERVICE REQUIRED
4°F below chilled water setpoint (If set to 40°F would be 36°F.) (36°F minimum)	Automatic Restart when water reaches setpoint. If system is running and setpoint is increased 4°F, system will continue to run, as LWT cutout shifts to a fixed 36°F for 10 minutes.	System load is less than minimum capacity.
4°F below chilled water setpoint (If set to 40°F would be 36°F.) (36°F minimum)	If system is running and setpoint is increased 4°, VSD will Initiate Shutdown. Automatic Restart when water temperature reaches setpoint.	System load is less than minimum capacity.
	Automatic Restart when water flow is restored to close flow switch.	Lack of water flow. Check operation of chilled water pump.
	Automatic Restart upon remote command.	Contact - connected to the Remote/Local cycling input of the Digital Input Board.
	Automatic Restart upon remote command.	Contact - connected to the Multi-Unit cycling input of the Digital Input Board.
Daily Schedule programmed to shut down unit.	Will automatically restart when programmed schedule permits.	Pressing Compressor Start Switch overrides the program.
		Cycling shutdown occurs when motor current is >15% FLA for 25 seconds during chiller operation.
	Will start automatically following coastdown.	Motor Controller contacts opening and closing in less than 3 seconds due to a power fault condition.
	Start up by start signal from remote start switch.	Remote Stop Contact Closure.
Will not start until 30 minute timer is timed out.	Will restart when time left = 00 minutes.	Minimum time between successive compressor starts is 30 minutes.
	To restart, press compressor switch from STOP/RESET to START position.	See OPERATING ANALYSIS, Table 2 Symptom 2.
	To restart, press compressor switch from STOP/RESET to START position.	See OPERATING ANALYSIS, Table 2 Symptom 2.
	Will restart when pressure increases to 20 PSID. To restart, press compressor switch from STOP/RESET to START position.	See OPERATING ANALYSIS, Table 2 Symptom 4, 5, 6, 7, 9, 10, 11.
	Will restart when pressure falls to 9 PSIG. To restart, press compressor switch from STOP/RESET to START position.	See OPERATING ANALYSIS, Table 2 Symptom 1 - High Discharge Pressure.
	To restart, press compressor switch from STOP/RESET to START position.	Defective Evap. Pressure Transducer or Leaving Chiller Water thermistor (RS1). LCWT minus saturation temp. is less than -2.5°F or greater than 25°F. Checked every 10 minutes following a 10-min. bypass at start-up.
	Reset the device that caused the shutdown. Chiller will start automatically.	CM-2 or Solid State Starter or Variable Speed Drive has shut down chiller.
	To restart, press compressor switch from STOP/RESET to START position.	Condenser tubes dirty or scaled or high condenser water temperature. See Symptom 1, Table 2.
	To restart, press compressor switch from STOP/RESET to START position.	Dirty oil filter or restricted oil cooler line. Change oil filter. See Symptom 9, Table 2.
Optional AUTO Restart Plug is installed on Microboard.	Will restart automatically when voltage reaches 8.29VDC. An undervoltage circuit on Microboard monitors the 5VDC unregulated supply for an undervoltage condition.	Power Failure.
Auto restart plug is removed on Microboard.	To restart, press compressor switch to STOP/RESET position and then to START position.	Power Failure.

TABLE 1 – CAUSES OF NORMAL AND SAFETY SYSTEM SHUTDOWNS IN ACCORDANCE WITH THE CONTROL CENTER DISPLAY - CONTINUED

SHUTDOWN CAUSE CONTROL CENTER DISPLAY				GOVERNING CONTROL FUNCTION		
DAY OF WEEK	TIME OF DAY	CAUSE OF SHUTDOWN	METHOD OF RESTART	DESCRIPTION	OPERATING POINT	
					ON RISE	ON FALL
MON.	10:00 AM	Oil Pressure Transducer Error		High Oil Pressure Transducer or Low Oil Pressure Transducer	60 PSID	59 PSID
		Vane Motor Switch Open	Autostart	Vane Motor Switch		
MON.	10:00 AM	Starter Malfunction Detected		Motor Current >15% for 10 seconds with Control Center not calling for motor to run.		
MON.	10:00 AM	Program Initiated Reset	Autostart	Microboard		
		Replace RTC-IC Chip Reprogram Setpoints		RTC-IC Chip		
MON.	10:00 AM	Low Oil Temperature	Autostart	Oil Temperature Thermistor (RT3)	71.0°F	55°F
MON.	10:00 AM	Faulty Discharge Temperature Sensor		Discharge Temp. Thermistor (RT2) disconnected or faulty (min. system operating temp. = 32°F)	30.0°F	29.9°F
MON.	10:00 AM	Low Line Voltage (SSS units only)		SSS Logic Board	See legend on wiring diagram.	
MON.	10:00 AM	Motor Phase Current Unbalance (SSS units only)		SSS Logic Board	See Section 2.	

TABLE 1 – CAUSES OF NORMAL AND SAFETY SYSTEM SHUTDOWNS IN ACCORDANCE WITH THE CONTROL CENTER DISPLAY - CONTINUED

PROGRAMMED SETPOINTS BY OPERATOR	START-UP OF SYSTEM AFTER SHUTDOWN	PROBABLE CAUSE AND SERVICE REQUIRED
	Will start at 59 PSID when compressor switch is placed to STOP/RESET and then START.	This Shutdown is provided to check on Oil pressure Transducers for failure in the high state. Replace Oil Pressure Transducer in oil sump or compressor.
	Restart automatically after Vane Motor arm linkage is set properly. Press STOP/RESET and then START switch.	Vaness are set improperly. Reset vane linkage, check vane positions using the Service key switch and proper keys on the OptiView Control Center or switch of capacity board of Variable Speed Drive.
	Press compressor STOP/RESET switch and then START switch.	Check motor starter operation. Motor current value greater than 15%.
		Watchdog timer circuit has reset software program. Chiller will automatically restart.
	Reprogram the Control Center Setpoints and proceed with Normal Start-up.	Weak Battery. Replace RTC-IC chip U16.
	Press STOP/RESET switch and then START switch.	Oil Temperature Thermistor disconnected from Analog Input Board. Reconnect or replace open sensor.
	Press STOP/START switch and then START switch.	Faulty Discharge Temperature Thermistor (RT2) or disconnected from Analog Input Board. Connect or replace open sensor.
	Chiller will automatically restart when all phases of line voltage increase to the minimum required starting level.	Low AC Line Voltage
	Press STOP/RESET switch and then START switch.	Motor Phase Current Unbalance

TABLE 2 – OPERATING ANALYSIS CHART

RESULTS	POSSIBLE CAUSE	REMEDY
1. SYMPTOM: ABNORMALLY HIGH DISCHARGE PRESSURE		
Temperature difference between liquid refrigerant out and water off condenser higher than normal.	Air in condenser.	Purge unit operates automatically to take care of this condition. Test for air leaks if display reads: “WARNING – EXCESS PURGE”
High discharge pressure.	Condenser tubes dirty or scaled.	Clean condenser tubes. Check water conditioning.
	High condenser water temperature.	Reduce condenser water inlet temperature. (Check cooling tower and water circulation.)
Temperature difference between condenser water on and water off higher than normal, with normal cooler pressure.	Insufficient condensing water flow.	Increase the quantity of water through the condenser to proper value.
2. SYMPTOM: ABNORMALLY LOW SUCTION PRESSURE		
Temperature difference between leaving chilled water and refrigerant in cooler greater than normal with high discharge temperature.	Insufficient charge of refrigerant. Flow orifice blocked.	Check for leaks and charge refrigerant into system. Remove obstruction.
Temperature difference between leaving chilled water and refrigerant in the cooler greater than normal with normal discharge temperature.	Cooler tubes dirty or restricted.	Clean cooler tubes.
Temperature of chilled water too low with low motor amperes.	Insufficient load for system capacity.	Check prerotation vane motor operation and setting of low water temperature cutout.
3. SYMPTOM: HIGH COOLER PRESSURE		
High chilled water temperature.	Prerotation vanes fail to open.	Check the prerotation vane motor positioning circuit.
	System overloaded.	Be sure the vanes are wide open (without overloading the motor) until the load decreases.
4. SYMPTOM: NO OIL PRESSURE WHEN SYSTEM START BUTTON PUSHED		
Low oil pressure displayed on control center; compressor will not start.	Oil pump running in wrong direction.	Check rotation of oil pump. (Electrical Connections)
	Oil pump not running.	Check electrical connections to oil pump and press manual reset on oil pump starter (on condenser shell in front of purge unit).
5. SYMPTOM: COMPRESSOR STARTS, NORMAL OIL PRESSURE DEVELOPS, FLUCTUATES FOR SHORT WHILE, THEN COMPRESSOR STOPS ON OIL PRESSURE CUTOUT		
Oil pressure normal, fluctuates, then compressor stops on Oil Pressure Cutout. Display reading: “LOW OIL PRESSURE”	Unusual starting conditions exist, i.e., oil foaming in reservoir and piping due to lowered system pressure.	Drain the oil from the compressor and charge new oil into the compressor. (See “Oil Charging Procedure”, page 129.)
	Burned out oil heater.	Replace oil heater.

TABLE 2 – OPERATING ANALYSIS CHART - CONTINUED

RESULTS	POSSIBLE CAUSE	REMEDY
6. SYMPTOM: UNUSUALLY HIGH OIL PRESSURE DEVELOPS WHEN OIL PUMP RUNS		
Unusually high oil pressure is displayed when the oil pressure display key is pressed when the oil pump is running.	High oil pressure. Transducer defective. Relief valve is misadjusted.	Replace low or high oil pressure transducer. Adjust external relief valve.
7. SYMPTOM: OIL PUMP VIBRATES OR IS NOISY		
Oil pump vibrates or is extremely noisy with some oil pressure when pressing "Oil Pressure" display key.	Misalignment of pump or piping. Mounting bolts loose. Bent shaft. Worn pump parts.	Correct condition or replace faulty part.
<i>NOTE: When oil pump is run without an oil supply it will vibrate and become extremely noisy.</i>	Oil not reaching pump suction inlet in sufficient quantity.	Check oil supply and oil piping.
8. SYMPTOM: OIL PRESSURE GRADUALLY DECREASES (NOTED BY OBSERVATION OF DAILY LOG SHEETS)		
Oil pressure (noted when pressing "Oil Pressure" display key) drops to 70% of oil pressure when compressor was originally started.	Oil filter is dirty.	Change oil filter.
	Extreme bearing wear.	Inspect compressor.
9. SYMPTOM: OIL RETURN SYSTEM CEASES TO RETURN AN OIL/REFRIGERANT SAMPLE		
Oil refrigerant return not functioning.	Filter-drier in oil return system dirty.	Replace oil filter-drier with new.
	Jet or orifice of oil return jet clogged.	Remove jet, inspect for dirt. Remove dirt using solvent and replace.
10. SYMPTOM: OIL PUMP FAILS TO DELIVER OIL PRESSURE		
No oil pressure registers when pressing "Oil Pressure" display key when oil pump runs.	Faulty oil pressure transducer. Faulty wiring/connectors.	Replace oil pressure transducer.
11. SYMPTOM: REDUCED OIL PUMP CAPACITY		
Oil pump pumping capacity low.	Excessive end clearance in pump. Other worn pump parts.	Inspect and replace worn parts.
	Partially blocked oil supply inlet.	Check oil inlet for blockage.
12. SYMPTOM: IMPROPER PURGE UNIT OPERATION		
Purge unit not purging and air is present in the unit.	1. Faulty float switch assembly. 2. Faulty three-way oil solenoid valve. 3. Faulty exhaust solenoid valve. 4. Faulty pressure transducer.	Check these components and replace where necessary.
Purge unit purging air and refrigerant	1. Faulty exhaust solenoid valve. 2. Faulty pressure transducer. 3. Lack of cooling.	Restore refrigerant liquid cooling supply.

SECTION 8 MAINTENANCE

RENEWAL PARTS

For any required Renewal Parts refer to Forms listed on page 4.

CHECKING SYSTEM FOR LEAKS

LEAK TESTING DURING OPERATION

The refrigerant side of the system is carefully pressure tested and evacuated at the factory.

After the system is in operation under load, the high pressure components should be carefully leak tested with a leak detector to be sure all joints are tight. If a leak exists frequent purging will be required or refrigerant will be lost.

If any leaks are indicated, they must be repaired immediately. Usually, leaks can be stopped by tightening flare nuts or flange bolts. However, if it is necessary to repair a welded joint, the refrigerant charge must be removed (See "Handling Refrigerant for Dismantling and Repairs", page 140).

CONDUCTING PRESSURE TEST

With the refrigerant charge removed and all known leaks repaired, the system should be charged with a small amount of R-22 mixed with dry nitrogen so that a halide torch or electronic leak detector can be used to detect any leaks too small to be found by the soap test. Do not use excessive amounts of R-22; use only enough for proper leak detection.

To test with R-22, proceed as follows:

1. With no pressure in the system, charge R-22 gas into the system through the charging valve to a pressure of 2 PSIG.
2. Build up the system pressure with dry nitrogen to approximately 10 PSIG. To be sure that the concentration of refrigerant has reached all parts of the system, slightly open the oil charging valve and test for the presence of refrigerant with a leak detector.
3. Test around each joint and factory weld. It is important that this test be thoroughly and carefully done, spending as much time as necessary and using a good leak detector.
4. To check for refrigerant leaks in the cooler and condenser, open the vents in the cooler and condenser heads and test for the presence of refrigerant. If no refrigerant is present, the tubes and tube sheets may be considered tight. If refrigerant is detected at the vents, the heads must be removed, the leak located (by means of soap test or leak detector) and repaired.
5. When absolute tightness of the system has been established, blow the mixture of nitrogen and refrigerant through the charging valve.

*GAUGE INCHES OF MERCURY (HG) BELOW ONE STANDARD ATMOSPHERE	ABSOLUTE			BOILING TEMPERATURES OF WATER °F
	PSIA	MILLIMETERS OF MERCURY (HG)	MICRONS	
0	14.696	760	760,000	212
10.24*	9.629	500	500,000	192
22.05*	3.865	200	200,000	151
25.98*	1.935	100	100,000	124
27.95*	.968	50	50,000	101
28.94*	.481	25	25,000	78
29.53*	.192	10	10,000	52
29.67*	.122	6.3	6,300	40
29.72*	.099	5	5,000	35
29.842*	.039	2	2,000	15
29.882*	.019	1.0	1,000	+1
29.901*	.010	.5	500	-11
29.917*	.002	.1	100	-38
29.919*	.001	.05	50	-50
29.9206*	.0002	.01	10	-70
29.921*	0	0	0	

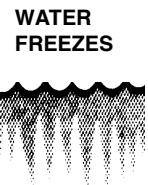

* One standard atmosphere = 14.696 PSIA
 = 760 mm Hg. absolute pressure at 32°F
 = 29.921 inches Hg. absolute at 32°F

NOTES: PSIG = Lbs. per sq. in. gauge pressure
 = Pressure above atmospheric
 PSIA = Lbs. per sq. in. absolute pressure
 = Sum of gauge plus atmospheric pressure

TABLE 3 – SYSTEM PRESSURES

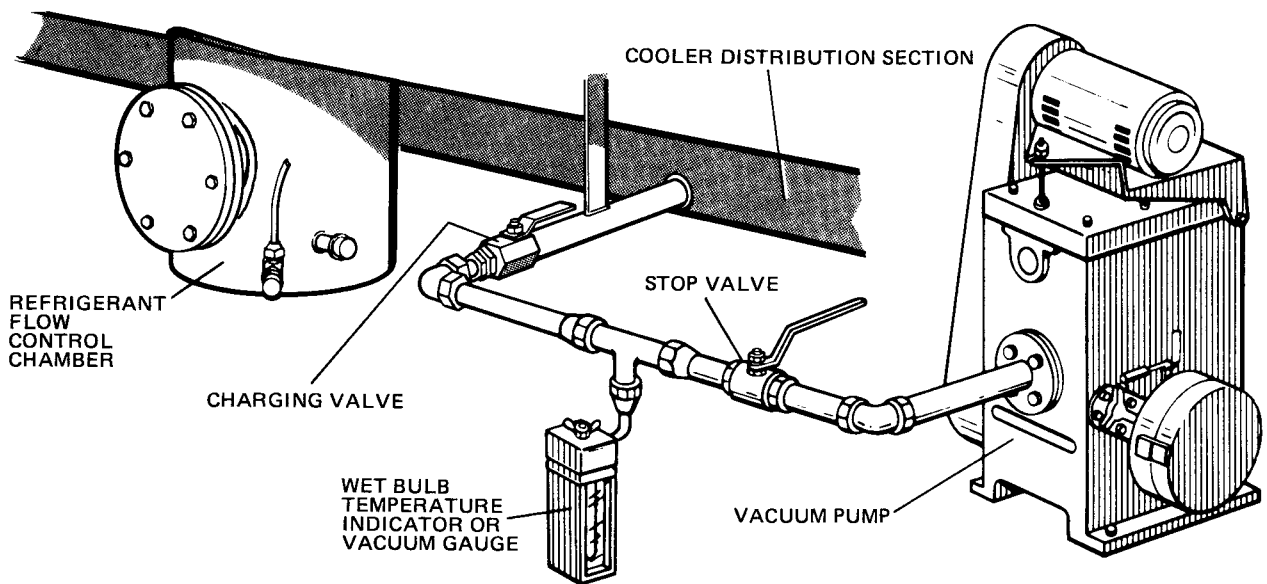

LD00473

FIG. 63 – EVACUATION OF CHILLER

EVACUATION AND DEHYDRATION OF UNIT

VACUUM TESTING

After the pressure test has been completed the Vacuum test should be conducted as follows:

1. Connect a high capacity Vacuum pump, with indicator, to the system charging valve as shown in Fig. 63 and start the pump (see "Vacuum Dehydration").
2. Open wide all system valves, including the purge and gauge valves. Be sure all valves to the atmosphere are closed.
3. Operate the Vacuum pump in accordance with "Vacuum Dehydration" until a wet bulb temperature of +32°F or a pressure of 5mm Hg. is reached. See Table 3 for corresponding values of pressure.
4. To improve evacuation circulate hot water (not to exceed 125°F) through the cooler and condenser tubes to thoroughly dehydrate the shells. If a source of hot water is not readily available, a portable water heater should be employed. **DO NOT USE STEAM.** A suggested method is to connect a hose between the source of hot water under pressure and the cooler head drain connection, out the cooler vent connection, into the condenser head drain and out the condenser vent. To avoid the possibility of causing leaks, the temperature should be brought up slowly so that the tubes and shell are heated evenly. Close the system charging valve and the stop valve between the Vacuum indicator and the Vacuum pump. (See Fig. 63) Then disconnect the Vacuum pump leaving the Vacuum indicator in place.
5. Hold the Vacuum obtained in Step 3 in the system for 8 hours; the slightest rise in pressure indicates a leak or the presence of moisture, or both. If, after 8 hours the wet bulb temperature in the Vacuum indicator has not risen above 40°F or a pressure of 6.3mm Hg, the system may be considered tight.



Be sure the Vacuum indicator is valved off while holding the system Vacuum and be sure to open the valve between the Vacuum indicator and the system when checking the Vacuum after the 8 hour period.

6. If the Vacuum does not hold for 8 hours within the limits specified in Step 5 above, the leak must be found and repaired.

VACUUM DEHYDRATION

To obtain a sufficiently dry system, the following instructions have been assembled to provide an effective method for evacuating and dehydrating a system in the field. Although there are several methods of dehydrating a system, we are recommending the following, as it produces one of the best results, and affords a means of obtaining accurate readings as to the extent of dehydration.

The equipment required to follow this method of dehydration consists of a wet bulb indicator or Vacuum gauge, a chart showing the relation between dew point temperature and pressure in inches of mercury (vacuum), (see Table 3) and a Vacuum pump capable of pumping a suitable Vacuum on the system.

OPERATION

Dehydration of a refrigeration system can be obtained by this method because the water present in the system reacts much as a refrigerant would. By pulling down the pressure in the system to a point where its saturation temperature is considerably below that of room temperature, heat will flow from the room through the walls of the system and vaporize the water, allowing a large percentage of it to be removed by the Vacuum pump. The length of time necessary for the dehydration of a system is dependent on the size or volume of the system, the capacity and efficiency of the Vacuum pump, the room temperature and the quantity of water present in the system. By the use of the Vacuum indicator as suggested, the test tube will be evacuated to the same pressure as the system, and the distilled water will be maintained at the same saturation temperature as any free water in the system, and this temperature can be observed on the thermometer.

If the system has been pressure tested and found to be tight prior to evacuation, then the saturation temperature recordings should follow a curve similar to the typical saturation curve shown as Fig. 64.

The temperature of the water in the test tube will drop as the pressure decreases, until the boiling point is reached, at which point the temperature will level off and remain at this level until all of the water in the shell is vaporized. When this final vaporization has taken place the pressure and temperature will continue to drop until eventually a temperature of 35°F or a pressure of 5mm Hg. is reached.

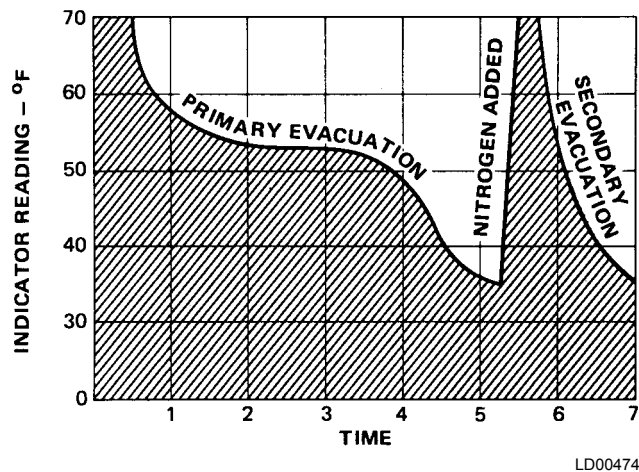

FIG. 64 – SATURATION CURVE

When this point is reached, practically all of the air has been evacuated from the system, but there is still a small amount of moisture left. In order to provide a medium for carrying this residual moisture to the Vacuum pump, nitrogen should be introduced into the system to bring

it to atmospheric pressure and the indicator temperature will return to approximately ambient temperature. Close off the system again, and start the second evacuation.

The relatively small amount of moisture left will be carried out through the Vacuum pump and the temperature or pressure shown by the indicator should drop uniformly until it reaches a temperature of 35°F or a pressure of 5mm Hg.

When the Vacuum indicator registers this temperature or pressure it is a positive sign that the system is evacuated and dehydrated to the recommended limit. If this level can not be reached, it is evident that there is a leak somewhere in the system. Any leaks must be corrected before the indicator can be pulled down to 35°F or 5mm Hg. in the primary evacuation. During the primary pulldown keep a careful watch on the wet bulb indicator temperature, and do not let it fall below 35°F. If the temperature is allowed to fall to 32°F the water in the test tube will freeze, and the result will be a faulty temperature reading.

REFRIGERANT CHARGING

To avoid the possibility of freezing the liquid within the cooler tubes when charging an evacuated system, only refrigerant vapor from the top of the drum or cylinder must be admitted to the system until the system pressure is raised above the point corresponding to the freezing point of the cooler liquid. For water, the pressure corresponding to the freezing point is 20.4 in Hg. Vacuum for R-123 (at sea level).

While charging, every precaution must be taken to prevent moisture laden air from entering the system. Make up a suitable charging connection from new copper tubing to fit between the system charging valve and the fitting on the charging drum. This connection should be as short as possible but long enough to permit sufficient flexibility for changing drums. The charging connection should be purged each time a full container of refrigerant is connected and changing containers should be done as quickly as possible to minimize the loss of refrigerant.

Refrigerant may be furnished in drums containing either 100, 200 or 650 lbs. of refrigerant. These drums are not returnable and they should be stored for future use if it should ever become necessary to remove refrigerant from the system.

TABLE 4 – REFRIGERANT CHARGE

SHELL CODES		FACTORY CHARGE LBS.	SHIPPED
COOLER	COMPRESSOR		
G0, G1, G3	B	890	900
G0, G1, G3	C	890	900
H1, H3	–	970	975
J1, J3	–	1130	1125
K1, K3	–	1270	1275
G0, G1, G3	E	890	900
H1, H3	–	970	975
J1, J3	–	1130	1125
K1, K3	–	1270	1275
L1, L3	–	1390	1400
K4, K6	F	1390	1400
K7, K9	–	1530	1550
L4, L6	–	1590	1600

CHECKING THE REFRIGERANT CHARGE DURING UNIT SHUT DOWN

The refrigerant charge is specified for each chiller model (See Table 4). Charge the correct amount of refrigerant and record the level in the cooler sight glass.

The refrigerant charge should always be checked and trimmed when the system is shut down.

The refrigerant charge level must be checked after the pressure and temperature has equalized between the

condenser and cooler. This would be expected to be 4 hours or more after the compressor and water pumps are stopped. The level should be at the center of the sight glass $\pm 1/4$ inch.

Charge the refrigerant in accordance with the method shown under "Refrigerant Charging" above. The refrigerant level should be observed and the level recorded after initial charging.

HANDLING REFRIGERANT FOR DISMANTLING AND REPAIRS

If it becomes necessary to open any part of the refrigerant system for repairs, the following paragraphs outline the procedure for handling the refrigerant while the system is open.

Since Refrigerant-123 boils at 82°F under atmospheric pressure, it will not be necessary to remove the refrigerant if the system is to be open for only a few hours. Any part of the system which is above the liquid level will be accessible without disturbing the refrigerant charge.

If the system must remain open for more than a few hours the refrigerant should be drained and stored in

clean drums for the duration of the repair period.

If conditions permit, the system pressure should be as near as possible to atmospheric before opening the system and the refrigerant charge should be kept as near as possible to 82°F to keep either the refrigerant loss or the air intake to a minimum. After the system has been re-assembled, the air should be removed by means of the purge unit. (See "Purging the System".)

MEGGING THE MOTOR

While the main disconnect switch and compressor motor starter are open, meg the motor as follows:

1. Using a megohm meter (megger), meg between phases and each phase to ground (see Fig. 65); these readings are to be interpreted using the graph shown in Fig. 66.

2. If readings fall below shaded area, remove external leads from motor and repeat test.

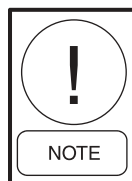

Motor is to be megged with the starter at ambient temperature after 24 hours of idle standby.

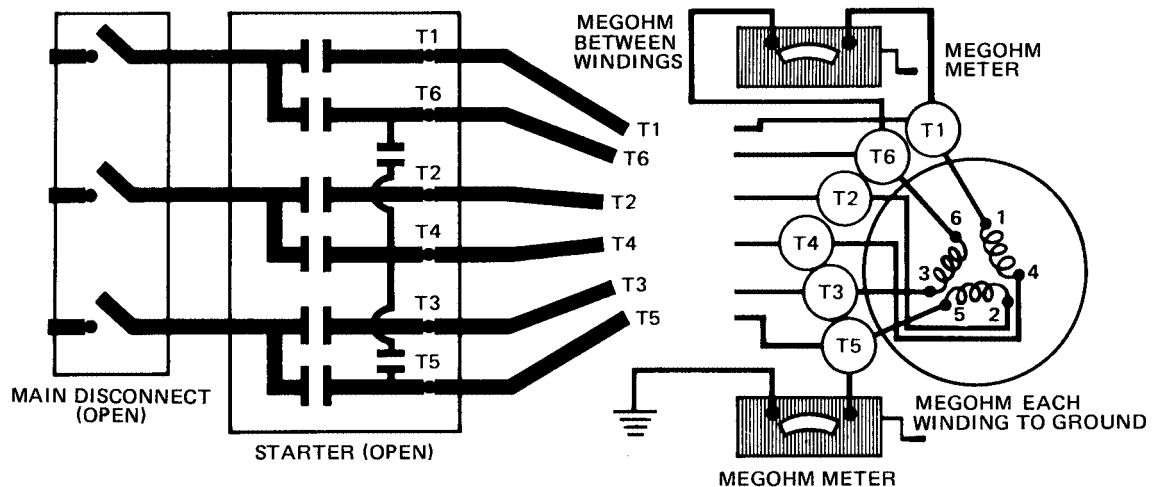

LD00475

FIG. 65 – DIAGRAM, MEGGING MOTOR WINDINGS

CONDENSERS AND COOLERS

GENERAL

Maintenance of condenser and cooler shells is important to provide trouble free operation of the chiller. The water side of the tubes in the shell must be kept clean and free from scale. Proper maintenance such as tube cleaning, and testing for leaks, is covered on the following pages.

CHEMICAL WATER TREATMENT

Since the mineral content of the water circulated through coolers and condensers varies with almost every source of supply, it is possible that the water being used may corrode the tubes or deposit heat resistant scale in them. Reliable water treatment companies are available in most larger cities to supply a water treating process which will greatly reduce the corrosive and scale forming properties of almost any type of water.

As a preventive measure against scale and corrosion and to prolong the life of cooler and condenser tubes, a chemical analysis of the water should be made preferably before the system is installed. A reliable water treatment company can be consulted to determine whether water treatment is necessary, and if so, to furnish the proper treatment for the particular water condition.

CLEANING COOLER AND CONDENSER TUBES

Cooler

It is difficult to determine by any particular test whether possible lack of performance of the water cooler is due to fouled tubes alone or due to a combination of troubles. Trouble which may be due to fouled tubes is indicated

when, over a period of time, the cooling capacity decreases and the split (temperature difference between water leaving the cooler and the refrigerant temperature in the cooler) increases. A gradual drop-off in cooling capacity can also be caused by a gradual leak of refrigerant from the system or by a combination of fouled tubes and shortage of refrigerant charge. An excessive quantity of oil in the cooler can also contribute to erratic performance.

Condenser

In a condenser, trouble due to fouled tubes is usually indicated by a steady rise in head pressure, over a period of time, accompanied by a steady rise in condensing temperature, and noisy operation. These symptoms may also be due to foul gas buildup. Purging will remove the foul gas revealing the effect of fouling.

TUBE FOULING

Fouling of the tubes can be due to deposits of two types as follows:

1. Rust or sludge, which finds its way into the tubes and accumulates there. This material usually does not build up on the inner tube surfaces as scale, but does interfere with heat transfer. Rust or sludge can generally be removed from the tubes by a thorough brushing process.
2. Scale, due to mineral deposits. These deposits, even though very thin and scarcely detectable upon physical inspection, are highly resistant to heat transfer. They can be removed most effectively by circulating an acid solution through the tubes.

**Minimum Insulation Resistance vs. Temperature (per IEEE Std 43)
Open Motors**

1. Megger readings should be taken after Megger voltage has been applied one minute.
2. If insulation resistance lies to the right of the applicable curve the motor is acceptable for use.
3. If insulation resistance lies to the left of the applicable curve, the motor should not be run. The motor should be heated to 250°F in an effort to remove moisture and obtain an acceptable reading at room ambient. This can be done either by baking in a forced hot air oven or, if proper voltage is available, apply 5 - 10% of rated voltage to motor windings.
4. Any gradual or abrupt decrease in Megger readings over an extended period of time is an indication of deterioration of insulation and / or moisture absorption or oil / dirt contamination.
5. Megger readings of individual phase coils of 200 - 600V motors should be made with coils not under test being grounded.

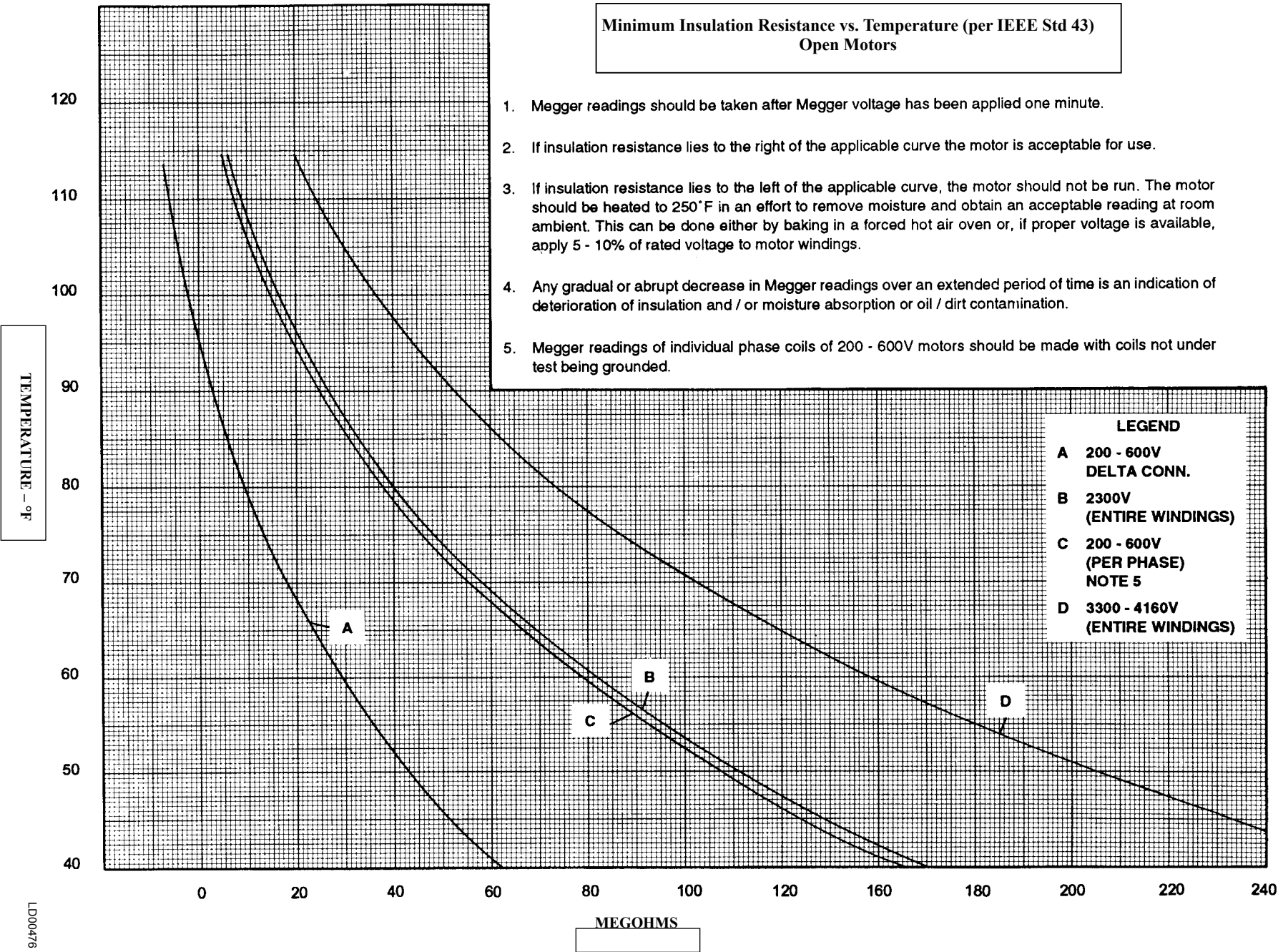

FIG. 66 – MOTOR STATOR TEMPERATURE AND INSULATION RESISTANCES

TUBE CLEANING PROCEDURES

Brush Cleaning of Tube

If the tube fouling consists of dirt and sludge, it can usually be removed by means of the brushing process. Drain the water sides of the circuit to be cleaned (cooling water or chilled water) remove the heads and thoroughly clean each tube with a soft bristle bronze brush. **DO NOT USE A STEEL BRISTLE BRUSH.** A steel brush may damage the tubes.

Improved results can be obtained by admitting water into the tube during the cleaning process. This can be done by mounting the brush on a suitable length of 1/8" pipe with a few small holes at the brush end and connecting the other end by means of a hose to the water supply.

The tubes should always be brush cleaned before acid cleaning.

Acid Cleaning of Tubes

If the tubes are fouled with a hard scale deposit, they must be acid cleaned. It is important that before acid cleaning, the tubes be cleaned by the brushing process described above. If the relatively loose foreign material is removed before the acid cleaning, the acid solution will have less material to dissolve and flush from the tubes with the result that a more satisfactory cleaning job will be accomplished with a probable saving of time.

COMMERCIAL ACID CLEANING

In many major cities, commercial organizations now offer a specialized service of acid cleaning coolers and condensers. If acid cleaning is required, YORK recommends the use of this type of organization. The Dow Industries Service Division of the Dow Chemical Company, Tulsa, Oklahoma, with branches in principal cities is one of the most reliable of these companies.

TESTING FOR COOLER AND CONDENSER TUBE LEAKS

Cooler and condenser tube leaks may result in refrigerant leaking into the water circuit, or water leaking into the shell depending on the pressure levels. If refrigerant is leaking into the water it can be detected at the liquid head vents after a period of shutdown. If water is leaking into the refrigerant, frequent purging will be necessary and system capacity and efficiency will drop off sharply. If a tube is leaking and water has entered the system, the cooler and condenser should be valved off from the rest of the water circuit and drained immediately to prevent severe rusting and corrosion. If a tube leak is indicated, the exact location of the leak may be determined as follows:

1. Allow the system to warm up until a substantial pressure is reached for testing. Dry nitrogen (pressure not to exceed 12 PSIG) may be admitted to the unit to increase pressure in the shell. Remove the heads and listen at each section of tubes for a hissing sound that would indicate gas leakage. This will assist in locating the section of tubes to be further investigated. If the probable location of the leaky tubes has been determined, treat that section in the following manner (if the location is not definite, all the tubes will require investigation).
2. Wash off both tube heads and the ends of all tubes with water.



Do not use carbon tetrachloride for this purpose since its fumes give the same same discoloration that the refrigerant does.

3. With nitrogen or dry air blow out the tubes to clear them of traces of refrigerant laden moisture from the circulation water. As soon as the tubes are clear, a cork should be driven into each end of the tube. Repeat this with all of the other tubes in the suspected section or if necessary, with all the tubes in the cooler or condenser. Allow the cooler or condenser to remain corked up to 12 to 24 hours before proceeding. Depending upon the amount of leakage, the corks may blow from the end of a tube, indicating the location of the leakage. If not, it will be necessary to make a very thorough test with the halide torch.
4. After the tubes have been corked for 12 to 24 hours, it is recommended that two men working at both ends of the cooler carefully test each tube - one man removing corks at one end and the other at the opposite end to remove corks and handle the test torch. Start with the top row of tubes in the section being investigated, remove the corks at the ends of one tube simultaneously and insert the exploring tube for 5 seconds - this should be long enough to draw into the detector any refrigerant gas that might have leaked through the tube walls. A fan placed at the end of the cooler opposite the torch will assure that any leakage will travel through the tube to the torch.
5. Mark any leaking tubes for later identification.
6. If any of the tube sheet joints are leaking, the leak should be detected by the test torch. If a tube sheet leak is suspected, its exact location may be found by using a soap solution. A continuous buildup of bubbles around a tube indicates a tube sheet leak.

COMPRESSOR

Maintenance for the compressor assembly consists of checking the operation of the oil return system and changing the dehydrator, checking and changing the oil, checking and changing the oil filters, checking the operation of the oil heater, checking the operation of the oil pump and observing the operation of the compressor.

Internal wearing of compressor parts could be a serious problem caused by improper lubrication, brought about by restricted oil lines, passages or dirty oil filters. If the unit is shutting down on (HOT) High Oil Temperature or Low Oil Pressure (OP), change the oil filter element.

Examine the oil filter element for the presence of aluminum particles. Aluminum gas seal rings can contact the impeller and account for some aluminum particles to accumulate in the oil filter, especially during the initial start up and first several months of operation. However, if aluminum particles continue to accumulate and the same conditions continue to stop the unit operation after a new filter element is installed, notify the nearest YORK office to request the presence of a YORK Service Technician.

ELECTRICAL CONTROLS

For information covering the OptiView Control Center operation, refer to "Section 2". The operating points of the pressure and temperature cut outs are shown in

the Wiring Diagrams. These diagrams also contain a starting and stopping sequence and timing sequence diagram.

SECTION 9 PREVENTIVE MAINTENANCE

It is the responsibility of the owner to provide the necessary daily, monthly and yearly maintenance requirements of the system. **IMPORTANT:** If a unit failure occurs due to improper maintenance during the warranty period; YORK will not be liable for costs incurred to return the system to satisfactory operation.

In any operating system it is most important to provide a planned maintenance and inspection of its functioning parts to keep it operating at its peak efficiency. Therefore, the following maintenance should be performed when prescribed.

COMPRESSOR

Oil Filter



Oil Filter: On all new chiller start-ups, the oil filter must be changed after the first 200 hours of operation and again at 500 hours of operation to insure proper lubrication quality for the compressor. These filters should be inspected for excessive debris, and if found containing excessive debris, report this to the local YORK Engineered

Systems's Service of ce for evaluation. After the 500 hour replacement, the oil filter should be replaced semi-annually, or when the operating oil pressure drops 30% from the oil pressure measured at the time of the previous replacement.

COMPRESSOR MOTOR

1. Check motor mounting screws frequently to insure tightness.
2. Meg motor windings annually to check for deterioration of windings.

PRESSURE TESTING

The chiller should be pressure tested annually. Any leaks found must be repaired immediately. If frequent purging has occurred, the unit must be pressure tested as soon as possible to prevent air and moisture from entering the unit. Air and moisture are the worst enemies of the R-123 system and experience has shown that units which are maintained tight, are systems that will provide trouble free efficient operation.

COOLER AND CONDENSER

The major portion of maintenance on the condenser and cooler will deal with the maintaining of the water side of the condenser and cooler in a clean condition.

The use of untreated water in cooling towers, closed water systems, etc. frequently results in one or more of the following:

1. Scale Formation
2. Corrosion or Rusting
3. Slime and Algae Formation

It is therefore to the benefit of the user to provide for proper water treatment to provide for a longer and more economical life of the equipment. The following recommendation should be followed in determining the condition of the water side of the condenser and cooler tubes.

1. The condenser tubes should be cleaned annually or earlier if conditions warrant. If the temperature difference between the water off the condenser and the condenser liquid temperature is more than 4° greater than the difference recorded on a new unit it is a good indication that the condenser tubes require cleaning. They should be cleaned as instructed on page 143 of this manual.
2. The cooler tubes under normal circumstances will not require cleaning. If however the temperature difference between the refrigerant and the chilled water increases slowly over the operating season, it is an indication that the cooler tubes may be fouling or that there may be a water by-pass in the water box requiring gasket replacement.

PURGE UNIT

Every Three Months

1. Change the purge unit dehydrator.
 - a. If the unit is operating;
 - 1) When the purge unit is in the drain cycle, close the valve in the high pressure oil supply line and allow the unit to complete the drain cycle.

- 2) Close condenser gas and oil return valves and replace the dehydrator.
- 3) Open all valves to return the purge unit to normal operation.

Annually

1. Clean and inspect all valves which are part of the purge unit system.
2. Drain and flush the oil and refrigerant from the purge unit shell.
 - a. Before flushing remove the float assembly from the purge unit shell.
 - b. Disconnect the oil line from the bottom of the purge unit shell.
 - c. To clean - flush refrigerant from the top of the purge unit shell and let the refrigerant drain from the bottom through the oil line connection.
 - d. After a complete flushing, replace the float assembly and the oil drain line.
3. Clean the following orifice.
 - a. One (1) orifice in the liquid line feed to the cooling coil.
 - b. Purge unit exhaust orifice.
4. Inspect the foul gas inlet check valve.

OIL RETURN SYSTEM

1. Change the dehydrator in the oil return system semi-annually or earlier if the oil return system fails to operate.
2. When the dehydrator is changed the nozzle of the eductor should be checked for any foreign particles that may be obstructing the jet.

ELECTRICAL CONTROLS

1. All electrical controls should be inspected for obvious malfunctions.
2. It is important that the factory settings of controls (operation and safety) not be changed. If the settings are changed without YORK's approval the warranty will be jeopardized.
3. A 5-11 year life battery is part of the RTC-Real Time Clock. To replace refer to Section 2.

SECTION 10

OPTISAVE ENERGY ANALYSER FEATURE

The **OptiSave Energy Analyzer Feature** reveals the advantage of a compressor motor variable speed drive. It calculates the amount of energy that has been saved by having a variable speed drive instead of a constant speed drive. The savings are determined by calculating the energy consumption of a constant speed drive and subtracting the measured energy consumption of the variable speed drive. The resulting difference is the energy savings.

This data is displayed but does not affect chiller operation or performance. This feature is available in software versions C.MLM.02.05.xxx (and later) and C.OPT.02.05.301 (and later). It is not operational until enabled using a special procedure. A complete description and all required installation, enable and setup information is contained in YORK Service Information Letter SI0068.

NOTES

